



# Makita















2019  
/ 2020

SORTIMENT  
PRÍSLUŠENSTVA





# Obsah

	vŕtanie, sekane	4
	skrutkovanie	122
	diamantové rezanie	138
	rezanie, obrusovanie, strihanie	149
	hobľovanie	180
	pílenie	183
	frézovanie	223
	brúsenie, leštenie	245
	klincovanie, sponkovanie	273
	meranie	281
	odsávanie	284
	svietenie, nahrievanie	304
	záhrada	309
	odkladacie systémy, kufre, uhlíky, baterky, nabíjačky	327



Typ Bosch stopka vrtákov, sekáčov SDS-plus		HR2611FT	
Typ Bosch stopka sekáčov SDS-plus so šesť hranným telom		HR2400/HR160D	
Typ Bosch stopka vrtákov, sekáčov SDS-max		HR4013C	
Typ Bosch stopka vrtákov veľký klinový hriadeľ		HR3520B/HR3850B/HR5000	
stopka vrtákov Makita 6-hranná, šírka 13mm		8035NB/HR3510/HR3520/HR3850	
stopka vrtákov Makita 6-hranná, šírka 17mm		HM0810T	
Typ Kango stopka vrtákov 19 mm		HR3850K/HR500K	
Typ Kango stopka vrtákov 19 mm		HM1200K/HR3850K/HR500K	
Typ Bosch stopka sekáčov 19 mm bez odsadeného nákrúžku		HM1200B	
Typ Bosch stopka sekáčov 19 mm s odsadeným nákrúžkom		HM0810B	
stopka sekáčov Makita 6-hranná, šírka 19mm		HK1800/HK1810	
stopka sekáčov Makita 6-hranná, šírka 21mm		HM1200	
Typ Bosch stopka sekáčov 6-hranná, šírka 28mm		HM1810/HM1801/HM1800/HM1307CB/ HM1304B/HM1303B/HM1802/HM1812	
stopka sekáčov Makita 6-hranná, šírka 30mm		HM1317C/HM1307C/HM1304	
stopka sekáčov Makita 6-hranná, šírka 30mm pre HM1400		HM1400 (hriadeľ otočná o 90°)	





# System MAXCONNET

## Príklepové vrtáky SDS-plus S4



Kritériá kvality: Ako každý iný nadstavec, aj MaxConnect si vyžaduje špeciálnu údržbu a čistenie. Preto si pozrite návod na používanie adaptéra MaxConnect.



objednávacie číslo	veľkosť (mm)	popis	cena s DPH
P-53920	320	predĺženie SDS-MAX = SDS-MAX	30,41 €
P-53936	750	predĺženie SDS-MAX = SDS-MAX	37,97 €
P-53942	1100	predĺženie SDS-MAX = SDS-MAX	51,06 €
P-53914	Ø 30 x 190	Adaptér SDS-MAX	225,87 €
P-53958	320	predĺženie BOSCH s klin. hriadeľom = SDS-MAX	33,75 €
P-53964	750	predĺženie BOSCH s klin. hriadeľom = SDS-MAX	41,03 €
P-56889	320	predĺženie 13 mm šesťhran = SDS-MAX	32,71 €
P-56895	750	predĺženie 13 mm šesťhran = SDS-MAX	42,73 €
P-56904	320	predĺženie 19 mm šesťhran = SDS-MAX	32,71 €
P-56910	750	predĺženie 19 mm šesťhran = SDS-MAX	42,73 €

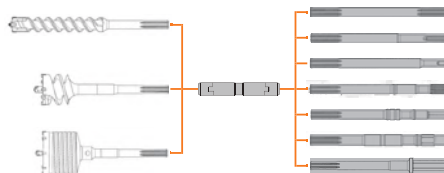

### Príznyky poškodenia:

Zvýšené opotrebenie na konci nástroja

Príčina:  
Nesprávne používanie, vrtanie dier < 32 mm

Záručná zodpovednosť:  
Neakceptovaná







### Príznyky poškodenia:

Adaptér je značne znečistený, klzná objímka sa zadrháva

Príčina:  
Nedostatočný servis a údržba

Záručná zodpovednosť:  
Neakceptovaná

príklepové vrtáky SDS-PLUS

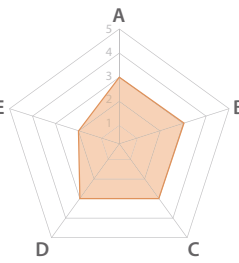
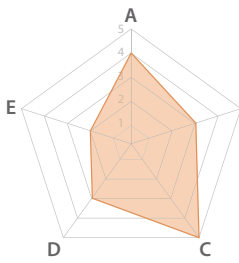
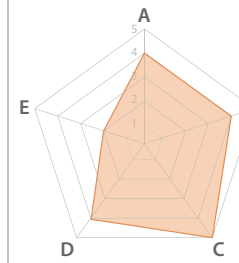
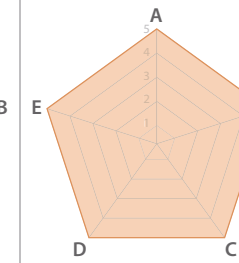
produkt	štandard	stredový hrot	stredový hrot V-PLUS	NEMESIS II
kvalita	★★	★★★	★★★★	★★★★★
hlava vrtáka z karbidu				
typ	2 brit	stredový hrot 2 brit	stredový hrot 2 brit	4 brit
drážka	2 štandardné	2 štandardné	2 drážky vysokej kvality	4 drážky vysokej kvality
graf				

graf  
 A – rýchlosť  
 B – životnosť  
 C – presnosť osadenia vrtáka  
 D – presnosť vrtania  
 E – odolnosť proti zaseknutiu



Novinka

NEMESIS II pre SDS-PLUS kladivá  
 hlava vrtáku z tvrdého karbidu



dlhšia životnosť až o 50%

životnosť (vrtanie do železobetónu)

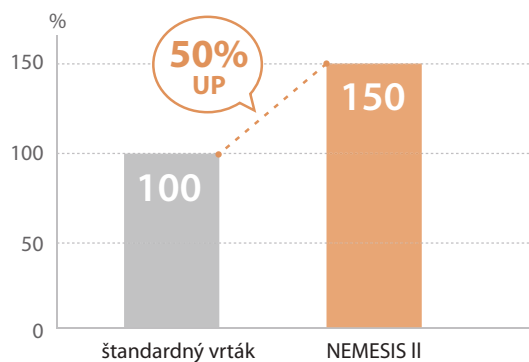

funkčnosť

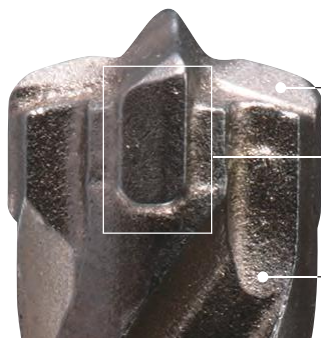

znak opotrebovania  
 upozorňuje na opotrebenie vrtáka

Innovated flute geometry  
 Faster drilling

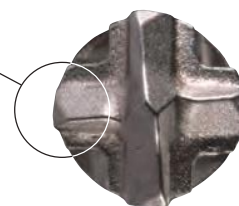

sklon hlavy vrtáka  
 eliminuje zaseknutia  
 vrtáka pri vrtaní do  
 železobetónu

# Štvorbrité SDS-Plus vrtáky NEMESIS II

NEMESIS II je spojením novátorskej geometrie a prvotriednej kvality s dôrazom na detaily. Prejavuje sa to vo výrazne dlhšej životnosti, presnom vrtaní otvorov a výnimočne nízkych vibráciách, a to aj pri veľmi náročnom vrtaní. Prvotriedny nástroj pre každého, kto vrtá do železobetónu alebo do prírodného kameňa.

## NEMESIS II

## RIEŠI PROBLÉMY

NEMESIS II dokáže vrtáť aj do najtvrdšieho prírodného kameňa a zamedzuje tak možnosti uviaznutia vrtáku pri vrtaní do železobetónu.

## VRTA PRESNEJŠIE

Jeho unikátna symetrická hlava zaisťuje veľmi presné vrtanie.

## DLHŠIA VÝDRŽ

NEMESIS II vyvrta až o 50 % viac otvorov pre kotviace prvky ako iné vrtáky.



Špeciálna vysokoakostná oceľ z ktorej je vyrobená hlava vrtáku je extrémne odolná voči ohybovým zlomom. Špeciálna povrchová úprava zvyšuje taktiež jej celkovú odolnosť.



Vďaka optimálnej symetrii 4 x 90° majú všetky karbidové vrtacie brity rovnomerný záber a nezaseknú sa ani pri kontakte s oceľovou výstužou.



Bočná výstuž a maximálna možná styčná plocha medzi karbidovým hrotom a oceľovým telom kompenzujú torzné sily.



Stredový hrot pre jednoduché bodové vrtanie s dokonalou presnosťou bez potreby predvrtania.



PGM pečať zaručuje presné vrtanie otvorov pre kotviace prvky počas celej doby životnosti vrtáka.



Štyri symetricky pracujúce špirálové chrbty zabezpečujú nízke a rovnomerné opotrebenie žliabkov.



Optimalizovaná pevnosť žliabkového jadra zaisťuje nízke vibrácie pri vrtaní a výnimočnú odolnosť proti lámaniu.

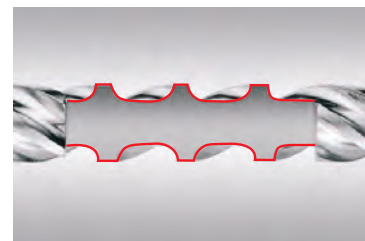

Veľkoobjemová geometria žliabkov zabezpečuje optimálny odvod prachu vznikajúceho pri vrtaní.





# Príklepové vrtáky SDS-plus

## SDS-Plus vrtáky NEMESIS II



Štvorbřitý vrták SDS Plus. Odolnejší proti opotrebovaniu.  
Rýchle a presné vrtanie. Optimálne vrtanie cez armatúru.  
Štyri kanáliky na odvod prachu.



objednávacie číslo	ø (mm)	celková dĺžka (mm)	pracovná dĺžka (mm)	cena s DPH
B-57897	5	115	50	4,80 €
B-57906	5	165	100	5,12 €
B-57912	5	215	150	7,54 €
B-57928	5	265	200	7,70 €
B-57934	5	315	250	13,22 €
B-57940	5,5	115	50	4,83 €
B-57956	5,5	165	100	5,16 €
B-57962	6	115	50	4,86 €
B-57978	6	165	100	5,19 €
B-57984	6	215	150	6,76 €
B-57990	6	265	200	8,36 €
B-58001	6	315	250	11,59 €
B-58023	6,5	165	100	6,82 €
B-58039	6,5	215	150	9,20 €
B-58045	6,5	265	200	11,85 €
B-58051	6,5	315	250	13,84 €
B-58067	7	115	50	6,50 €
B-58073	7	165	100	6,85 €
B-58089	7	215	150	8,42 €
B-58095	8	115	50	5,61 €
B-58104	8	165	100	5,97 €
B-58110	8	215	150	6,79 €
B-58126	8	265	200	8,36 €
B-58132	8	315	250	11,06 €
B-58154	8	465	400	18,15 €
B-58176	9	165	100	6,40 €
B-58182	9	265	200	8,16 €
B-58198	10	115	50	6,07 €
B-58207	10	165	100	6,59 €
B-58213	10	215	150	7,54 €
B-58229	10	265	200	8,81 €
B-58235	10	315	250	10,87 €
B-58257	10	455	390	19,22 €
B-58263	10	600	540	25,88 €
B-58279	10	1000	940	60,29 €
B-58285	11	160	110	7,67 €
B-58291	11	210	160	9,27 €
B-58300	11	260	210	10,93 €
B-58316	11	310	260	14,59 €
B-58322	12	160	110	7,34 €
B-58338	12	210	160	8,94 €
B-58344	12	260	210	10,15 €

objednávacie číslo	ø (mm)	celková dĺžka (mm)	pracovná dĺžka (mm)	cena s DPH
B-58350	12	310	260	13,94 €
B-58366	12	450	400	20,92 €
B-58372	12	600	550	26,70 €
B-58388	12	1000	950	63,97 €
B-58394	13	160	110	9,66 €
B-58403	13	210	160	16,16 €
B-58419	13	260	210	18,21 €
B-58425	13	310	260	19,49 €
B-58431	14	160	110	10,35 €
B-58447	14	210	160	13,87 €
B-58453	14	260	210	15,96 €
B-58469	14	310	260	17,20 €
B-58475	14	450	400	21,58 €
B-58481	14	600	550	28,98 €
B-58497	14	1000	950	65,77 €
B-58506	15	160	110	15,96 €
B-58512	15	210	160	17,92 €
B-58528	15	260	210	19,68 €
B-58534	15	450	400	26,47 €
B-58540	16	160	110	16,55 €
B-58556	16	210	160	18,54 €
B-58562	16	260	210	20,66 €
B-58578	16	310	260	22,03 €
B-58584	16	450	400	27,16 €
B-58590	16	600	550	35,45 €
B-58609	16	1000	950	74,97 €
B-58615	18	250	200	27,55 €
B-58621	18	450	400	31,33 €
B-58637	20	250	200	29,83 €
B-58659	20	450	400	35,90 €
B-58665	22	250	200	33,75 €
B-58687	22	450	400	44,10 €
B-58693	24	250	200	42,33 €
B-58702	24	450	400	48,24 €
B-58718	25	250	200	43,15 €
B-58724	25	450	400	55,49 €
B-58746	28	250	200	50,92 €
B-58752	28	450	400	65,31 €
B-58768	30	250	200	57,28 €
B-58774	30	450	400	68,41 €
B-58780	32	450	400	75,56 €



# Príklepové vrtáky SDS-plus

## SDS-Plus vrtáky NEMESIS – sady



Štvorbřitý vrták SDS Plus. Odolnejší proti opotrebovaniu.

Rýchle a presné vrtanie. Optimálne vrtanie cez armatúru.

Štyri kanálky na odvod prachu.



objednávacie číslo	ø (mm)	celková dĺžka (mm)	pracovná dĺžka (mm)	ks/bal	cena s DPH
B-58986	5	110	50	1	16,19 €
	6	110	50	1	
	8	110	50	1	
B-59075	6	160	100	1	20,75 €
	8	160	100	1	
	10	160	100	1	
B-58992	5	110	50	1	30,82 €
	6	110	50	1	
	6	160	100	1	
	8	160	100	1	
B-59025	5	160	100	1	75,25 €
	6	160	100	3	
	8	160	100	3	
	10	160	100	3	
	12	160	100	2	
B-59031	5	110	50	1	49,10 €
	6	110	50	1	
	8	110	50	1	
	6	160	100	1	
	8	160	100	1	
	10	160	100	1	

objednávacie číslo	ø (mm)	celková dĺžka (mm)	pracovná dĺžka (mm)	ks/bal	cena s DPH
B-58827	6	160	100	5	25,48 €
B-58899	8	160	100	5	29,11 €
B-58914	10	160	100	5	32,18 €

objednávacie číslo	ø (mm)	celková dĺžka (mm)	pracovná dĺžka (mm)	ks/bal	cena s DPH
B-12550	8	160	100	25	143,97 €
B-12566	10	160	100	25	159,46 €

# Príklepové vrtáky SDS-plus

## Vrtáky 4brit SDS+

\*\*\*\*\*



objednávacie číslo	ø (mm)	celková dĺžka (mm)	pracovná dĺžka (mm)	cena s DPH
B-62496	6	110	50	2,71 €
B-62505	6	160	100	2,74 €
B-62511	6	210	150	3,00 €
B-62527	6	260	200	3,53 €
B-62614	8	160	100	3,49 €
B-62620	8	210	150	4,08 €
B-62636	8	260	200	4,48 €
B-62642	8	310	250	4,73 €
B-62658	8	460	400	7,54 €
B-62670	10	160	100	4,31 €
B-62686	10	210	150	4,73 €
B-62692	10	260	200	5,48 €
B-62701	10	310	250	8,65 €
B-62717	10	350	290	5,92 €
B-62723	10	460	400	8,65 €
B-62745	12	210	150	6,50 €
B-62751	12	260	200	7,12 €
B-62789	12	460	400	10,42 €

## Príklepové vrtáky SDS-plus s odsávaním

\*\*\*\*\*

objednávacie číslo	ø (mm)	celková dĺžka (mm)	pracovná dĺžka (mm)	cena s DPH
B-64381	12	325	200	70,34 €
B-64397	14	360	240	73,93 €
B-64406	16	360	240	77,85 €
B-64412	18	360	240	92,80 €







# Príklepové vrtáky SDS-plus

## Príklepové vrtáky SDS-Plus V Plus



Ideálne vrtáky na vítanie s príklepom do betónu, muriva a prírodného kameňa. Moderné tepelné spracovanie a špeciálna technológia kalenia povrchu znižujú opotrebovanie a zaručujú vysokú húževnatosť a odolnosť vrtákov voči namáhaniu ohybom. Vhodné pre vrtacie kladivá triedy 2–4 kg.

objednávacie číslo	ø (mm)	celková dĺžka (mm)	pracovná dĺžka (mm)	cena s DPH
B-47232	4	110	50	3,21 €
B-47248	4	160	100	3,97 €
B-46492	5	110	50	2,57 €
B-46501	5	160	100	3,08 €
B-47260	5	210	150	4,86 €
B-47276	5	260	200	6,53 €
B-47282	5	310	250	6,36 €
B-47298	5,5	110	50	2,80 €
B-47307	5,5	160	100	3,63 €
B-47313	5,5	210	150	4,75 €
B-47329	5,5	260	200	5,88 €
B-47335	5,5	310	250	9,37 €
B-46517	6	110	50	2,57 €
B-46523	6	160	100	2,77 €
B-47341	6	210	150	4,14 €
B-47357	6	260	200	5,23 €
B-47363	6	310	250	8,79 €
B-47379	6	460	400	12,83 €
B-47385	6,5	110	50	3,04 €
B-47391	6,5	160	100	3,69 €
B-47400	6,5	210	150	4,86 €
B-47416	6,5	260	200	6,50 €
B-47422	6,5	310	250	9,34 €
B-47438	7	110	50	2,98 €
B-47444	7	160	100	3,25 €
B-47450	7	210	150	4,92 €
B-47466	7	250	190	6,60 €
B-46539	8	110	50	2,98 €
B-46545	8	160	100	3,25 €
B-47472	8	210	150	4,31 €
B-47488	8	260	200	5,40 €
B-47494	8	310	250	7,01 €
B-47503	8	400	340	10,43 €
B-47519	8	460	400	11,05 €
B-47525	8	600	540	15,73 €
B-47531	9	160	100	4,07 €

objednávacie číslo	ø (mm)	celková dĺžka (mm)	pracovná dĺžka (mm)	cena s DPH
B-47547	9	210	150	5,44 €
B-47553	9,5	160	100	4,45 €
B-46551	10	110	50	3,56 €
B-46567	10	160	100	3,80 €
B-47569	10	210	150	5,13 €
B-47575	10	260	200	6,05 €
B-47581	10	310	250	7,01 €
B-47597	10	350	290	9,58 €
B-47606	10	450	390	11,66 €
B-47612	10	600	540	15,97 €
B-47628	10	800	740	24,28 €
B-47634	10	1000	940	40,70 €
B-47640	11	160	110	5,40 €
B-47656	11	210	160	6,26 €
B-47662	11	260	210	7,42 €
B-47678	11	310	260	9,17 €
B-46573	12	160	110	4,62 €
B-47684	12	210	160	5,71 €
B-47690	12	260	210	7,15 €
B-47709	12	310	260	9,10 €
B-47715	12	360	310	10,50 €
B-47721	12	450	400	12,69 €
B-47737	12	600	550	16,96 €
B-47743	12	800	750	26,27 €
B-47759	12	1000	950	44,02 €
B-47765	13	160	110	5,88 €
B-47771	13	210	160	6,77 €
B-47787	13	260	210	8,00 €
B-47793	13	310	260	10,02 €
B-46589	14	160	110	6,33 €
B-47802	14	210	160	7,22 €
B-47818	14	260	210	8,82 €
B-47824	14	310	260	9,88 €
B-47830	14	450	400	13,47 €
B-47846	14	600	550	18,43 €
B-47852	14	1000	950	45,01 €



# Príklepové vrtáky SDS-plus

## Príklepové vrtáky SDS-Plus V Plus



Ideálne vrtáky na vrtanie s príklepom do betónu, muriva a prírodného kameňa. Moderné tepelné spracovanie a špeciálna technológia kalenia povrchu znižujú opotrebovanie a zaručujú vysokú húževnatosť a odolnosť vrtákov voči namáhaniu ohybom. Vhodné pre vrtacie kladivá triedy 2–4 kg.



objednávacie číslo	ø (mm)	celková dĺžka (mm)	pracovná dĺžka (mm)	cena s DPH
B-47868	15	160	110	8,07 €
B-47874	15	210	160	9,47 €
B-47880	15	260	210	10,47 €
B-47896	15	450	400	16,14 €
B-47905	16	160	110	7,87 €
B-47911	16	210	160	9,37 €
B-47927	16	260	210	10,98 €
B-47933	16	310	260	12,18 €
B-47949	16	450	400	17,68 €
B-47955	16	600	550	22,26 €
B-47961	16	800	750	33,28 €
B-47977	16	1000	950	51,27 €
B-47983	17	210	160	14,54 €
B-47999	17	450	400	28,63 €
B-48000	18	200	150	15,56 €
B-48016	18	300	250	17,85 €
B-48022	18	450	400	22,67 €
B-48038	18	600	550	31,05 €
B-48044	18	1000	950	57,59 €
B-48050	19	200	150	17,99 €
B-48066	19	450	400	26,92 €

objednávacie číslo	ø (mm)	celková dĺžka (mm)	pracovná dĺžka (mm)	cena s DPH
B-48072	20	200	150	18,19 €
B-48088	20	300	250	20,25 €
B-48094	20	450	400	26,51 €
B-48103	20	600	550	34,99 €
B-48119	20	800	750	60,47 €
B-48125	20	1000	950	65,42 €
B-48131	22	250	200	24,62 €
B-48147	22	450	400	34,10 €
B-48153	22	600	550	43,91 €
B-48169	22	1000	950	70,08 €
B-48175	23	250	200	32,18 €
B-48197	24	250	200	30,78 €
B-48206	24	450	400	37,18 €
B-48212	24	600	550	44,08 €
B-48228	25	250	200	33,65 €
B-48234	25	450	400	40,32 €
B-48240	25	600	550	58,45 €
B-48256	25	1000	950	84,99 €
B-48262	26	250	200	34,06 €
B-48278	26	450	400	41,55 €

## Sada vrtákov SDS-plus



objednávacie číslo	popis	cena s DPH
B-49046	sada vtákov SDS-plus 5×110; 6×110; 6×160 8×110; 8×160; 10×160 12×160	30,32 €

## Vrtáky do ľadu SDS-plus



objednávacie číslo	popis	cena s DPH
821700-1	ø 32 mm × 450 mm	101,01 €



# Príklepové vrtáky SDS-plus

## Príklepové vrtáky SDS-Plus V Plus – sady



Ideálne vrtáky na vrtanie s príklepom do betónu, muriva a prírodného kameňa.

Moderné tepelné spracovanie a špeciálna technológia kalenia povrchu znižujú opotrebovanie a zaručujú vysokú húževnatosť a odolnosť vrtákov voči namáhaniu ohybom.

Vhodné pre víťacie kladivá triedy 2–4 kg.



objednávacie číslo	ø (mm)	celková dĺžka (mm)	pracovná dĺžka (mm)	ks/bal.	cena s DPH
B-46492-5	5	110	50	5	11,83 €
B-47298-5	5.5	110	50	5	13,02 €
B-46517-5	6	110	50	5	11,83 €
B-46523-5	6	160	100	5	12,85 €
B-47341-5	6	210	150	5	19,69 €
B-46539-5	8	110	50	5	13,88 €
B-46545-5	8	160	100	5	15,25 €
B-47472-5	8	210	150	5	20,55 €
B-46567-5	10	160	100	5	17,98 €
B-47569-5	10	210	150	5	24,65 €
B-46573-5	12	160	110	5	22,09 €
B-47684-5	12	210	160	5	27,56 €





# Príklepové vrtáky SDS-plus

## Príklepové vrtáky SDS-Plus V Plus – sady



Ideálne vrtáky na vrtanie s príklepom do betónu, muríva a prírodného kameňa.

Moderné tepelné spracovanie a špeciálna technológia kalenia povrchu znižujú opotrebovanie a zaručujú vysokú húževnatosť a odolnosť vrtákov voči namáhaniu ohybom.

Vhodné pre vrtacie kladivá triedy 2–4 kg.



objednávacie číslo	ø (mm)	celková dĺžka (mm)	pracovná dĺžka (mm)	ks/bal.	cena s DPH
B-47232-10	4	110	50	10	30,15 €
B-47248-10	4	160	100	10	37,67 €
B-46492-10	5	110	50	10	23,65 €
B-46501-10	5	160	100	10	28,78 €
B-47260-10	5	210	150	10	46,56 €
B-47282-10	5	310	250	10	61,61 €
B-47298-10	5.5	110	50	10	26,04 €
B-47307-10	5.5	160	100	10	34,25 €
B-47313-10	5.5	210	150	10	45,54 €
B-47329-10	5.5	260	200	10	56,82 €
B-46517-10	6	110	50	10	23,65 €
B-46523-10	6	160	100	10	25,70 €
B-47341-10	6	210	150	10	39,38 €
B-47357-10	6	260	200	10	50,33 €
B-47385-10	6.5	110	50	10	28,44 €
B-47391-10	6.5	160	100	10	34,94 €
B-47400-10	6.5	210	150	10	46,56 €
B-47416-10	6.5	260	200	10	62,98 €
B-47422-10	6.5	310	250	10	91,37 €
B-46539-10	8	110	50	10	27,75 €
B-46545-10	8	160	100	10	30,49 €
B-47472-10	8	210	150	10	41,09 €
B-47488-10	8	260	200	10	52,04 €
B-47494-10	8	310	250	10	68,11 €
B-47531-10	9	160	100	10	38,70 €
B-47547-10	9	210	150	10	52,38 €
B-47553-10	9.5	160	100	10	42,46 €
B-46551-10	10	110	50	10	33,57 €
B-46567-10	10	160	100	10	35,96 €
B-47569-10	10	210	150	10	49,30 €
B-47575-10	10	260	200	10	58,53 €
B-47581-10	10	310	250	10	68,11 €
B-47640-10	11	160	110	10	52,04 €
B-47656-10	11	210	160	10	60,59 €
B-47662-10	11	260	210	10	72,21 €
B-47678-10	11	310	260	10	89,66 €
B-46573-10	12	160	110	10	44,17 €
B-47684-10	12	210	160	10	55,11 €
B-47690-10	12	260	210	10	69,48 €
B-47709-10	12	310	260	10	88,97 €



# Príklepové vrtáky SDS-plus

## Príklepové vrtáky SDS-Plus V Plus – sady



Ideálne vrtáky na vrtanie s príklepom do betónu, muriva a prírodného kameňa.

Moderné tepelné spracovanie a špeciálna technológia kalenia povrchu znižujú opotrebovanie a zaručujú vysokú húževnatosť a odolnosť vrtákov voči namáhaniu ohybom.

Vhodné pre vrtacie kladivá triedy 2–4 kg.



objednávacie číslo	ø (mm)	celková dĺžka (mm)	pracovná dĺžka (mm)	ks/bal	cena s DPH
B-47232-25	4	110	50	25	74,37 €
B-47248-25	4	160	100	25	93,18 €
B-46492-25	5	110	50	25	58,13 €
B-46501-25	5	160	100	25	70,95 €
B-47260-25	5	210	150	25	115,41 €
B-47298-25	5.5	110	50	25	64,11 €
B-47307-25	5.5	160	100	25	84,63 €
B-47313-25	5.5	210	150	25	112,85 €
B-47329-25	5.5	260	200	25	141,06 €
B-46517-25	6	110	50	25	58,13 €
B-46523-25	6	160	100	25	63,26 €
B-47341-25	6	210	150	25	97,46 €
B-47357-25	6	260	200	25	124,82 €
B-47385-25	6.5	110	50	25	70,10 €
B-47391-25	6.5	160	100	25	86,34 €
B-47400-25	6.5	210	150	25	115,41 €
B-47416-25	6.5	260	200	25	156,45 €
B-46539-25	8	110	50	25	68,39 €
B-46545-25	8	160	100	25	75,23 €
B-47472-25	8	210	150	25	101,73 €
B-47488-25	8	260	200	25	129,09 €
B-47494-25	8	310	250	25	169,28 €
B-47531-25	9	160	100	25	95,75 €
B-47547-25	9	210	150	25	129,95 €
B-46551-25	10	110	50	25	82,92 €
B-46567-25	10	160	100	25	88,91 €
B-47569-25	10	210	150	25	122,25 €
B-47575-25	10	260	200	25	145,34 €
B-47640-25	11	160	110	25	129,09 €
B-47656-25	11	210	160	25	150,47 €
B-47662-25	11	260	210	25	179,54 €
B-46573-25	12	160	110	25	109,43 €
B-47684-25	12	210	160	25	136,79 €
B-47690-25	12	260	210	25	172,70 €



# Príklepové vrtáky SDS-plus

## Príklepové vrtáky SDS-Plus V Plus – sady



Ideálne vrtáky na vrtanie s príklepom do betónu, muriva a prírodného kameňa.

Moderné tepelné spracovanie a špeciálna technológia kalenia povrchu znižujú opotrebovanie a zaručujú vysokú húževnatosť a odolnosť vrtákov voči namáhaniu ohybom.

Vhodné pre vrtacie kladivá triedy 2–4 kg.



objednávacie číslo	ø (mm)	celková dĺžka (mm)	pracovná dĺžka (mm)	ks/bal	cena s DPH
B-47232-50	4	110	50	50	147,10 €
B-47248-50	4	160	100	50	185,10 €
B-46492-50	5	110	50	50	115,10 €
B-46501-50	5	160	100	50	140,80 €
B-47298-50	5.5	110	50	50	127,00 €
B-47307-50	5.5	160	100	50	168,50 €
B-46517-50	6	110	50	50	115,80 €
B-46523-50	6	160	100	50	131,50 €
B-47341-50	6	210	150	50	194,00 €
B-47357-50	6	260	200	50	248,00 €
B-47391-50	6.5	160	100	50	177,90 €
B-47444-50	7	160	100	50	158,45 €
B-46539-50	8	110	50	50	135,90 €
B-46545-50	8	160	100	50	149,90 €
B-47472-50	8	210	150	50	202,90 €
B-46551-50	10	110	50	50	164,90 €
B-46567-50	10	160	100	50	176,90 €
B-47569-50	10	210	150	50	243,90 €
B-47575-50	10	260	200	50	289,00 €
B-46573-50	12	160	110	50	217,90 €
B-47684-50	12	210	160	50	271,90 €



# Príklepové vrtáky SDS-plus

## Príklepové vrtáky SDS-Plus V Plus – sady



Ideálne vrtáky na vrtanie s príklepom do betónu, muriva a prírodného kameňa.  
 Moderné tepelné spracovanie a špeciálna technológia kalenia povrchu znižujú opotrebovanie a zaručujú vysokú húževnatosť a odolnosť vrtákov voči namáhaniu ohybom.  
 Vhodné pre vrtacie kladivá triedy 2–4 kg.



objednávacie číslo	celková dĺžka (mm)	ks/bal.	cena s DPH
B-49052	5x110	1 ks	14,12 €
	6x110	1 ks	
	8x110	1 ks	
	6x160	1 ks	
B-49068	8x160	1 ks	24,32 €
	5x110	1 ks	
	6x110	1 ks	
	8x110	1 ks	
	6x160	1 ks	
B-49074	8x160	1 ks	17,06 €
	10x160	1 ks	
	12x160	1 ks	
	5x110	1 ks	
B-49080	6x160	2 ks	46,73 €
	8x160	3 ks	
	10x160	2 ks	
	12x160	2 ks	
	14x160	1 ks	
B-49096	16x160	1 ks	35,77 €
	5x110	3 ks	
	6x160	4 ks	
	8x160	2 ks	
B-49105	10x160	2 ks	39,96 €
	12x160	2 ks	
	6x160	3 ks	
B-49127	8x160	4 ks	35,97 €
	10x160	3 ks	
	12x160	2 ks	
	5x110	1 ks	
	6x110	1 ks	
B-49133	6x160	2 ks	13,83 €
	8x160	2 ks	
	10x160	2 ks	
	10x210	1 ks	
B-49046	12x210	1 ks	30,32 €
	5x110	1 ks	
	6x110	1 ks	
	6x160	1 ks	
	8x110	1 ks	
	8x160	1 ks	
	10x160	1 ks	
12x160	1 ks		



# Príklepové vrtáky SDS-plus

## Príklepové vrtáky SDS-plus



Vhodné na vŕtanie s príklepom do betónu, muriva a prírodného kameňa.

Tieto robustné príklepové vrtáky SDS-plus sú cenovo výhodnou alternatívou vrtákov SDS-plus S4.

Sú optimálne pre príležitostné vŕtanie.



objednávacie číslo	ø (mm)	celková dĺžka (mm)	pracovná dĺžka (mm)	cena s DPH
D-16950	3,5	90	30	1,11 €
D-00016	4	110	50	1,23 €
D-00022	5	110	50	1,24 €
D-00038	5	160	100	1,22 €
D-00044	5,5	110	50	1,17 €
D-00050	6	110	50	1,18 €
D-00066	6	160	100	1,20 €
D-00072	6	210	150	1,44 €
D-00088	6,5	110	50	1,21 €
D-00094	6,5	160	100	1,21 €
D-00103	7	110	50	1,27 €
D-00119	7	160	100	1,16 €
D-00125	8	110	50	1,20 €
D-00131	8	160	100	1,27 €
D-00147	8	210	150	1,57 €
D-00153	8	260	200	1,82 €
D-00169	9	210	150	1,56 €
D-00175	10	160	100	1,32 €
D-00181	10	210	150	1,71 €
D-00197	10	260	200	1,85 €
D-00206	10	310	250	2,23 €
D-17538	10	460	400	4,53 €
D-00212	11	160	100	1,39 €
D-00228	12	160	100	1,56 €
D-00234	12	210	150	1,91 €
D-00240	12	260	200	2,07 €
D-16271	12	460	400	4,95 €
D-00256	13	160	100	1,59 €
D-00262	14	160	100	2,26 €

objednávacie číslo	ø (mm)	celková dĺžka (mm)	pracovná dĺžka (mm)	cena s DPH
D-00278	14	260	200	2,70 €
D-17544	14	460	400	5,13 €
D-00284	15	160	100	2,65 €
D-17550	15	460	400	5,66 €
D-00290	16	210	150	3,25 €
D-16287	16	460	400	6,07 €
D-00309	16	310	250	3,69 €
D-00315	17	210	150	3,66 €
D-00321	18	210	150	3,83 €
D-00337	18	300	240	4,84 €
D-17566	18	460	400	7,09 €
D-00343	19	210	150	4,40 €
D-16293	19	460	400	7,80 €
D-00359	20	210	150	4,80 €
D-00365	20	310	250	6,00 €
D-15235	20	460	400	8,19 €
D-00371	22	260	200	6,00 €
D-08062	22	310	250	6,81 €
D-15241	22	460	400	8,82 €
D-16302	24	460	400	9,69 €
D-00387	25	260	200	8,58 €
D-08517	25	310	250	8,29 €
D-15257	25	460	400	10,84 €
D-00393	26	260	200	8,37 €
D-08078	26	310	250	9,57 €
D-15263	26	460	400	12,82 €
D-16318	28	460	400	14,35 €
D-17572	30	460	400	19,01 €

## Príklepové vrtáky SDS-plus – sada



objednávacie číslo	ø (mm)	cena s DPH
D-00795	ø 5 × 110 mm ø 6 × 110 mm ø 8 × 110 mm ø 6 × 160 mm ø 8 × 160 mm	6,53 €





# Príklepové vrtáky SDS-plus

## Príklepové vrtáky SDS-plus



objednávacie číslo	ø (mm)	celková dĺžka (mm)	pracovná dĺžka (mm)	cena s DPH
D-66612	4	160	100	1,39 €
D-66628	5	210	150	1,72 €
D-66634	6,5	260	200	2,04 €
D-66640	8	310	250	2,58 €
D-66656	10	350	290	2,84 €
D-66662	11	210	150	2,10 €
D-66678	11	260	200	2,34 €
D-66684	12	310	250	2,75 €
D-66690	13	210	150	2,67 €
D-66709	14	310	250	3,52 €

# Príklepové vrtáky SDS-plus

## 12 dielna sada vrtákov SDS-Plus



objednávacie číslo	ø (mm)	cena s DPH
D-62723	3 ks Ø 6 mm × 160 mm 3 ks Ø 8 mm × 160 mm 3 ks Ø 10 mm × 160 mm 3 ks Ø 12 mm × 160 mm	15,82 €

## TCT drill bit & Chisel for SDS-PLUS Hammers 6pcs set



objednávacie číslo	ø (mm)	celková dĺžka (mm)	pracovná dĺžka (mm)	cena s DPH
D-58920	5, 6, 8 Bull Point 250 Cold Chisel 20x250 Scaling Chisel 40x250	160	100	16,38 €

## 5 dielna sada SDS Plus vrtákov



objednávacie číslo	ø (mm)	cena s DPH
D-61678	Ø 6 x 110 mm Ø 6 x 160 mm Ø 8 x 110 mm Ø 8 x 160 mm Ø 10 x 160 mm	6,40 €



# Príklepové vrtáky s valcovou stopkou



Vrtáky s valcovou stopkou sú určené pre vrtanie do betónu, muriva, a prírodného kameňa. Špeciálna špirála v tvare U zaručuje efektívny odvod odvítaných častíc a dlhú životnosť vrtáku.



objednávacie číslo	ø (mm)	celková dĺžka (mm)	cena s DPH
P-59592	3	60	0,69 €
P-59601	4	75	0,78 €
P-59617	5	85	0,89 €
P-59623	6	100	1,01 €
P-59754	6	200	2,25 €
P-59798	6	400	3,33 €
P-59891	6	600	7,34 €
P-59639	7	100	1,22 €
P-59645	8	120	1,35 €
P-59760	8	200	2,81 €
P-59807	8	400	4,15 €
P-59900	8	600	7,92 €
P-59651	9	120	1,51 €
P-59667	10	120	1,84 €
P-59776	10	200	3,38 €
P-59813	10	400	5,03 €
P-59916	10	600	8,85 €
P-59673	11	150	2,48 €
P-59689	12	150	2,79 €
P-59782	12	200	4,37 €
P-59829	12	400	6,20 €
P-59922	12	600	10,44 €

objednávacie číslo	ø (mm)	celková dĺžka (mm)	cena s DPH
P-59695	13	150	3,80 €
P-59704	14	150	4,10 €
P-59835	14	400	7,82 €
P-59938	14	600	15,83 €
P-59710	16	150	4,83 €
P-59841	16	400	9,66 €
P-59726	18	160	8,44 €
P-59857	18	400	11,55 €
P-59732	20	160	10,38 €
P-59863	20	400	14,04 €
P-59748	22	160	13,28 €
P-59975	22	600	33,39 €
P-59988	25	600	39,07 €

## Sada vrtákov do muriva



objednávacie číslo	ø (mm)	celková dĺžka (mm)	cena s DPH
P-34849	5,5; 6; 7; 8; 10	150	11,26 €



# Vrtáky do tehly s valcovou stopkou



Vrtáky s valcovou stopkou sú určené pre vrtanie do tehly. Špeciálna špirála v tvare U zaručuje efektívny odvod odvrátených častíc a dlhú životnosť vrtáku.



objednávacie číslo	ø (mm)	celková dĺžka (mm)	pracovná dĺžka (mm)	cena s DPH
D-40727	3	60	30	0,55 €
D-40733	3,5	75	40	0,55 €
D-40749	4	75	40	0,46 €
D-40755	4,5	85	50	0,39 €
D-40761	5	85	50	0,47 €
D-40777	5	150	90	0,75 €
D-40783	5,5	85	50	0,46 €
D-40808	6	100	60	0,65 €
D-40814	6	150	90	0,83 €
D-40820	6	200	130	1,17 €
D-40836	6	400	300	1,80 €
D-40842	6,5	100	60	0,59 €
D-40858	6,5	150	90	0,75 €
D-40864	6,5	400	300	2,28 €
D-40870	7	100	60	0,75 €
D-40886	7	150	90	0,82 €
D-40892	7	400	300	2,28 €
D-40901	8	120	80	0,81 €
D-40917	8	150	90	0,99 €
D-40923	8	200	130	1,43 €
D-40939	8	400	300	2,64 €
D-40945	9	120	80	0,82 €
D-40951	10	120	80	1,10 €
D-40967	10	150	90	1,29 €
D-40973	10	200	130	1,84 €
D-40989	10	400	300	2,87 €
D-41006	12	150	90	1,60 €
D-41012	12	200	130	2,31 €
D-41028	12	400	300	3,61 €

## Sada vrtákov do tehly



objednávacie číslo	ø (mm)	cena s DPH
P-23793	4; 5; 6; 8; 10	13,35 €



# Univerzálne vrtáky



Univerzálne vrtáky s valcovou stopkou určené na vrtanie do betónu, kachličiek, tehly, keramiky, dreva, plastu, hliníku a železa.



objednávacie číslo	ø (mm)	celková dĺžka (mm)	cena s DPH
D-30287	3	60	0,71 €
D-30293	4	70	0,76 €
D-30302	5	85	0,81 €
D-31027	5,5	85	0,67 €
D-31033	5,5	100	0,83 €
D-31049	5,5	150	0,67 €
D-30318	6	100	0,81 €
D-30324	6	150	0,80 €
D-31061	6,5	100	0,69 €
D-31077	6,5	150	0,85 €
D-30330	7	100	0,69 €
D-30346	7	150	0,86 €
D-30352	8	110	0,91 €
D-30368	8	150	0,87 €
D-30374	9	150	1,04 €
D-30380	10	150	1,66 €
D-30396	10	400	3,89 €
D-30411	12	150	1,82 €
D-30427	12	400	3,80 €
D-30433	12	600	4,85 €
D-30449	13	150	1,73 €
D-30455	14	150	1,94 €
D-30461	14	400	5,39 €

## Sada univerzálnych vrtákov



objednávacie číslo	ø (mm)	cena s DPH
P-23802	4; 5; 6; 8; 10	17,43 €





# Sekáče SDS-plus

## Sekacie nástroje SDS-plus so šesťhrannou stopkou



objednávacie číslo	opis	veľkosť (mm)	cena s DPH
P-05505	špicatý sekáč na najrôznejšie sekacie a asanačné práce v murive, betóne a uvoľnenom kameni	250	9,11 €
D-19015	špicatý sekáč na najrôznejšie sekacie a asanačné práce v murive, betóne a uvoľnenom kameni	400	3,75 €
P-05511	plochý sekáč na najrôznejšie sekacie a asanačné práce v murive, betóne a uvoľnenom kameni	20 × 250	9,11 €
D-19021	plochý sekáč na najrôznejšie sekacie a asanačné práce v murive, betóne a uvoľnenom kameni	20 × 400	3,83 €
P-05527	široký sekáč na univerzálny úber materiálu väčšieho rozsahu	40 × 200	13,55 €
P-05533	dutý sekáč na vysekávanie úzkych kanálov do betónu	22 × 250	14,92 €
B-14059	samoostriaci sekáč	40 × 250	14,55 €
122547-5	sekací nástavec (HR160D) umožňuje sekacie s vrtacími kladivami bez funkcie sekania (otáčavý pohyb sa zablokuje)		15,78 €

## Sekacie nástroje SDS-plus s valcovitou stopkou



objednávacie číslo	opis	veľkosť (mm)	cena s DPH
P-25068	špicatý sekáč na najrôznejšie sekacie a asanačné práce v murive, betóne a uvoľnenom kameni	250	6,27 €
P-25074	plochý sekáč na najrôznejšie sekacie a asanačné práce v murive, betóne a uvoľnenom kameni	20 × 200	6,27 €
A-30483		37 × 200	9,70 €
P-24935	široký sekáč na univerzálny úber materiálu väčšieho rozsahu	60 × 250	16,06 €
D-61020		80 × 250	16,91 €
P-24941		40 × 200	11,39 €
P-63987	široký zahnutý sekáč s ergonomicky zahnutou pracovnou časťou	40 × 260	16,00 €
P-24957		60 × 250	17,08 €
P-25080	dutý sekáč na vysekávanie úzkych kanálov do betónu	22 × 240	11,95 €
P-24963	krídelkový sekáč na sekacie do vápno-pieskových tehál, tehál a pemzy; ideálny na sekacie variabilných kanálov vďaka vodiacim krídelkám; na vysekávanie dier pre škatule svorkovnic a zásuviek bez výmeny nástroja	22 × 250	27,74 €
P-25105		20 × 170	18,32 €
P-25111	dláto na dlabanie do dreva	30 × 170	25,80 €
D-61020	sekáč	80 × 250	16,91 €



# Sekáče SDS-plus

## Sady vrtákov a sekáčov SDS-Plus



objednávacie číslo	ø (mm)	ks/bal	cena s DPH
D-21191	5,5 × 110 mm	1	46,43 €
	6 × 110 mm	1	
	7 × 160 mm	1	
	8 × 160 mm	1	
	10 × 210 mm	1	
	10 × 460 mm	1	
	16 × 460 mm	1	
	20 × 460 mm	1	
	sekáč špic 250 mm	1	
	sekáč plochý 250 × 20 mm	1	

objednávacie číslo	ø (mm)	ks/bal	cena s DPH
D-21200	5 × 110 mm	1	50,09 €
	5,5 × 110 mm	1	
	6 × 110 mm	1	
	6 × 160 mm	1	
	7 × 160 mm	1	
	8 × 110 mm	1	
	8 × 160 mm	1	
	8 × 210 mm	1	
	10 × 110 mm	1	
	10 × 160 mm	1	
	10 × 210 mm	1	
	14 × 260 mm	1	
	sekáč špic 140 mm	1	
	sekáč špic 250 mm	1	
	sekáč plochý 140 × 20 mm	1	
sekáč plochý 250 × 20 mm	1		
sekáč plochý 250 × 40 mm	1		

objednávacie číslo	ø (mm)	ks/bal	cena s DPH
D-16368	sekáč špic 250 mm	2	35,32 €
	sekáč plochý 250 × 20 mm	2	
	sekáč plochý 250 × 40 mm	1	



# Sekáče SDS-plus

## Sady vrtákov a sekáčov SDS-Plus



objednávacie číslo	ø (mm)	ks/bal	cena s DPH
D-19174	vrták 6 × 110 mm	1	49,72 €
	vrták 8 × 160 mm	1	
	vrták 10 × 210 mm	1	
	vrták 10 × 460 mm	1	
	vrták 12 × 210 mm	1	
	vrták 12 × 460 mm	1	
	vrták 16 × 460 mm	1	
	vrták 20 × 460 mm	1	
	sekáč špic 250 mm	1	
	sekáč plochý 20 × 250 mm	1	

objednávacie číslo	ø (mm)	ks/bal	cena s DPH
D-19180	vrták 5 × 110 mm	1	52,01 €
	vrták 6 × 110 mm	1	
	vrták 6 × 160 mm	1	
	vrták 8 × 110 mm	1	
	vrták 8 × 160 mm	1	
	vrták 8 × 210 mm	1	
	vrták 10 × 110 mm	1	
	vrták 10 × 160 mm	1	
	vrták 10 × 210 mm	1	
	vrták 12 × 160 mm	1	
	vrták 12 × 260 mm	1	
	vrták 14 × 160 mm	1	
	sekáč špic 140 mm	1	
	sekáč špic 250 mm	1	
	sekáč plochý 20 × 140 mm	1	
	sekáč plochý 20 × 250 mm	1	
	sekáč široký 40 × 250 mm	1	

objednávacie číslo	ø (mm)	ks/bal	cena s DPH
D-53073	ø 5 × 110 mm	1	45,82 €
	ø 5,5 × 110 mm	1	
	ø 6 × 110 mm	1	
	ø 6 × 160 mm	1	
	ø 7 × 160 mm	1	
	ø 8 × 110 mm	1	
	ø 8 × 160 mm	1	
	ø 8 × 210 mm	1	
	ø 10 × 110 mm	1	
	ø 10 × 160 mm	1	
	ø 10 × 210 mm	1	
	ø 14 × 260 mm	1	
	Sekáč špic 140 mm	1	
	Sekáč špic 250 mm	1	
	Sekáč plochý 20 × 140 mm	1	
	Sekáč plochý 20 × 250 mm	1	
	Sekáč široký 40 × 250 mm	1	



# Sekáče SDS-plus

## Sady vrtákov a sekáčov SDS-Plus



objednávacie číslo	ø (mm)	ks/bal	cena s DPH
D-20111	5 x 110 mm	1	36,30 €
	6 x 110 mm	1	
	6 x 160 mm	1	
	7 x 110 mm	1	
	7 x 160 mm	1	
	8 x 110 mm	1	
	8 x 160 mm	1	
	10 x 160 mm	1	
	12 x 160 mm	1	
	14 x 160 mm	1	
	16 x 160 mm	1	
		Sekáč špic 250 mm	
	Sekáč plochý 20 x 250 mm	1	

objednávacie číslo	ø (mm)	ks/bal	cena s DPH
D-58920	Ø 5 x 160 mm	1	16,38 €
	Ø 6 x 160 mm	1	
	Ø 8 x 160 mm	1	
	Sekáč špic 250 mm	1	
	Sekáč plochý 20 x 250 mm	1	
	Sekáč široký 40 x 250 mm	1	



# Vrtacie korunky SDS-plus

Špeciálne príslušenstvo pre vrtacie kladivá SDS-plus



objednávacie číslo	popis	cena s DPH
122573-4	adaptér skľučovadla SDS-plus / 1/2"-20 UNF	9,51 €
P-21646	Bitový adaptér 1/4"	8,93 €
P-39562	adaptér Bitro SDS-Plus/šesthnan 1/4" pre vrták 5 mm	9,47 €
P-38906	adaptér Bitro SDS-Plus/šesthnan 1/4" pre vrták 6 mm	7,54 €
P-38912	adaptér Bitro SDS-Plus/šesthnan 1/4" pre vrták 8 mm	7,90 €
P-38928	adaptér Bitro SDS-Plus/šesthnan 1/4" pre vrták 10 mm	8,23 €
194568-7	rýchlovýmenné skľučovadlo (vrtanie) HR3210FCT	93,23 €
194079-2	rýchlovýmenné skľučovadlo (vrtanie) HR2450T, HR2470T, HR2610T, HR2611FT, HR2810T, HR2811FT, BHR262T, DHR243, DHR264, HR2631FT, HR2630T	62,95 €
194080-7	rýchlovýmenné skľučovadlo (SDS-Plus) HR2450T, HR2470T, HR2610T, HR2611FT, HR2810T, HR2811FT, BHR261T, BHR262T, DHR243, DHR264, HR2631FT, HR2630T	31,62 €
194578-4	rýchlovýmenné skľučovadlo (SDS-Plus) HR3210FCT	76,58 €
192176-8	odsávacia súprava – ø 25 mm: pro HR2230	52,45 €
193472-7	odsávacia súprava – ø 25 mm: pro HR2470T, HR2810T a HR2811FT	48,61 €
421396-0	1) protiprachové tesnenie k odsávacej súprave Ø 25 mm	1,31 €
421384-7	2) protiprachová krytka k odsávacej súprave Ø 25 mm	1,67 €
122709-5	odsávacia súprava, kompletná pro HR2432	53,89 €
421664-1	protiprachový kryt pre stopku vrtáka a sekáča ø 10-18 mm	2,46 €
421342-3	ø 6-14 mm	1,49 €
195173-3	lapač prachu HR2600, HR2610, HR2611F	6,24 €
195180-6	lapač prachu HR2610T, HR2611FT	7,61 €
195547-8	adaptér na pripojenie lapača k hadici vysávača	1,97 €
P-08361	mazací tuk na prevodovku	3,00 €
198993-4	mazací tuk na nástroje	8,13 €
195195-3	servisná sada pre kladivá (HR4001C/HR4010C/HR4011C/HR4002) 2 ks – 181490-7 – vazelína; 1 ks – 194160-9 – uhlíky CB350; 1 ks – 286285-4 – kryt držiaku nástroja; 1 ks – 213317-4 – o-krúžok 20; 1 ks – 213392-0 – fluoridový o-krúžok 25; 1 ks – 213281-9 – X krúžok 18; 1 ks – 213962-5 – o-krúžok 22	20,64 €





# Vrtacie korunky SDS-plus

## Lahké vrtacie korunky UNICUT



Lahká konštrukcia týchto vrtacích korúnok výrazne rozširuje spektrum využitia vrtacích kladív SDS-plus. Hlavnou oblasťou ich využitia sú rôzne remeselnícke práce a práce v dome pri inštaláciách do muriva a moderných ľahkých stavebných hmôt.



\*korunka je dodávaná bez strediaceho vrtáka a upínacieho adaptéru

objednávacie číslo	ø (mm)	dĺžka (mm)	cena s DPH
P-64462	25	75	27,75 €
P-64484	35	75	33,26 €
P-64490	40	75	33,32 €
P-64509	45	75	35,03 €
P-64515	50	75	37,97 €
P-64521	55	75	38,85 €
P-64537	58	75	40,82 €
P-64543	60	75	42,52 €
P-64559	63	75	41,66 €
P-64565	65	75	42,48 €
P-64571	68	75	46,60 €
P-64587	70	75	53,54 €
P-64593	71	75	57,95 €
P-64602	74	75	55,18 €
P-64618	76	75	57,56 €
P-64624	78	75	56,19 €
P-64630	80	75	59,26 €
P-64646	85	75	63,72 €
P-64652	90	75	63,96 €
P-64668	105	75	86,56 €

## Príslušenstvo k vrtacím korunkám UNICUT



objednávacie číslo	popis	dĺžka	cena s DPH
P-64347	strediaci vrták 8 Ø	120	4,69 €
P-64319	adaptér SDS-Plus pre vrtáciu korunku 118 mm	118	28,82 €
P-64325	adaptér SDS-Plus pre vrtáciu korunku 220 mm	220	31,50 €
P-64331	adaptér SDS-Plus pre vrtáciu korunku 370 mm	370	35,96 €



### Kritériá kvality:

Kvôli geometrii rezania karbidových zubov vrtacej korunky nie je pre limity opotrebovania možné poskytnúť žiadne presné údaje. Trvanlivosť je v podstate určovaná materiálom, s ktorým sa pracuje. Rezačka otvorov bude plne funkčná až do prípadného odlomenia zuba alebo zaoblenia zubov.



Príznamy poškodenia: **Karbid poškodený, karbidové diely sú stále dostatočne prispájkované k základnému materiálu.**

Príčina: Nesprávne používanie nástroja

Záručná zodpovednosť: Neakceptovaná

Príznamy poškodenia: **Modré sfarbenie nástroja**

Príčina: Prehriatie nástroja počas nesprávneho používania

Záručná zodpovednosť: Neakceptovaná

# Vrtacie korunky SDS-plus

## Ľahké príklepové vrtacie korunky



Ľahká konštrukcia týchto vrtacích korúnok výrazne rozširuje spektrum využitia vrtacích kladív SDS-plus. Hlavnou oblasťou ich využitia sú rôzne remeselnícke práce a práce v dome pri inštaláciách do muriva a moderných ľahkých stavebných hmôt a betónu.



objednávacie číslo	popis	ø (mm)	cena s DPH
P-26191	ľahké vrtacie korunky m16	40	53,15 €
P-26200		50	56,62 €
P-26216		65	57,87 €
P-26222		80	66,36 €
P-64347	vystredovací vrták pre vrtacie korunky		4,69 €
P-67745	upínacia stopka pre vrtacie korunky		20,51 €

## Sada korúnok do dreva, sadrokartónu, plastu, sklolaminátu, MDF, mäkkého muriva



objednávacie číslo	obsah sady	cena s DPH
D-51297	Ø 22 mm	119,68 €
	Ø 35 mm	
	Ø 51 mm	
	Ø 57 mm	
	Ø 64 mm	
	Ø 76 mm	
	2 ks strediaci vrták upínací adaptér /šesthnan/	

## Sada korúnok



objednávacie číslo	obsah sady	cena s DPH
D-51281	Ø 22 mm	120,61 €
	Ø 25 mm	
	Ø 29 mm	
	Ø 35 mm	
	Ø 38 mm	
	Ø 45 mm	
	Ø 51 mm	
2 ks strediaci vrták upínací adaptér /šesthnan/		



# Príklepové vrtáky SDS-max

## Príklepové vrtáky ZENTRO MAX



Štvorbřitý vrták ZENTRO MAX sú dokonalou kombináciou nového inovatívneho tvaru hlavy vrtáku so špeciálnym tvarom špirály zaručujúcu nekompromisnú kvalitu v každom detaily. Tieto vrtáky sa vyznačujú veľmi dlhou životnosťou, veľkou presnosťou a ideálnym prenosom energie zo stroja na hrot vrtáku. Kvalitu týchto vrtákov ocenia hlavne majstri, ktorí potrebujú vŕtať do veľmi tvrdých materiálov – betónu, železobetónu alebo prírodného kameňa.

\*Priemery 12–15 mm sa dodávajú s dvomi ostriami.



objednávacie číslo	ø (mm)	celková dĺžka (mm)	pracovná dĺžka (mm)	cena s DPH
P-17033	12	*340	200	31,66 €
P-17049	12	*540	400	39,49 €
P-17055	12	*690	550	57,02 €
P-17077	14	*340	200	36,10 €
P-17083	14	*540	400	41,78 €
P-17108	15	*340	200	36,72 €
P-17114	15	*540	400	41,45 €
P-77730	16	340	200	37,41 €
P-77746	16	540	400	42,71 €
P-77752	16	920	800	63,49 €
P-77768	16	1320	1200	177,42 €
P-77774	18	340	200	38,92 €
P-77780	18	540	400	45,01 €
P-77796	18	920	800	66,86 €
P-77805	18	1320	1200	161,84 €
P-77811	20	320	200	40,70 €
P-77827	20	520	400	46,45 €
P-77833	20	920	800	71,62 €
P-77849	20	1320	1200	169,57 €
P-77855	22	320	200	44,11 €
P-77861	22	520	400	51,04 €
P-77877	22	920	800	77,89 €
P-77883	22	1320	1200	189,48 €
P-77899	24	320	200	50,07 €
P-77908	24	520	400	59,59 €
P-77914	25	320	200	51,82 €
P-77920	25	520	400	56,94 €
P-77936	25	920	800	90,80 €
P-77942	25	1320	1200	188,78 €
P-77958	26	520	400	63,93 €
P-77964	28	370	200	57,23 €
P-77970	28	570	450	64,95 €
P-77986	28	670	550	88,59 €
P-77992	28	920	800	105,07 €
P-78003	28	1320	1200	197,60 €
P-78019	30	370	250	60,84 €



# Príklepové vrtáky SDS-max

## Príklepové vrtáky ZENTRO MAX



Štvorbřitý vrták ZENTRO MAX sú dokonalou kombináciou nového inovatívneho tvaru hlavy vrtáku so špeciálnym tvarom špirály zaručujúcu nekompromisnú kvalitu v každom detaily. Tieto vrtáky sa vyznačujú veľmi dlhou životnosťou, veľkou presnosťou a id eálnym prenosom energie zo stroja na hrot vrtáku. Kvalitu týchto vrtákov ocenia hlavne majstri, ktorí potrebujú vŕtať do veľmi tvrdých materiálov – betónu, železobetónu alebo prírodného kameňa.



objednávacie číslo	ø (mm)	celková dĺžka (mm)	pracovná dĺžka (mm)	cena s DPH
P-78025	30	570	450	69,24 €
P-78031	32	370	250	63,87 €
P-78047	32	570	450	79,32 €
P-78053	32	920	800	122,49 €
P-78069	32	1320	1200	204,86 €
P-78075	35	370	250	78,17 €
P-78081	35	570	450	89,28 €
P-78097	35	670	550	111,54 €
P-78592	35	1320	1200	228,44 €
P-78106	37	370	250	98,77 €
P-78112	37	570	450	108,89 €
P-78128	37	920	800	155,70 €
P-78134	38	370	250	90,85 €
P-78140	38	570	450	112,34 €
P-78156	40	370	250	113,67 €
P-78162	40	570	450	136,11 €
P-78178	40	920	800	183,67 €
P-78184	40	1320	1200	245,48 €
P-78190	45	570	450	190,85 €
P-78209	45	920	800	234,31 €
P-78215	50	570	450	218,06 €
P-78221	52	570	450	238,21 €

## Príklepové vrtáky ZENTRO MAX



objednávacie číslo	popis	cena s DPH
P-17027	adaptér SDS-max na SDS-plus	76,18 €
122829-5	rýchlosklučovadlo s upínaním SDS-Max	65,58 €



# Príklepové vrtáky SDS-max

## Príklepové vrtáky s odsávaním SDS-max



objednávacie číslo	ø (mm)	celková dĺžka (mm)	pracovná dĺžka (mm)	cena s DPH
B-64428	16	600	400	161,18 €
B-64434	18	600	400	168,36 €
B-64440	20	600	400	171,26 €
B-64456	22	600	400	174,85 €
B-64462	24	600	400	180,37 €
B-64478	25	600	400	181,67 €
B-64484	28	600	400	203,51 €
B-64490	28	900	700	284,91 €
B-64509	30	600	400	210,66 €
B-64515	30	900	700	294,67 €
B-64521	32	600	400	220,09 €
B-64537	32	900	700	309,30 €
B-64543	35	600	400	226,62 €
B-64559	35	900	700	318,44 €





# Príklepové vrtáky SDS-max



Vrtáky sú cenovo výhodnou variantou a sú určené pre vrtanie do betónu, muriva a prírodného kameňa.



objednávacie číslo	ø (mm)	celková dĺžka (mm)	pracovná dĺžka (mm)	cena s DPH
D-33875	12	340	200	9,95 €
D-33881	12	540	400	15,84 €
D-33897	14	340	200	9,27 €
D-33906	14	540	400	15,91 €
D-33912	15	340	200	10,74 €
D-33928	15	540	400	15,35 €
D-33934	16	340	200	11,62 €
D-33940	16	540	400	16,77 €
D-33956	18	340	200	13,22 €
D-33962	18	540	400	16,82 €
D-33978	20	340	200	14,68 €
D-33984	20	540	400	18,84 €
D-33990	22	340	200	16,37 €
D-34001	22	540	400	21,46 €
D-34017	24	340	200	14,73 €
D-34023	24	540	400	22,83 €
D-34039	25	340	200	17,23 €
D-34045	25	540	400	22,41 €
D-34051	28	370	250	16,33 €
D-34067	28	570	450	29,45 €
D-34073	30	370	250	21,48 €
D-34089	30	570	450	39,07 €
D-34095	32	370	250	25,82 €
D-34104	32	570	450	43,25 €
D-34110	35	370	250	36,88 €
D-34126	35	570	450	48,48 €
D-34132	38	370	250	44,94 €
D-34148	38	570	450	56,43 €
D-34154	40	370	250	54,89 €
D-34160	40	570	450	65,08 €

# Príklepové vrtáky SDS-max



## Sady vrtákov SDS-Max

\*\*\*



objednávacie číslo	popis	cena s DPH
D-40587	16 × 340 mm 18 × 340 mm 20 × 340 mm	42,17 €

\*\*\*\*\*



objednávacie číslo	popis	cena s DPH
P-52445	20 × 520 mm 25 × 520 mm 32 × 570 mm 1 ks špicatý sekáč 400 mm 1 ks plochý sekáč 25 × 400 mm	230,45 €

\*\*\*\*\*



objednávacie číslo	popis	cena s DPH
P-77207	22 × 520 mm 32 × 570 mm 38 × 570 mm	245,90 €

\*\*\*\*\*



objednávacie číslo	popis	cena s DPH
P-77198	22 × 520 mm 25 × 520 mm 28 × 570 mm	172,57 €

# Štvorbrité vrtáky do príklepovej vrtačky

Kritériá kvality: Pri prvotnej analýze vrtáka je dôležité najprv stanoviť opotrebovanie drážky. K tomu sa zmeria najmenší priemer drážky ( $\varnothing d_2$ ) v rámci merania rozsahu (M2) a najväčší priemer ( $\varnothing d_1$ ) v rámci meracieho rozsahu (M1).

Meranie opotrebovania drážky: Na stanovenie, či bol dosiahnutý limit opotrebovania, sa použijú nasledujúce vzorce: Hodn. opotrebovania  $S = \varnothing d_1 - \varnothing d_2$

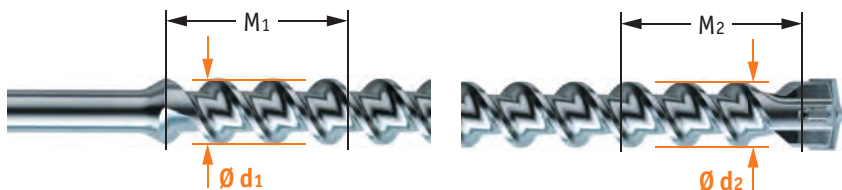

Vrták / Drill Bit $\varnothing$ (mm)	5 – 8	10 – 14	15 – 19	20 – 24	25 – 29	30 – 34	35 – 39	40 – 52
Hodn. opotr. / Wear value S (mm)	0,10	0,20	0,30	0,40	0,50	0,60	0,70	0,80
Vrták / Drill bit $\varnothing$ (inch)	$3/16 - 5/16$	$3/8 - 9/16$	$5/8 - 3/4$	$1 3/16 - 1 5/16$	$1 - 1 1/8$	$1 3/16 - 1 5/16$	$1 3/8 - 1 1/2$	$1 5/8 - 2$
Hodn. opotr. / Wear value S (inch)	0.004	0.008	0.012	0.016	0.020	0.024	0.028	0.031



#### Príznaky poškodenia:

Karbidová obla opotrebovaná drážka vo vodiacej časti vrtáka  
Príčina:  
Dosiahnutý limit opotrebovania uvedený v príslušnej tabuľke  
Záručná zodpovednosť:  
Neakceptovaná



#### Príznaky poškodenia:

Karbid poškodený, karbidové diely sú stále dostatočne prispájkované k základnému materiálu. Hlava vrtáka čiastočne zaoblená alebo poškodená  
Príčina:  
Nadmerné pnutie a vplyvy sily, napríklad vrtanie do výstuže  
Záručná zodpovednosť:  
Neakceptovaná



#### Príznaky poškodenia:

Karbid a základný materiál sú oddelené, na základnom materiáli nie sú viditeľné žiadne zvyšky karbidu  
Príčina:  
Chybné spájkovanie  
Záručná zodpovednosť:  
Akceptovaná



#### Príznaky poškodenia:

Hlava vrtáka odlomená tesne pod karbidovou špičkou  
Príčina:  
Trhlina vzniknutá napätím  
Záručná zodpovednosť:  
Akceptovaná



#### Príznaky poškodenia:

Karbid úplne chýba, na základnom materiáli nie sú viditeľné žiadne zvyšky karbidu  
Príčina:  
Chybné spájkovanie  
Záručná zodpovednosť:  
Akceptovaná



#### Príznaky poškodenia:

Časť drážky rovnomerne odlomená, uhol lomu je  $90^\circ$  k pozdĺžnej osi vrtáka  
Príčina:  
Trhlina vzniknutá napätím  
Záručná zodpovednosť:  
Akceptovaná



# Sekáče SDS-max

## Sekacie nástroje a príslušenstvo SDS-max



objednávacie číslo	popis	veľkosť (mm)	cena s DPH
P-16237	špicatý sekáč	280	8,26 €
P-16243	na najrôznejšie sekacie a asanačné práce v murive, betóne a uvoľnenom kameni	400	10,51 €
P-16259		600	16,61 €
P-16265	plochý sekáč	25 × 280	8,26 €
P-16271	na najrôznejšie sekacie a asanačné práce v murive, betóne a uvoľnenom kameni	25 × 400	10,51 €
P-16287		25 × 600	16,61 €
P-16302	široký sekáč na univerzálny úber materiálu väčšieho rozsahu	50 × 360	15,02 €
P-16318		80 × 300	22,75 €
P-16324	sekáč na kachličky vhodný na osekávanie kachličiek. ploché ostrie minimalizuje riziko vyštrbenia kachličiek	50 × 300	22,90 €
P-16293	dutý sekáč na vysekávanie úzkych kanálov do betónu	26 × 300	25,53 €
P-23721	lopatkový sekáč na všeobecné záhradnícke a poľnohospodárske práce, na kopanie v hline, zhutňovanie štrku a betónovej kaše, na veľkoplošné všeobecné cestárske práce	100 × 400	52,62 €
P-16330	kridelkový sekáč na sekacie do vápnopieskových tehál, tehál a pemzy; ideálny na sekacie variabilných kanálov vďaka vodiacim kridelkám; na vysekávanie dier pre škatule svorkovnic a zásuviek bez výmeny nástroja	35 × 380	50,04 €
P-16346	škárový sekáč na čistenie škár, vyberanie intaktných blokov muriva, odstraňovanie kachličiek alebo vrstiev omietky	38 × 280	70,96 €
P-03947	zrnovacia platnička (7×7 zubov) na zdršňovanie pri sanácii betónu a asfaltu	60 × 60	81,60 €
B-14015	samoostriaci sekáč	50 × 350	21,54 €
P-16352	upínacia stopka pre zrnovaciu platničku	250	29,36 €
P-18013	sada sekáčov SDS-max špicatý sekáč 280 mm špicatý sekáč 400 mm plochý sekáč 25 × 280 mm plochý sekáč 25 × 400 mm		89,77 €



# Sekáče SDS-max

## Sekacie nástroje a príslušenstvo SDS-max



	objednávacie číslo	popis	veľkosť (mm)	ks/bal.	cena s DPH
	D-34176	špicatý sekáč	300 × 18		5,97 €
	D-34182	na najrôznejšie sekacie a asanačné práce v murive, betóne a uvoľnenom kamení	400 × 18		7,03 €
	D-34198		600 × 18		9,76 €
	D-34207	plochý sekáč	300 × 25		5,96 €
	D-34213	na najrôznejšie sekacie a asanačné práce v murive, betóne a uvoľnenom kamení	400 × 25		6,86 €
	D-34229		600 × 25		9,74 €
	D-34235	široký sekáč na univerzálny úber	400 × 50		8,39 €
	D-34241	materiálu väčšieho rozsahu	300 × 80		13,40 €
	D-35324-10	SDS Max sekáč špic 400 mm	400	5	66,90 €
		SDS Max sekáč plochý 25 × 400 mm	25 × 400	5	

## Samoostriace sekáče



	objednávacie číslo	popis	cena s DPH
	B-10372	samoostriaci sekáč 28 mm šesťhran (HM1304B, HM1307 CB, HM1801, HM1810)	29,06 €
	B-10366	samoostriaci sekáč SDS MAX (HM0860C, HM1213C, HM0870C, HM0871C, HM1202C)	12,37 €
	B-10388	samoostriaci sekáč 30 mm šesťhran (HM1304, HM1400, HM1307C, HM1317C)	35,58 €
	B-23064	Samoostriaci sekáč SDS Max 400 mm	17,07 €

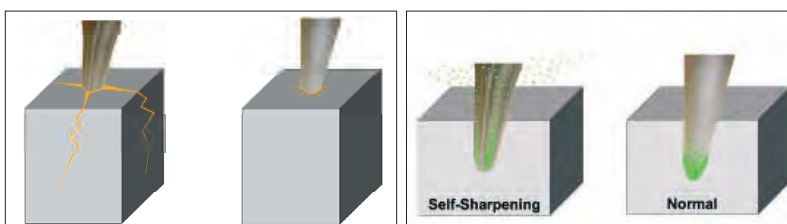
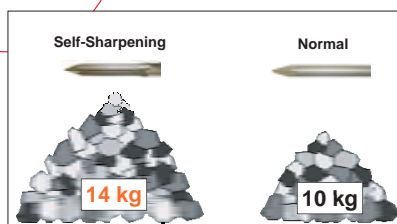
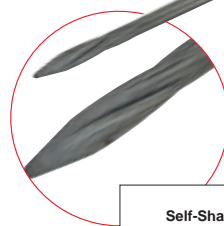



# Sekáče SDS-max

## Sady sekáčov



objednávacie číslo	popis	cena s DPH
D-40565	2ks Sekáč špic 400 mm 2ks Sekáč plochý 400x 25 mm 1ks Sekáč plochý 400x 50 mm 1ks Sekáč plochý 300x 80 mm	71,83 €
D-40618	3 ks špičatý sekáč 400 mm 2 ks plochý sekáč 400 × 25 mm	46,24 €
D-40571	Ø 18 × 540 mm Ø 20 × 540 mm Ø 22 × 540 mm Ø 25 × 540 mm 1 ks sekáč špic 400 mm 1 ks sekáč plochý 25 × 400 mm 1 ks sekáč plochý 50 × 400 mm	128,01 €
D-40543	1 ks sekáč špic 400 mm 1 ks sekáč plochý 25 × 400 mm 1 ks sekáč plochý 50 × 400 mm	44,64 €





# Vrtacie korunky SDS-max

## Príklepové vrtacie korunky



Vrtacie korunky Makita sú ideálne vhodné na vrtanie do betónu, muriva a prírodného kameňa.

Veniec vrtacej korunky je osadený symetricky usporiadanými, pevnými špeciálnymi zubami z tvrdého kovu.

Priamy prenos energie príklepu umožňuje dosahovať rýchly postup vrtania.

Účinná vonkajšia drážka v tvare špirály minimalizuje straty trením, umožňuje rýchly odsun odvítaného prachu a je zárukou dlhšej životnosti.

objednávacie číslo	popis	ø (mm)	cena s DPH	
P-73405	vrtacie korunky	35	91,65 €	
P-03779		40	90,47 €	
P-73411		45	100,99 €	
P-03785		50	107,48 €	
P-73427		60	112,45 €	
P-03791		65	116,10 €	
P-73433		68	119,59 €	
P-03800		80	131,21 €	
P-03816		90	164,21 €	
P-03822		100	184,39 €	
P-73449		110	211,89 €	
P-16374		125	245,12 €	
P-03838		vystredovaci vrták pre vrtacie korunky	11 × 120	8,08 €
P-16994		upínacia stopka pre vrtacie korunky	180	44,86 €
P-17005			450	64,63 €
P-03735	upínacia stopka šesťhran	450	58,31 €	
P-03763	vyrážací klin pre vrtacie korunky	140	7,68 €	

objednávacie číslo	popis	ø (mm)	celková dĺžka (mm)	cena s DPH
P-64397	vrtacie korunky SDS-max „jednodielne“  potrebné dokúpiť strediaci vrták P-03838	50	290	167,53 €
P-64406		68	290	193,09 €
P-64412		80	290	220,04 €
P-80204		90	550	282,06 €
P-25993		100	550	305,33 €
P-26004		125	550	359,42 €
P-26010		150	550	411,32 €

Hĺbka korunky 80 mm.



# Prerážacie vrtáky SDS-max

## Prerážacie vrtáky Makita do betónu



Výkonové parametre prerážacích vrtákov Makita do betónu:

- Rýchla montáž – nástroj je z jedného kusa
- Vyrvtanie celého priemeru – vylamovanie jadra nie je potrebné
- Jednodielna konštrukcia umožňuje prenos energie príklepu na špičku nástroja bez strát dôsledku útlmu
- Variabilná hĺbka vrtu podľa dĺžky stopky
- Rovná a okrúhla diera s plochým dnom
- Výrazne vyšší vrtací výkon ako s vrtacími korunkami



objednávacie číslo	popis	ø (mm)	cena s DPH
P-03844		40	145,91 €
P-14439		45	166,83 €
P-03850		50	166,99 €
P-04014	prerážacie vrtáky so závitovým čapom	55	196,61 €
P-04020		60	203,53 €
P-03866		68	221,97 €
P-03872		80	274,50 €
P-04036		90	381,08 €
P-03925		predĺženie Ratio pre prerážacie vrtáky	280
P-03888	upínacia stopka pre prerážacie vrtáky	185	59,91 €
P-03903	Upínacia stopka šesthran	160	47,62 €
P-03931	závitový čap	60	14,04 €



objednávacie číslo	ø (mm)	celková dĺžka (mm)	cena s DPH
B-57629	40	550	197,86 €
B-57635	45	550	202,85 €
B-57641	45	990	237,59 €
B-57657	55	550	226,83 €
B-57663	55	990	285,12 €
B-57679	65	550	250,53 €
B-57685	65	990	289,29 €
B-57691	80	550	274,70 €

## Prerážacie vrtáky

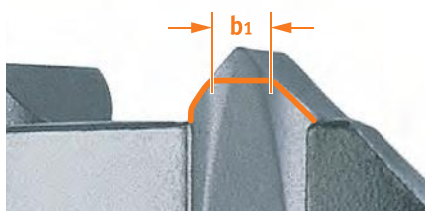

### Kritériá kvality:

Na stanovenie dosiahnutia limitu opotrebovania prerážacieho vrtáku je potrebné určiť opotrebovanie zuba v tvare dláta. K tomu musí byť zmeraná šírka ( $b_1$ ) na vrchu zuba, ktorá je závislá od opotrebovania. Ak je nameraná šírka  $\geq 1,8 \text{ mm} / 0.071 \text{ palca}$ , dláto dosiahlo svoj limit opotrebovania.



### Príznyky poškodenia

Zaoblená karbidová časť

Príčina:

Nad vyššie spomínaným limitom opotrebovania

Záručná zodpovednosť:

Neakceptovaná



### Príznyky poškodenia:

Karbid poškodený, karbidové diely sú stále dostatočne prispájkované k základnému materiálu

Príčina:

Nadmerné pnutie a vplyvy sily, napríklad vrtanie do výstuže

Záručná zodpovednosť:

Neakceptovaná



### Príznyky poškodenia:

Karbid úplne chýba, na základnom materiáli nie sú viditeľné žiadne zvyšky karbidu

Príčina:

Chybné spájkovanie

Záručná zodpovednosť:

Akceptovaná

## Vrtacie korunky

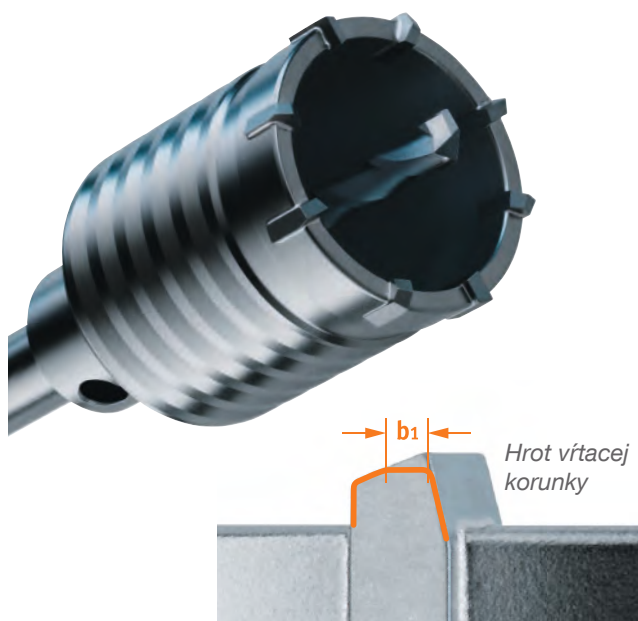

### Kritériá kvality:

Na stanovenie dosiahnutia limitu opotrebovania dutých sekáčov do príklepovej vrtacky je potrebné určiť opotrebovanie úderového zuba. Na to je potrebné zmerať šírku ( $b_1$ ) na vrchu zubov plochého sekáča, ktorá bola dosiahnutá opotrebovaním. Ak je nameraná šírka  $\geq 1,9$  mm/0.075 palcov, korunka dosiahla svoj limit opotrebovania.



### Príznyky poškodenia:

Zaoblená karbidová časť

Príčina:

Nad spomínaným limitom opotrebovania

Záručná zodpovednosť:

Neakceptovaná



### Príznyky poškodenia:

Karbid poškodený, karbidové diely sú stále dostatočne prispájkované k základnému materiálu.

Príčina:

Nadmerné pnutie a vplyvy sily, napríklad vrtanie do výstuže

Záručná zodpovednosť:

Neakceptovaná



### Príznyky poškodenia:

Karbid úplne chýba, na základnom materiáli nie sú viditeľné žiadne zvyšky karbidu

Príčina:

Chybné spájkovanie

Záručná zodpovednosť:

Akceptovaná

# System VERSIO

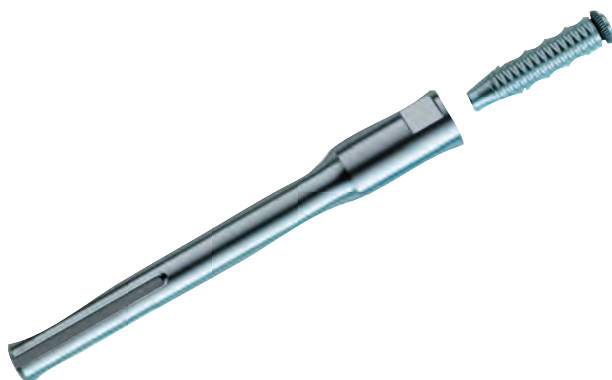
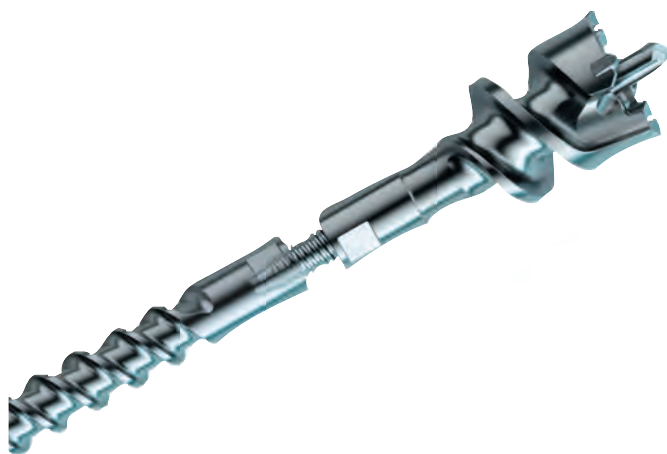

*Kritériá kvality:  
Prípady poškodenia systémov VERSIO  
nastanú väčšinou poškodením závitov.  
Aby sa zabránilo preťaženiu systému  
VERSIO, odporúčame tento systém  
len pre príklepové vŕtanie v kategórii  
do 8 kg.*



#### Príznaky poškodenia:

*Závitový nadstavec je nerovnomerne rozlomený*

*Príčina:*

*Rozlomenie preťažením, nadmerným ohýbaním a priečnym pnutím*

*Záručná zodpovednosť:*

*Neakceptovaná*

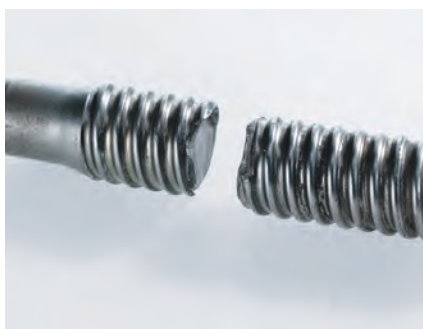

#### Príznaky poškodenia:

*Závitová časť nerovnomerne rozlomená*

*Príčina:*

*Rozlomenie preťažením, nadmerným ohýbaním a priečnym pnutím*

*Záručná zodpovednosť:*

*Neakceptovaná*



# Pre kladivá s upnutím tisíchrán

Príklepové vrtáky so 4 britmi



objednávacie číslo	ø (mm)	celková dĺžka (mm)	pracovná dĺžka (mm)	cena s DPH
P-03311	12*	380	250	42,72 €
P-03333	14*	380	250	44,68 €
P-03040	16	380	250	54,24 €
P-03056	16	530	400	53,74 €
P-03062	18	380	250	53,23 €
P-03078	19	380	250	53,85 €
P-03084	19	530	400	53,80 €
P-03090	19	700	570	86,13 €
P-03121	20	680	550	72,85 €
P-03143	22	530	400	63,42 €
P-03159	24	330	200	56,44 €
P-03165	24	530	400	68,76 €
P-03171	25	330	200	57,38 €
P-03193	28	380	250	70,19 €
P-03218	28	680	550	100,15 €
P-03224	30	380	250	81,73 €
P-03230	30	530	400	97,89 €
P-03246	32	380	250	76,34 €
P-03252	32	530	400	93,89 €
P-03268	35	380	250	84,88 €
P-03274	35	530	400	102,59 €
P-03280	35	680	550	144,43 €
P-03296	38	380	250	95,95 €
P-03305	38	530	400	124,16 €
P-03355	40*	330	200	125,05 €
P-03361	40*	570	450	147,44 €
P-03377	45*	370	250	142,51 €
P-03399	52*	920	800	259,04 €
P-03408	52*	370	250	282,04 €

\* dodávajú sa s 2 britmi



# Vrtanie do betónu

Dobré vrtáky sú dôležitou súčasťou každej skrinky s náradím. Nesprávny vrták môže zapríčiniť zlý výsledok vrtania alebo môže spôsobiť zničenie elektrického náradia, alebo iné škody. Makita ponúka kompletný sortiment vrtákov, aby ste mali k dispozícii vždy správny vrták pre vaše individuálne potreby. Od 1,5 mm vrtákov HSS po masívne 50 mm HM vrtáky s reznými hranami z tvrdého kovu na vrtanie do železobetónu. Všetky vrtáky sú k dispozícii so šesťhrannou stopkou 1/4", stopkou SDS-PLUS, SDS-MAX alebo v rovnom vyhotovení. Mnohé vrtáky sú vo vyhotovení tlmiacom vibrácie.

Spoločnosť Makita vyrába vysokokvalitné príslušenstvo, ktoré v kombinácii s profesionálnym elektrickým náradím predstavuje optimálne riešenie na každý prípad použitia.



## MAK4 SDS-MAX



Prémiový vrták SDS-MAX so štyrmi symetricky usporiadanými reznými hranami a centrovacím hrotom, na optimálne výsledky vrtania v železobetóne. Vďaka kónicky sa zbiehajúcim odvodným kanálom sa vrtná múčka plynulo odvádza do veľkoobjemovej špirály. Takto sa dosiahne vyššia rýchlosť vrtania pri podstatne vyššej životnosti. Vrtáky MAK4 garantujú vynikajúci pomer cena/výkon.



## Frézovacie korunky na betón SDS-MAX



Frézovacie korunky vyrobené z jedného kusa, ktoré boli vyvinuté pre poslednú generáciu vrtacích kladív. Rýchle a efektívne vrtanie v kombinácii s vynikajúcou životnosťou. Dostupné veľkosti: priemer do 80 mm a dĺžka do 900 mm. Nie je potrebný adaptér alebo dodatočný centrovací hrot.



## Duté vrtacie korunky SDS-MAX/-PLUS



Tento systém je vhodný na všetky typy vrtacích kladív. Adaptér je k dispozícii vo vyhotovení SDS-PLUS a SDS-MAX vo veľkostiach od 40–125 mm.

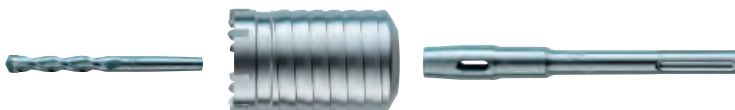

## Prílepové vrtáky SDS-PLUS (4-PLUS)



Široká paleta vrtákov s dvoma reznými hranami od 4 mm–30 mm. Prvá voľba pre domácich majstrov a na príležitostné použitie v profesionálnej oblasti. Cenovo výhodná alternatíva pre prípady, keď je požadovaný rýchly postup vo vrtaní.



## Prílepové vrtáky SDS-PLUS



Tieto vrtáky sú odolné voči vysokým teplotám, a preto sú obzvlášť vhodné na veľmi pevné materiály, ako je zelený betón alebo tehly. Tieto vrtáky vyvinuté pre domácich majstrov, ako aj pre profesionálov sa vyznačujú výborným pomerom cena/výkon s vynikajúcimi vrtnými vlastnosťami.



## Nemesis SDS-PLUS



Vrtáky Nemesis SDS+ vytvárajú menej vibrácií ako bežné vrtáky a zamedzujú tak zosilňovaniu vibrácií smerom k rukoväti. Unikátna hlava osadená reznými hranami z tvrdého kovu je koncipovaná na najtvrdšie materiály.





# Pre kladivá s upnutím tisíchrán



objednávacie číslo	popis	cena s DPH
192175-0	odsávacia sada ø 25 mm	52,00 €
421384-7	ochranná čiapočka proti prachu	1,67 €
421396-0	tesnenie proti prachu	1,31 €
192278-0	flexibilná hadica 1,5 m ø 25 mm	44,59 €
P-05424	ochranné misky proti prachu pre vrtáky/sekáče a upínacie stopky	94,13 €



# Pre kladivá s upnutím Kango

Príklepové vrtáky so 4 britmi



objednávacie číslo	ø (mm)	celková dĺžka (mm)	pracovná dĺžka (mm)	cena s DPH
P-03414	16	420	250	41,84 €
P-03420	16	570	400	57,29 €
P-03436	18	420	250	56,15 €
P-03442	18	570	400	58,15 €
P-03458	20	420	350	47,62 €
P-03464	20	570	400	60,07 €
P-03470	22	420	350	45,10 €
P-03486	22	570	400	63,44 €
P-03492	24	420	250	49,43 €
P-03501	24	570	400	64,38 €
P-03517	25	420	250	49,52 €
P-03539	25	720	550	76,59 €
P-03545	28	420	250	69,45 €
P-03551	28	570	400	75,79 €
P-03567	30	420	250	73,37 €
P-03573	30	570	400	87,58 €
P-03589	32	420	250	99,95 €
P-03604	32	420	250	110,06 €
P-03610	35	570	400	110,91 €
P-03626	38	420	250	107,19 €
P-03632	38	570	400	126,12 €
P-03648	40*	420	250	131,29 €
P-03654	40*	570	400	149,70 €
P-03660	44*	420	250	196,00 €
P-03676	44*	570	400	175,86 €
P-03682	50*	420	250	175,13 €
P-03698	50*	570	400	220,78 €

\* dodávajú sa s 2 britmi



# Pre kladivá s upnutím Kango

## Sekáče

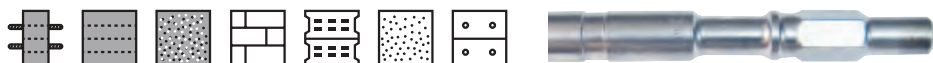

objednávacie číslo	popis	veľkosť (mm)	cena s DPH
P-13269	špicatý sekáč	600	28,48 €
P-13281	plochý sekáč	25 × 380	21,02 €
P-13312	široký sekáč	75 × 300	30,88 €
P-04210	adaptér 235 mm pre príklepové vrtáky s vojdrážkovou stopkou (typ Hilti) a SDS-plus		73,75 €
P-02319	adaptér 275 mm pre príklepové vrtáky Hilti TE52-92 a SDS-Max		157,15 €



# Pre kladivá s upnutím Bosch 19 mm

Sekáče pre Bosch kladivá 19 mm bez odsústruženého konca

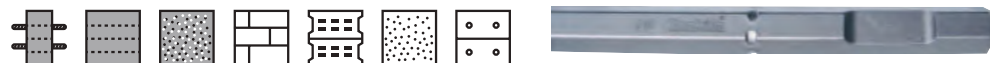

objednávacie číslo	popis	veľkosť (mm)	cena s DPH
P-05620	špicatý sekáč	400	16,56 €
P-05614		600	24,75 €
P-05636	plochý sekáč	25 × 400	16,98 €
P-05642		25 × 600	23,55 €
P-05686	široký sekáč	60 × 450	35,67 €
P-05658	drážkovací sekáč	22 × 300	24,81 €
P-05670	rýľový sekáč	140 × 350	66,76 €
P-03947	zdrsňovacia doska 7 × 7 zúbkov	60 × 60	81,60 €
P-03953	uchytenie zdrsňovacej dosky	270	27,24 €



# Pre kladivá s upnutím Bosch 19 mm

Sekáče pre Bosch kladivá 19 mm s odsústruženým koncom

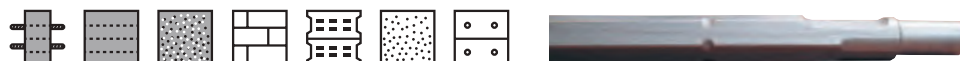

objednávacie číslo	popis	veľkosť (mm)	cena s DPH
P-13122	špicatý sekáč	300	16,57 €
P-13138		450	19,09 €
P-13144	plochý sekáč	26 × 300	16,67 €
P-13150		26 × 450	19,35 €
P-13166	široký sekáč	50 × 300	27,84 €
P-13188	drážkovací sekáč	22 × 250	24,23 €
P-13194		26 × 300	56,41 €
P-13172	rýľový sekáč	110 × 400	68,88 €
P-13219	sekáč na škáry	380	58,56 €
P-03947	zdrsňovacia doska 7 × 7 zubkov	60 × 60	81,60 €
P-03997	uchytenie zdrsňovacej dosky	200	41,83 €





# Pre kladivá s upnutím Bosch 28 mm

Sekacie nástroje pre HM1304B, HM1801, HM1810, HM1307CB, HM1317CB, HM1802/HM1812

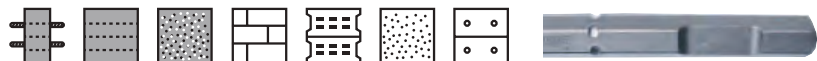

	objednávacie číslo	popis	veľkosť (mm)	cena s DPH
	P-05692	špicatý sekáč na najrôznejšie sekacie a asanačné práce v murive, betóne a uvoľnenom kameni	400	29,68 €
	D-65034	špicatý sekáč	28,6 x 350	18,28 €
	P-05723	plochý sekáč pre HM1801/HM1810 na najrôznejšie sekacie a asanačné práce v murive, betóne a uvoľnenom kameni	29 x 400	30,17 €
	P-05701	široký sekáč na univerzálny úber materiálu väčšieho rozsahu	80 x 400	55,19 €
	P-05717	lopatkový sekáč na všeobecné záhradnícke a poľnohospodárske práce, na kopanie v hline, zhutňovanie štrku a betónovej kaše, na cestárske práce	125 x 400	74,81 €
	197148-8	Odsávanie pre HM1802/1812		77,01 €

## Sekáč špic uchytenie šesťhran ø 28,6mm

	objednávacie číslo	popis	veľkosť (mm)	cena s DPH
	D-17631	špicatý sekáč na najrôznejšie sekacie a asanačné práce v murive, betóne a uvoľnenom kameni	410	22,14 €



objednávacie číslo	popis	cena s DPH
P-20052	prepravný vozík (HM1801/HM1810, HM1802/HM1812)	184,02 €
D-26294	prepravný vozík (HM1801/HM1810)	79,34 €



# Pre kladivá s upnutím šesťhran 13 mm

## Vrtáky so 4 britmi



objednávacie číslo	ø (mm)	celková dĺžka (mm)	pracovná dĺžka (mm)	cena s DPH
P-02783	16	280	130	32,65 €
P-02808	18	280	130	34,81 €
P-02820	19	280	130	39,90 €
P-02836	19	550	400	50,71 €
P-02842	20	280	130	41,57 €
P-02858	20	550	400	54,61 €
P-02864	22	280	130	42,98 €
P-02870	22	550	400	56,17 €
P-02886	22	905	755	102,59 €
P-02892	25	280	130	46,22 €
P-02901	25	550	400	80,70 €
P-02917	25	905	755	109,36 €
P-02923	28	280	130	53,66 €
P-02951	30	280	130	57,28 €
P-02973	32	280	130	67,19 €
P-02989	32	550	400	80,39 €
P-02995	35	280	130	66,51 €
P-03006	35	550	400	87,98 €
P-03012	35	905	755	153,64 €
P-03028	38	250	130	79,64 €
P-03034	38	550	400	97,78 €



# Upínacia stopka Makita

17 mm šesťhranná



objednávacie číslo	popis	veľkosť (mm)	cena s DPH
P-13035	špicatý sekáč	280	15,54 €
P-13041		450	19,30 €
P-13057	plochý sekáč	17 × 280	15,39 €
P-13063		17 × 450	19,69 €
P-13079	široký sekáč	45 × 280	19,91 €
P-13085	lopatkový sekáč	110 × 400	94,56 €
P-67393	dutý sekáč	22 × 280	29,73 €
P-13100	kridelkový sekáč	35 × 380	60,78 €
P-03947	zrnovacia platnička 7×7 zubov	60 × 60	81,60 €
798225-5	ubíjadlo s upínacou stopkou	ø 140	89,04 €



# Upínacia stopka Makita

19 mm šesťhranná



objednávacie číslo	popis	veľkosť (mm)	cena s DPH
P-13340	špicatý sekáč	220	14,68 €
P-13362	široký sekáč	50 × 150	23,59 €
B-07010		50 × 220	18,15 €
P-13845	dutý sekáč	8 × 170	21,73 €
798297-0		20 × 170	26,85 €
122431-4	škrabák	100 × 160	91,58 €
P-05474	sekáč na omietku	50 × 190	25,31 €
P-05480	sekáč na tmel	45 × 190	30,48 €
423154-0	ochranná čiapočka proti prachu		0,65 €



# Upínacia stopka Makita

21 mm šesťhranná

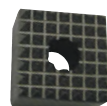

objednávacie číslo	popis	veľkosť (mm)	cena s DPH
P-13378		320	20,11 €
P-13384	špicatý sekáč	450	24,36 €
P-13390		600	22,52 €
P-13409		26 × 320	20,11 €
P-13415	plochý sekáč	26 × 450	24,36 €
P-13421		26 × 600	23,88 €
P-13437	široký sekáč	70 × 320	42,51 €
P-13443	lopatkový sekáč	100 × 450	38,44 €
P-03947	zrnovacia platnička 7×7 zubov	60 × 60	81,60 €
P-03975	upínacia stopka pre zrnovaciú platničku	200	47,38 €
798224-7	ubíjadlo s upínacou stopkou	ø 140	110,80 €



# Upínacia stopka Makita

30 mm šesťhranná upínacia stopka pre HM1304, HM1307C, HM1317C



	objednávacie číslo	popis	veľkosť (mm)	cena s DPH
	P-05549	špicatý sekáč	400	31,40 €
	P-05561	na najrôznejšie sekacie a asanačné práce v murive, betóne a uvoľnenom kameni	700	47,43 €
	P-05577		1000	80,24 €
	P-13487	plochý sekáč	32 × 400	31,89 €
	P-05583	na najrôznejšie sekacie a asanačné práce v murive, betóne a uvoľnenom kameni	32 × 700	49,06 €
	P-13518	široký sekáč	115 × 400	77,23 €
	P-05555	na univerzálny úber materiálu väčšieho rozsahu		
	P-05555	lopatkový sekáč	125 × 400	81,40 €
		na všeobecné záhradnícke a poľnohospodárske práce, na kopanie v hline, zhutňovanie štrku a betónovej kaše, na veľkoplošné cestárske práce		
	A-31485	ubíjadlo s upínacou stopkou	ø 200	128,08 €
	P-05446	na zhutňovanie pôdy, štrku, piesku a kameniva		
	P-05446	ochranná čiapočka proti prachu pre vrtáky, sekáče a upínacie stopky		4,13 €

30 mm šesťhranná upínacia stopka pre HM1400

	objednávacie číslo	popis	veľkosť (mm)	cena s DPH
	P-05549	špicatý sekáč	400	31,40 €
	P-05561	na najrôznejšie sekacie a asanačné práce v murive, betóne a uvoľnenom kameni	700	47,43 €
	P-05577		1000	80,24 €
	P-13502	plochý sekáč	32 × 400	32,07 €
		na najrôznejšie sekacie a asanačné práce v murive, betóne a uvoľnenom kameni		
	P-13493	široký sekáč	115 × 400	77,22 €
		na univerzálny úber materiálu väčšieho rozsahu		
	P-05608	lopatkový sekáč	125 × 400	85,13 €
		na všeobecné záhradnícke a poľnohospodárske práce, na kopanie v hline, zhutňovanie štrku a betónovej kaše, na veľkoplošné cestárske práce		
	A-31485	ubíjadlo s upínacou stopkou	ø 200	128,08 €
	P-05446	na zhutňovanie pôdy, štrku, piesku a kameniva		
	P-05446	ochranná čiapočka proti prachu pre vrtáky, sekáče a upínacie stopky		4,13 €





# Rukoväte

pre vŕtačky, vŕtacie a sekacie kladivá

objednávacie číslo	pre model	cena s DPH
134915-0	HR4500C	27,56 €
134945-1	HR5001C	28,72 €
134890-0	HR4500C, HR4511C, HM1101C, HM1111C	38,52 €
135269-8	HM1202C, HR5202C, HR5211C, HR5212C, HM1205C, HM1213C	42,89 €
135283-4	HM1214C	41,20 €

objednávacie číslo	pre model	cena s DPH
135302-6	HP1621, HP1630, HP1631, MT815, HP2051, HP2071, HR2440, HR2450, HR2470	2,85 €
134889-5	HR3000C, HM0860C	22,32 €
135197-7	HR3200C, HR3210FCT	22,12 €
135209-6	HR3541FC, HR4011C, HR4511C	21,87 €
134916-8	HR4500C	25,54 €
135332-7	HM0870C, HM0871C	17,90 €
135629-4	HR5211C, HR5202C, HR5212C	26,99 €





# Rukoväte

pre vŕtačky



objednávacie číslo	pre model	cena s DPH
134903-7	DP3003, DP4001	9,68 €
134910-0	DP47003	13,83 €

príslušenstvo pre vŕtačky, vŕtacie a sekacie kladivá



objednávacie číslo	popis	cena s DPH
765009-6	vyfukovací balónik po vŕtaní	2,22 €
443122-7	tkaná handrička	2,22 €

# Vrtáky do dreva s valcovitou stopkou

## Skrutkovicové vrtáky do dreva



objednávacie číslo	ks/bal.	ø (mm)	celková dĺžka (mm)	pracovná dĺžka (mm)	cena s DPH
D-07238	1	6	200	130	2,58 €
D-07244	1	8	200	130	2,69 €
D-07250	1	10	200	130	3,38 €
D-07266	1	12	200	130	3,53 €
D-07272	1	14	200	130	3,88 €
D-07288	1	16	200	130	4,21 €
D-07294	1	18	200	130	4,63 €
D-07303	1	20	200	130	5,37 €
D-07319	1	22	200	130	6,45 €
D-07325	1	24	200	130	7,08 €
D-07331	1	6	250	180	2,73 €
D-07347	1	8	250	180	3,15 €
D-07353	1	10	250	180	3,60 €
D-07369	1	12	250	180	3,76 €
D-07375	1	14	250	180	4,71 €
D-07381	1	16	250	180	4,65 €
D-07397	1	18	250	180	5,54 €
D-07406	1	20	250	180	5,95 €
D-07412	1	22	250	180	6,83 €
D-07428	1	24	250	180	8,32 €
D-07434	1	8	400	230	5,61 €
D-07440	1	10	400	230	6,12 €
D-07456	1	12	400	230	6,82 €
D-07462	1	14	400	230	7,49 €
D-07478	1	16	400	230	8,35 €
D-07484	1	18	400	230	10,61 €
D-07490	1	20	400	230	10,72 €
D-07509	1	22	400	230	12,59 €
D-07515	1	24	400	230	14,79 €
D-07521	1	26	400	230	16,36 €
D-07537	1	28	400	230	20,45 €
D-07543	1	30	400	230	23,30 €
D-07559	1	8	450	370	6,71 €
D-07565	1	10	450	370	7,57 €
D-07571	1	12	450	370	8,46 €
D-07587	1	14	450	370	8,71 €
D-07593	1	16	450	370	11,78 €
D-07602	1	18	450	370	12,87 €
D-07618	1	20	450	370	14,56 €
D-07624	1	22	450	370	16,09 €
D-07630	1	24	450	370	18,28 €
D-07646	1	26	450	370	20,00 €
D-07652	1	28	450	370	25,16 €
D-07668	1	30	450	370	27,95 €



# Vrtáky do dreva so šesťhrannou stopkou

## Skrutkovicové vrtáky do dreva



objednávacie číslo	ks/bal.	ø (mm)	celková dĺžka (mm)	cena s DPH
P-58067	1	4	200	4,18 €
P-58073	1	5	200	4,31 €
P-58089	1	6	200	5,12 €
P-58095	1	8	200	5,68 €
P-58213	1	8	300	7,96 €
P-58350	1	8	450	10,38 €
P-58497	1	8	600	11,67 €
P-58104	1	10	200	6,66 €
P-58229	1	10	300	8,52 €
P-58366	1	10	450	10,54 €
P-58506	1	10	600	12,31 €
P-58110	1	12	200	7,83 €
P-58235	1	12	300	10,05 €
P-58372	1	12	450	12,63 €
P-58512	1	12	600	14,59 €
P-58126	1	14	200	8,75 €
P-58241	1	14	300	12,57 €
P-58388	1	14	450	15,41 €
P-58528	1	14	600	17,72 €
P-58257	1	15	300	14,04 €
P-58394	1	15	450	17,30 €
P-58132	1	16	200	9,66 €
P-58263	1	16	300	14,49 €
P-58403	1	16	450	17,66 €
P-58534	1	16	600	20,01 €
P-58148	1	18	200	10,97 €
P-58279	1	18	300	16,91 €
P-58419	1	18	450	20,50 €
P-58540	1	18	600	24,61 €

objednávacie číslo	ks/bal.	ø (mm)	celková dĺžka (mm)	cena s DPH
P-58154	1	20	200	12,57 €
P-58285	1	20	300	18,70 €
P-58425	1	20	450	22,52 €
P-58556	1	20	600	27,32 €
P-58160	1	22	200	13,22 €
P-58291	1	22	300	20,47 €
P-58431	1	22	450	28,59 €
P-58562	1	22	600	29,36 €
P-58176	1	24	200	14,95 €
P-58300	1	24	300	22,26 €
P-58447	1	24	450	26,44 €
P-58578	1	24	600	31,63 €
P-58316	1	25	300	24,64 €
P-58453	1	25	450	32,87 €
P-58182	1	26	200	18,34 €
P-58322	1	26	300	26,47 €
P-58469	1	26	450	34,96 €
P-58584	1	26	600	40,83 €
P-58198	1	28	200	20,20 €
P-58338	1	28	300	29,85 €
P-58475	1	28	450	38,12 €
P-58590	1	28	600	42,61 €
P-58207	1	30	200	21,71 €
P-58344	1	30	300	32,97 €
P-58481	1	30	450	44,42 €
P-58609	1	30	600	50,17 €
P-58615	1	32	600	53,66 €
P-58621	1	34	600	68,81 €
P-58637	1	36	600	75,46 €



# Vrtáky do dreva

## Skrutkovicové vrtáky do dreva s 1/4" upínaním



objednávacie číslo	ø (mm)	celková dĺžka (mm)	pracovná dĺžka (mm)	cena s DPH
D-15992	6	200		3,47 €
D-16003	8	200		3,79 €
D-16019	10	200		4,38 €
D-16025	12	200		5,01 €
D-16031	14	200		5,18 €
D-16047	16	200		5,24 €
D-16053	18	200		6,19 €
D-16069	20	200		6,52 €
D-16075	21	200		6,87 €

## Sada vrtákov do dreva – upínanie 1/4"



objednávacie číslo	ø (mm)	cena s DPH
D-62371	2	5,61 €
	3	
	3	
	4	
	5	
	6	
	8	





# Vrtáky do dreva s valcovitou stopkou

## Špirálové vrtáky do dreva podľa DIN338



objednávacie číslo	ks/bal.	ø (mm)	celková dĺžka (mm)	cena s DPH
P-57473	1	3	60	0,43 €
P-57489	1	4	75	0,45 €
P-57495	1	5	85	0,54 €
P-57504	1	6	95	0,61 €
P-57510	1	7	110	0,67 €
P-57526	1	8	115	0,82 €
P-57532	1	9	125	0,93 €
P-57548	1	10	135	1,01 €
P-57554	1	12	155	1,47 €
P-57560	1	14	170	2,15 €
P-57576	1	16	180	2,89 €
P-57582	1	18	200	4,68 €
P-57598	1	20	200	5,45 €
P-57607	1	22	205	8,32 €
P-57613	1	24	215	10,28 €
P-57629	1	26	215	13,28 €
P-57635	1	28	220	16,68 €
P-57641	1	30	220	19,32 €
D-07157	1	6	315	2,77 €
D-07163	1	8	315	3,37 €
D-07179	1	10	315	3,61 €
D-07185	1	12	315	4,87 €
D-07191	1	14	315	5,59 €
D-07200	1	16	315	7,34 €
D-07216	1	18	315	9,09 €
D-07222	1	20	315	11,53 €

## 5 dielna sada špirálových vrtákov do dreva:



objednávacie číslo	ks/bal.	ø (mm)	celková dĺžka (mm)	cena s DPH
P-57657	1	4	75	3,85 €
	1	5	85	
	1	6	95	
	1	8	115	
	1	10	135	

## 7 dielna sada špirálových vrtákov do dreva:



objednávacie číslo	ks/bal.	ø (mm)	celková dĺžka (mm)	cena s DPH
P-57663	1	3	60	5,97 €
	1	4	75	
	1	5	85	
	1	6	95	
	1	7	110	
	1	8	115	
	1	10	135	



# Vrtáky do dreva s valcovou stopkou

## Vrtáky do dreva s dvomi ostriami a centrovacím hrotom



objednávacie číslo	ks/bal.	ø (mm)	celková dĺžka (mm)	cena s DPH
P-57679	1	6	315	2,22 €
P-57685	1	8	315	2,77 €
P-57691	1	10	315	3,52 €
P-57700	1	12	315	4,85 €
P-57716	1	14	315	5,63 €
P-57722	1	16	315	7,31 €
P-57744	1	20	335	10,44 €
P-57750	1	8	450	4,72 €
P-57766	1	10	450	6,04 €
P-57772	1	12	450	7,77 €
P-57794	1	16	450	11,00 €
P-57803	1	18	450	14,39 €
P-57819	1	20	450	17,53 €



## Vrtáky do dreva s dvomi ostriami a centrovacím hrotom



objednávacie číslo	ø (mm)	celková dĺžka (mm)	pracovná dĺžka (mm)	cena s DPH
D-07026	3	60	33	0,46 €
D-07032	4	75	43	0,47 €
D-07048	5	85	52	0,49 €
D-07054	6	95	57	0,52 €
D-07157	6	315	160	2,77 €
D-07060	7	110	69	0,65 €
D-07076	8	115	75	0,85 €
D-07163	8	315	160	3,37 €
D-07082	9	125	81	0,93 €
D-07179	10	315	160	3,61 €
D-07107	12	155	101	1,52 €
D-07185	12	315	160	4,87 €
D-07113	14	170	108	1,97 €
D-07191	14	315	160	5,59 €
D-07129	16	180	105	2,49 €
D-07200	16	315	160	7,34 €
D-07135	18	200	120	4,18 €
D-07216	18	315	160	9,09 €
D-07141	20	200	130	5,33 €
D-07222	20	315	160	11,53 €





# Vrtáky do dreva so šesťhrannou stopkou

## Ploché frézovacie vrtáky do dreva



objednávacie číslo	ks/bal.	ø (mm)	celková dĺžka (mm)	pracovná dĺžka (mm)	cena s DPH
P-58643	1	6	150	120	1,19 €
P-58659	1	8	150	120	1,30 €
P-58665	1	10	150	120	1,37 €
P-58671	1	12	150	120	1,42 €
P-58687	1	14	150	120	1,53 €
P-58693	1	15	150	120	1,57 €
P-58702	1	16	150	120	1,60 €
P-58713	1	18	150	120	1,70 €
P-58724	1	20	150	120	1,81 €
P-58730	1	22	150	120	1,98 €
P-58746	1	24	150	120	2,14 €
P-58752	1	25	150	120	2,45 €
P-58768	1	26	160	130	2,62 €
P-58774	1	28	160	130	2,81 €
P-58780	1	30	160	130	2,99 €
P-58796	1	32	160	130	3,35 €
P-58805	1	34	160	130	3,64 €
P-58811	1	35	160	130	3,70 €
P-58827	1	36	160	130	3,82 €



## Ploché frézovacie vrtáky do dreva



objednávacie číslo	ks/bal.	ø (mm)	celková dĺžka (mm)	pracovná dĺžka (mm)	cena s DPH
D-07674	1	6	150	120	1,27 €
D-07680	1	8	150	120	1,27 €
D-07696	1	10	150	120	1,17 €
D-07705	1	12	150	120	1,19 €
D-07711	1	14	150	120	1,21 €
D-07727	1	15	150	120	2,40 €
D-07733	1	16	150	120	2,52 €
D-07749	1	18	150	120	1,36 €
D-07755	1	20	150	120	1,61 €
D-07761	1	22	150	120	1,80 €
D-07777	1	24	150	120	1,76 €
D-07783	1	25	150	120	1,93 €
D-07799	1	26	160	130	1,91 €
D-07808	1	28	160	130	2,15 €
D-07814	1	30	160	130	2,49 €
D-07820	1	32	160	130	2,57 €
D-07836	1	34	160	130	2,58 €
D-07842	1	35	160	130	2,92 €
D-07858	1	36	160	130	2,81 €



# Vrtáky do dreva so šesťhrannou stopkou

Sada frézovacích vrtákov do dreva

objednávacie číslo	ks/bal.	ø (mm)	cena s DPH
P-80802	1	14	23,45 €
	1	16	
	1	18	
	1	20	
	1	22	
	1	24	
	1	26	
	1	28	
	1	30	





# Vrtáky do dreva s valcovou stopkou

## Špirálový vrták do dreva



objednávacie číslo	ks/bal.	ø (mm)	celková dĺžka (mm)	cena s DPH
P-57825	1	8	400	8,58 €
P-57831	1	10	400	9,89 €
P-57847	1	12	400	12,44 €
P-57853	1	14	400	14,33 €
P-57869	1	16	400	15,77 €
P-57875	1	18	400	20,17 €
P-57881	1	20	400	24,90 €
P-57897	1	22	400	31,07 €
P-57906	1	25	400	36,72 €
P-57912	1	26	400	43,80 €
P-57928	1	28	400	48,80 €
P-57934	1	30	400	53,99 €
P-57940	1	8	600	9,89 €
P-57956	1	10	600	11,46 €
P-57962	1	12	600	13,81 €
P-57978	1	14	600	15,80 €
P-57984	1	16	600	18,25 €
P-57990	1	18	600	24,35 €
P-58001	1	20	600	28,56 €
P-58017	1	22	600	33,23 €
P-58023	1	25	600	38,84 €
P-58039	1	26	600	44,19 €
P-58045	1	28	600	47,62 €
P-58051	1	30	600	53,20 €



# Vrtáky do dreva so šesťhrannou stopkou

## Vrtáky na pánty



objednávacie číslo	priemer (mm)	celková dĺžka (mm)	priemer stopky (mm)	cena s DPH
D-29935	25	127	11	11,62 €
D-29957	28	127	11	12,71 €
D-29963	32	127	11	14,22 €
D-29979	35	127	11	16,32 €
D-29985	38	127	11	16,76 €
D-29991	45	127	11	21,44 €
D-30003	51	127	11	22,04 €
D-30019	54	127	11	24,49 €
D-30025	57	127	11	33,56 €
D-30031	65	127	11	33,98 €
D-56518	92	127	11	57,37 €
D-56524	117	127	11	73,31 €

## Vrtáky na vrtanie dier pre pánty

Forstnerove vrtáky s vystred'ovacou špičkou a s 2 ostriami



objednávacie číslo	ks/bal.	ø (mm)	celková dĺžka (mm)	cena s DPH
P-58833	1	8	90	3,85 €
P-58849	1	10	90	4,16 €
P-58855	1	12	90	4,55 €
P-58861	1	14	90	5,06 €
P-58877	1	15	90	5,40 €
P-58883	1	16	90	5,68 €
P-58899	1	18	90	6,04 €
P-58908	1	20	90	6,26 €
P-58914	1	22	90	6,44 €
P-58920	1	24	90	6,81 €
P-58936	1	25	90	7,18 €
P-58942	1	26	90	7,64 €
P-58958	1	28	90	8,18 €
P-58964	1	30	90	8,52 €
P-58970	1	32	90	9,07 €
P-58986	1	34	90	9,64 €
P-58992	1	35	90	10,05 €
P-59003	1	36	90	10,39 €
P-59019	1	38	90	11,00 €
P-59025	1	40	90	12,24 €
P-59031	1	42	90	15,34 €
P-59047	1	45	90	15,34 €
P-58053	1	48	90	18,83 €
P-58069	1	50	90	18,83 €



# Vrtáky do kovov z rýchloreznej ocele (HSS)

## Vrtáky do kovov HSS s valcovitou stopkou

špička pod uhlom 135°



objednávacie číslo	ks/bal.	ø (mm)	celková dĺžka (mm)	cena s DPH
D-06236	10	1,50	40	2,29 €
D-06242	10	1,75	46	2,48 €
D-06258	10	2,00	49	3,39 €
D-06264	10	2,25	53	3,17 €
D-06270	10	2,50	57	3,77 €
D-06286	10	2,75	61	3,54 €
D-06292	10	3,00	61	5,32 €
D-06301	10	3,25	65	6,47 €
D-06317	10	3,50	70	6,56 €
D-06323	10	3,75	70	8,13 €
D-06339	10	4,00	75	8,28 €
D-06345	10	4,25	75	9,37 €
D-06351	10	4,50	80	7,80 €
D-06367	10	4,75	80	13,00 €
D-06373	10	5,00	86	12,17 €
D-06389	10	5,25	86	10,64 €
D-06395	10	5,50	93	11,48 €
D-06404	10	5,75	93	9,76 €
D-06410	10	6,00	93	17,04 €
D-06426	10	6,25	101	14,66 €
D-06432	10	6,50	101	12,67 €
D-06454	10	7,00	109	21,31 €
D-06460	10	7,25	109	22,67 €
D-06476	10	7,50	109	14,51 €
D-06482	10	7,75	117	34,60 €
D-06498	10	8,00	117	30,68 €
D-06507	5	8,25	117	17,39 €
D-06513	5	8,50	117	18,80 €
D-06529	5	8,75	125	20,88 €
D-06535	5	9,00	125	15,67 €
D-06557	5	9,50	125	20,37 €
D-06563	5	9,75	133	16,84 €
D-06579	5	10,00	133	27,97 €
D-06591	5	10,50	133	21,34 €
D-06600	5	11,00	142	33,65 €
D-06622	5	12,00	151	30,38 €
D-06638	5	12,50	151	34,25 €
D-06644	5	13,00	151	35,81 €



# Vrtáky do kovov z rýchloreznej ocele (HSS)

## Vrtáky do kovov HSS s valcovitou stopkou

špička pod uhlom 135°



objednávacie číslo	ks/bal.	ø (mm)	celková dĺžka (mm)	cena s DPH
D-09656	1	1,5	40	0,58 €
D-09662	1	2,0	49	0,65 €
D-09678	1	2,5	57	0,77 €
D-09684	1	3,0	61	0,78 €
D-09690	1	3,5	70	0,96 €
D-09709	1	4,0	75	1,25 €
D-09715	1	4,5	80	1,42 €
D-09721	1	5,0	86	1,58 €
D-09737	1	5,5	93	1,70 €
D-09743	1	6,0	93	1,94 €
D-09759	1	6,5	101	2,27 €
D-09765	1	7,0	109	2,78 €
D-09771	1	7,5	109	2,28 €
D-09787	1	8,0	117	3,51 €
D-09793	1	8,5	117	3,70 €
D-09802	1	9,0	125	4,60 €
D-09818	1	9,5	125	4,99 €
D-09824	1	10,0	133	6,00 €
D-09830	1	10,5	133	4,18 €
D-09846	1	11,0	142	7,08 €
D-09868	1	12,0	151	9,61 €
D-09874	1	12,5	151	8,27 €
D-09880	1	13,0	151	11,06 €



# Vrtáky do kovov z rýchloreznej ocele (HSS)

Vrtáky do kovov HSS-Co s valcovitou stopkou



objednávacie číslo	ks/bal.	ø (mm)	celková dĺžka (mm)	cena s DPH
D-17289	1	1,5	40	0,94 €
D-17295	1	2,0	49	1,02 €
D-17304	1	2,5	57	1,04 €
D-17310	1	3,0	61	1,45 €
D-17332	1	3,5	70	1,44 €
D-17348	1	4,0	75	1,57 €
D-17354	1	4,5	80	1,85 €
D-17360	1	5,0	86	2,16 €
D-17376	1	5,5	93	2,71 €
D-17382	1	6,0	93	2,58 €
D-17398	1	6,5	101	3,52 €
D-17407	1	7,0	109	3,95 €
D-17413	1	7,5	109	4,10 €
D-17429	1	8,0	117	5,98 €
D-17435	1	8,5	117	5,54 €
D-17441	1	9,0	125	6,46 €
D-17463	1	10,0	133	9,40 €
D-17479	1	10,5	133	10,10 €
D-17491	1	11,5	142	13,15 €
D-17500	1	12,5	151	14,59 €
D-17522	1	13,0	151	16,91 €





# Vrtáky do kovov z rýchloreznej ocele (HSS)

## Vrtáky do kovov HSS-G s valcovitou stopkou

DIN338, špička pod uhlom 135°



objednávacie číslo	ks/bal.	ø (mm)	celková dĺžka (mm)	cena s DPH
P-60115-10	10	1,00	34	2,32 €
P-75328-10	10	1,10	36	2,32 €
P-75334-10	10	1,20	38	2,68 €
P-60121-10	10	1,25	38	2,68 €
P-75340-10	10	1,30	38	2,68 €
P-75356-10	10	1,40	40	2,71 €
P-60137-10	10	1,50	40	2,68 €
P-75362-10	10	1,60	43	3,26 €
P-75378-10	10	1,70	43	3,26 €
P-60143-10	10	1,75	46	3,10 €
P-75384-10	10	1,80	46	3,26 €
P-75390-10	10	1,90	46	3,26 €
P-60159-10	10	2,00	49	3,10 €
P-75409-10	10	2,10	49	3,92 €
P-75415-10	10	2,20	53	3,92 €
P-60165-10	10	2,25	53	3,75 €
P-75421-10	10	2,30	53	3,92 €
P-75437-10	10	2,40	57	3,92 €
P-60171-10	10	2,50	57	3,75 €
P-75443-10	10	2,60	57	4,90 €
P-75459-10	10	2,70	61	4,90 €
P-60187-10	10	2,75	61	4,73 €
P-75465-10	10	2,80	61	4,90 €
P-75471-10	10	2,90	61	4,90 €
P-60193-10	10	3,00	61	4,73 €
P-75487-10	10	3,10	65	4,90 €
P-75493-10	10	3,20	65	4,90 €
P-60202-10	10	3,25	65	0,60 €
P-75502-10	10	3,30	65	6,01 €
P-75518-10	10	3,40	70	6,01 €
P-60218-10	10	3,50	70	6,01 €
P-75524-10	10	3,60	70	7,51 €
P-75530-10	10	3,70	70	7,51 €
P-60224-10	10	3,75	70	7,34 €
P-75546-10	10	3,80	75	7,51 €
P-75552-10	10	3,90	75	7,51 €
P-60230-10	10	4,00	75	7,34 €
P-75568-10	10	4,10	75	8,23 €
P-75574-10	10	4,20	75	8,23 €
P-60246-10	10	4,25	75	9,30 €
P-75580-10	10	4,30	80	9,47 €
P-75596-10	10	4,40	80	9,47 €
P-60252-10	10	4,50	80	7,34 €
P-75605-10	10	4,60	80	10,54 €
P-75611-10	10	4,70	80	10,54 €
P-60268-10	10	4,75	80	10,54 €
P-75627-10	10	4,80	86	10,54 €
P-75633-10	10	4,90	86	10,54 €
P-60274-10	10	5,00	86	10,54 €
P-75649-10	10	5,10	86	12,73 €
P-75655-10	10	5,20	86	12,73 €
P-60280-10	10	5,25	86	12,73 €
P-75661-10	10	5,30	86	12,73 €

objednávacie číslo	ks/bal.	ø (mm)	celková dĺžka (mm)	cena s DPH
P-75677-10	10	5,40	93	12,73 €
P-60296-10	10	5,50	93	1,27 €
P-75683-10	10	5,60	93	13,38 €
P-75708-10	10	5,80	93	13,38 €
P-75714-10	10	5,90	93	13,38 €
P-60311-10	10	6,00	93	13,38 €
P-75720-10	10	6,10	101	13,71 €
P-75736-10	10	6,20	101	13,71 €
P-60327-10	10	6,25	101	13,71 €
P-75742-10	10	6,30	101	13,71 €
P-75758-10	10	6,40	101	13,71 €
P-60333-10	10	6,50	101	13,71 €
P-75764-10	10	6,60	101	16,65 €
P-75770-10	10	6,70	101	16,65 €
P-60349-10	10	6,75	109	16,65 €
P-75786-10	10	6,80	109	16,65 €
P-75792-10	10	6,90	109	16,65 €
P-60355-10	10	7,00	109	16,65 €
P-75801-10	10	7,10	109	18,60 €
P-75817-10	10	7,20	109	18,60 €
P-75823-10	10	7,30	109	18,60 €
P-75839-10	10	7,40	109	18,60 €
P-60377-10	10	7,50	109	18,60 €
P-75845-10	10	7,60	117	18,60 €
P-75851-10	10	7,70	117	20,24 €
P-60383-10	10	7,75	117	20,07 €
P-75867-10	10	7,80	117	20,24 €
P-75873-10	10	7,90	117	2,01 €
P-60399-10	10	8,00	117	20,07 €
P-75889-5	5	8,10	117	2,38 €
P-75895-5	5	8,20	117	2,38 €
P-60408-5	5	8,25	117	12,08 €
P-75904-5	5	8,30	117	2,38 €
P-75910-5	5	8,40	117	2,38 €
P-60414-5	5	8,50	117	12,08 €
P-75926-5	5	8,60	125	2,81 €
P-75948-5	5	8,80	125	2,81 €
P-75954-5	5	8,90	125	2,81 €
P-60420-5	5	9,00	125	14,04 €
P-75960-5	5	9,10	125	3,10 €
P-75982-5	5	9,30	125	3,10 €
P-60436-5	5	9,50	125	15,67 €
P-76009-5	5	9,60	133	3,59 €
P-76015-5	5	9,70	133	3,59 €
P-76021-5	5	9,80	133	3,59 €
P-76037-5	5	9,90	133	3,59 €
P-60442-5	5	10,00	133	17,79 €
P-60458-5	5	10,50	133	19,91 €
P-60464-5	5	11,00	142	23,34 €
P-60470-5	5	11,50	142	25,13 €
P-60486-5	5	12,00	151	28,56 €
P-60492-5	5	12,50	151	31,11 €
P-60501-5	5	13,00	151	32,15 €



# Vrtáky do kovov z rýchloreznej ocele (HSS)

## Vrtáky do kovov HSS-G s valcovitou stopkou

DIN338, špička pod uhlom 135°



objednávacie číslo	ks/bal.	ø (mm)	celková dĺžka (mm)	cena s DPH
P-62991	1	1,0 × 90	90	2,96 €
P-63018	1	1,5 × 150	150	7,05 €
P-63024	1	2,0 × 125	125	3,33 €
P-63030	1	2,0 × 160	160	7,38 €
P-63046	1	2,0 × 200	200	9,01 €
P-63052	1	2,5 × 140	140	3,72 €
P-63068	1	2,5 × 180	180	8,58 €
P-63074	1	2,5 × 225	225	9,43 €
P-63080	1	3,0 × 150	150	3,74 €
P-63096	1	3,0 × 190	190	7,25 €
P-63105	1	3,0 × 240	240	11,69 €
P-63111	1	3,5 × 165	165	5,86 €
P-63127	1	3,5 × 210	210	9,20 €
P-63133	1	3,5 × 265	265	11,98 €
P-63149	1	4,0 × 175	175	6,43 €
P-63155	1	4,0 × 220	220	10,22 €
P-63161	1	4,0 × 280	280	13,02 €
P-63177	1	4,5 × 185	185	6,51 €
P-63199	1	4,5 × 295	295	18,70 €
P-63208	1	5,0 × 195	195	7,74 €
P-63214	1	5,0 × 245	245	13,25 €
P-63220	1	5,0 × 315	315	19,94 €
P-63236	1	5,5 × 205	205	10,77 €
P-63242	1	5,5 × 260	260	15,91 €

objednávacie číslo	ks/bal.	ø (mm)	celková dĺžka (mm)	cena s DPH
P-63264	1	6,0 × 205	205	10,77 €
P-63270	1	6,0 × 260	260	15,91 €
P-63286	1	6,0 × 330	330	21,05 €
P-63292	1	6,5 × 215	215	11,59 €
P-63317	1	6,5 × 350	350	22,36 €
P-63323	1	7,0 × 225	225	12,99 €
P-63351	1	7,5 × 225	225	13,61 €
P-63367	1	7,5 × 290	295	21,61 €
P-63389	1	8,0 × 240	240	14,82 €
P-63395	1	8,0 × 305	305	22,72 €
P-63404	1	8,0 × 390	390	35,09 €
P-63448	1	9,0 × 250	250	22,03 €
P-63454	1	9,0 × 320	320	29,90 €
P-63476	1	9,5 × 250	250	22,03 €
P-63507	1	10,0 × 265	265	23,17 €
P-63513	1	10,0 × 340	340	32,15 €
P-63529	1	10,0 × 430	430	44,59 €
P-63563	1	11,0 × 280	280	26,90 €
P-63622	1	12,0 × 295	295	31,66 €
P-63638	1	12,0 × 380	380	44,23 €
P-63650	1	12,5 × 295	295	31,99 €
P-63688	1	13,0 × 295	295	34,76 €
P-63694	1	13,0 × 380	380	49,35 €



# Vrtáky do kovov z rýchloreznej ocele (HSS)

## Vrtáky do kovov HSS-GM2 s valcovitou stopkou

DIN338, špička pod uhlom 130°



objednávacie číslo	ks/bal.	ø (mm)	celková dĺžka (mm)	cena s DPH
P-60545-10	10	1	34	4,73 €
P-62496-10	10	1	56	9,14 €
P-60567-10	10	1,5	40	5,12 €
P-62505-10	10	1,5	70	10,51 €
P-60589-10	10	2	49	5,55 €
P-62511-10	10	2	85	11,59 €
P-60595-10	10	2,25	53	6,04 €
P-60604-10	10	2,5	57	6,04 €
P-62527-10	10	2,5	95	12,40 €
P-60610-10	10	2,75	61	6,27 €
P-60626-10	10	3	61	7,51 €
P-62533-10	10	3	100	14,36 €
P-60648-10	10	3,5	70	9,47 €
P-62549-10	10	3,5	112	18,28 €
P-62555-10	10	4	119	20,56 €
P-60682-10	10	4,5	80	12,40 €
P-62561-10	10	4,5	126	23,50 €
P-60698-10	10	4,75	80	15,01 €
P-60707-10	10	5	86	15,01 €
P-62577-10	10	5	132	28,72 €
P-60729-10	10	5,5	93	17,63 €
P-62583-10	10	5,5	139	35,90 €

objednávacie číslo	ks/bal.	ø (mm)	celková dĺžka (mm)	cena s DPH
P-60741-10	10	6	93	19,94 €
P-62599-10	10	6	139	39,98 €
P-60757-10	10	6,25	101	17,96 €
P-60763-10	10	6,5	101	23,30 €
P-62608-10	10	6,5	148	46,02 €
P-60785-10	10	7	109	27,74 €
P-62614-10	10	7	156	53,20 €
P-60800-10	10	7,5	109	31,53 €
P-60822-10	10	8	117	35,68 €
P-62636-10	10	8	165	68,54 €
P-60844-5	5	8,5	117	20,56 €
P-62642-5	5	8,5	165	39,00 €
P-60850-5	5	9	125	23,34 €
P-60866-5	5	9,5	125	26,01 €
P-60872-5	5	10	133	30,52 €
P-62670-5	5	10	184	57,61 €
P-60888-5	5	10,5	133	33,78 €
P-60894-5	5	11	142	38,35 €
P-60903-5	5	11,5	142	42,11 €
P-60919-5	5	12	151	47,82 €
P-60925-5	5	12,5	151	51,57 €
P-60931-5	5	13	151	54,84 €



# Vrtáky do kovov z rýchloreznej ocele (HSS)

## Vrtáky do kovov HSS-Co 5 %

DIN338, špička pod uhlom 130°



objednávacie číslo	ks/bal.	ø (mm)	celková dĺžka (mm)	cena s DPH
P-61416-10	10	1,00	34	6,20 €
P-61438-10	10	1,50	40	7,08 €
P-76087-10	10	1,60	43	8,36 €
P-61450-10	10	2,00	49	7,34 €
P-76146-10	10	2,30	53	8,87 €
P-76152-10	10	2,40	57	9,83 €
P-61472-10	10	2,50	57	9,05 €
P-76168-10	10	2,60	57	10,23 €
P-76174-10	10	2,70	61	10,23 €
P-76180-10	10	2,80	61	10,23 €
P-76196-10	10	2,90	61	9,81 €
P-61494-10	10	3,00	61	9,79 €
P-76205-10	10	3,10	65	11,61 €
P-76211-10	10	3,20	65	11,75 €
P-61503-10	10	3,25	65	11,75 €
P-76227-10	10	3,30	65	10,96 €
P-76233-10	10	3,40	70	13,38 €
P-61519-10	10	3,50	70	11,75 €
P-76255-10	10	3,70	70	14,19 €
P-61525-10	10	3,75	70	13,71 €
P-76277-10	10	3,90	75	14,19 €
P-61531-10	10	4,00	75	13,71 €
P-76283-10	10	4,10	75	15,03 €
P-76299-10	10	4,20	75	15,34 €
P-61547-10	10	4,25	75	15,34 €
P-76308-10	10	4,30	80	15,33 €
P-61553-10	10	4,50	80	15,34 €
P-76320-10	10	4,60	80	17,46 €
P-76336-10	10	4,70	80	19,15 €
P-76342-10	10	4,80	86	18,34 €
P-76358-10	10	4,90	86	18,19 €
P-61575-10	10	5,00	86	18,28 €
P-76364-10	10	5,10	86	22,47 €

objednávacie číslo	ks/bal.	ø (mm)	celková dĺžka (mm)	cena s DPH
P-76370-10	10	5,20	86	22,36 €
P-61581-10	10	5,25	86	22,52 €
P-76386-10	10	5,30	86	23,43 €
P-76392-10	10	5,40	93	23,43 €
P-61597-10	10	5,50	93	22,52 €
P-76401-10	10	5,60	93	25,99 €
P-76417-10	10	5,70	93	25,99 €
P-76423-10	10	5,80	93	25,99 €
P-76439-10	10	5,90	93	23,68 €
P-61612-10	10	6,00	93	24,81 €
P-76445-10	10	6,10	101	29,53 €
P-76451-10	10	6,20	101	29,94 €
P-76467-10	10	6,30	101	30,36 €
P-76473-10	10	6,40	101	31,74 €
P-76489-10	10	6,60	101	38,30 €
P-76495-10	10	6,70	101	36,56 €
P-76504-10	10	6,80	109	35,44 €
P-61656-10	10	7,00	109	37,11 €
P-76548-10	10	7,30	109	40,08 €
P-61678-10	10	7,50	109	47,39 €
P-61690-10	10	8,00	117	49,94 €
P-76607-5	5	8,10	117	26,20 €
P-76613-5	5	8,20	117	27,63 €
P-61705-5	5	8,25	117	27,91 €
P-61715-5	5	8,50	117	27,97 €
P-61721-5	5	9,00	125	32,31 €
P-61743-5	5	10,00	133	40,47 €
P-61759-5	5	10,50	133	46,02 €
P-61765-5	5	11,00	142	52,88 €
P-61771-5	5	11,50	142	57,61 €
P-61787-5	5	12,00	151	64,95 €
P-61793-5	5	12,50	151	70,67 €
P-61802-5	5	13,00	151	76,21 €



# Vrtáky do kovov z rýchloreznej ocele (HSS)

## Vrtáky do kovov HSS-Co 5 %

DIN340, špička pod uhlom 130°



objednávacie číslo	ks/bal.	ø (mm)	celková dĺžka (mm)	cena s DPH
P-62767-10	10	2,00 × 85	85	19,26 €
P-62773-10	10	2,50 × 95	95	21,22 €
P-62804-10	10	4,00 × 119	119	34,27 €
P-62810-10	10	4,50 × 126	126	38,84 €
P-62826-10	10	5,00 × 132	132	46,35 €
P-62832-10	10	5,50 × 139	139	49,61 €
P-62848-10	10	6,00 × 139	139	54,84 €
P-62882-5	5	8,00 × 165	165	56,96 €
P-62929-5	5	10,0 × 184	184	91,59 €
P-62985-5	5	13,0 × 205	205	172,50 €



objednávacie číslo	ø (mm)	celková dĺžka (mm)	pracovná dĺžka (mm)	cena s DPH
D-17289	1,5	40		0,94 €
D-17295	2	49		1,02 €
D-17304	2,5	57		1,04 €
D-17310	3	61		1,45 €
D-17326	3,2	65		1,39 €
D-17332	3,5	70		1,44 €
D-17348	4	75		1,57 €
D-17354	4,5	80		1,85 €
D-17360	5	86		2,16 €
D-17376	5,5	93		2,71 €
D-17382	6	93		2,58 €
D-17398	6,5	101		3,52 €
D-17407	7	109		3,95 €
D-17413	7,5	109		4,10 €
D-17429	8	117		5,98 €
D-17435	8,5	117		5,54 €
D-17441	9	125		6,46 €
D-17457	9,5	125		7,72 €
D-17463	10	133		9,40 €
D-17479	10,5	133		10,10 €
D-17485	11	142		11,73 €
D-17491	11,5	142		13,15 €
D-17500	12	151		14,59 €
D-17516	12,5	151		15,34 €
D-17522	13	151		16,91 €



# Vrtáky do kovov z rýchloreznej ocele (HSS)

## Vrtáky do kovov HSS-Co 8 % s valcovitou stopkou

DIN338, špička pod uhlom 130°



objednávacie číslo	ks/bal.	ø (mm)	celková dĺžka (mm)	cena s DPH
P-61880-10	10	2	49	13,55 €
P-61905-10	10	2,5	57	15,34 €
P-61927-10	10	3	61	16,32 €
P-61949-10	10	3,5	70	18,28 €
P-61955-10	10	3,75	70	21,80 €
P-61961-10	10	4	75	22,20 €
P-61977-10	10	4,25	75	24,15 €
P-61983-10	10	4,5	80	24,15 €
P-62000-10	10	5	86	27,74 €
P-62022-10	10	5,5	93	37,07 €
P-62038-10	10	5,75	93	40,05 €
P-62044-10	10	6	93	37,54 €
P-62066-10	10	6,5	101	44,46 €
P-62072-10	10	6,75	101	42,68 €
P-62094-10	10	7,5	109	60,38 €
P-62103-10	10	8	117	73,11 €
P-62147-5	5	10	133	59,89 €



# Vrtáky do kovov z rýchloreznej ocele (HSS)

## Vrtáky do kovov HSS-TiN s valcovitou stopkou

DIN338, špička pod uhlom 135°



objednávacie číslo	ks/bal.	ø (mm)	celková dĺžka (mm)	cena s DPH
P-60981-10	10	1	34	4,90 €
P-61008-10	10	1,5	40	5,22 €
P-61020-10	10	2	49	5,88 €
P-61042-10	10	2,5	57	6,20 €
P-61064-10	10	3	61	8,16 €
P-61070-10	10	3,25	65	9,79 €
P-61086-10	10	3,5	70	9,86 €
P-61101-10	10	4	75	10,44 €
P-61117-10	10	4,25	75	12,73 €
P-61123-10	10	4,5	80	12,73 €
P-61145-10	10	5	86	15,01 €
P-61167-10	10	5,5	93	17,63 €
P-61173-10	10	5,75	93	20,30 €
P-61189-10	10	6	93	20,30 €
P-61204-10	10	6,5	101	22,85 €
P-61226-10	10	7	109	27,09 €
P-61248-10	10	7,5	109	31,01 €
P-61260-10	10	8	117	34,99 €
P-61282-5	5	8,5	117	20,07 €
P-61298-5	5	9	125	23,34 €
P-61307-5	5	9,5	125	19,63 €
P-61313-5	5	10	133	30,58 €
P-61329-5	5	10,5	133	32,97 €
P-61335-5	5	11	142	30,82 €
P-61341-5	5	11,5	142	41,13 €
P-61357-5	5	12	151	46,02 €
P-61367-5	5	12,5	151	50,92 €
P-61379-5	5	13	151	54,02 €



\*\*\*\*\*

# Vrtáky do kovov z rýchloreznej ocele (HSS)

## Obojstranné vrtáky HSS-G

Vhodné na vytváranie otvorov pre nity a predvrtávanie závitov.



objednávacie číslo	ks/bal.	ø (mm)	cena s DPH
B-26652	10	2	3,12 €
B-26668	10	3	4,78 €
B-26674	10	3,1	8,87 €
B-26680	10	3,2	5,14 €
B-26696	10	3,3	5,84 €
B-26705	10	3,5	6,47 €
B-26711	10	3,8	6,20 €
B-26727	10	4	7,90 €
B-26733	10	4,1	8,40 €
B-26749	10	4,2	7,87 €
B-26755	10	4,3	8,70 €
B-26777	10	4,8	10,70 €
B-26783	10	4,9	11,29 €
B-26799	10	5	13,96 €
B-26808	10	5,1	11,32 €
B-26814	10	5,2	13,16 €
B-26836	10	6	12,44 €

## Sada vrtákov do kovu HSS-R Mforce

\*\*\*



objednávacie číslo	ks/bal.	ø (mm)	cena s DPH
D-30508	5	4, 5, 6, 8, 10	18,33 €

# Vrtáky do kovov z rýchloreznej ocele (HSS)

18-dielna sada vrtákov do muriva/železa/dreva

\*\*\*



objednávacie číslo	popis	cena s DPH
P-23818	HSS 3; 4; 5; 6; 8; 10 murivo 3; 4; 5; 6; 8; 10 drevo 3; 4; 5; 6; 8; 10	21,51 €

Sada titánových vrtákov

\*\*\*\*



objednávacie číslo	popis	cena s DPH
P-23759	HSS Tin 2; 3; 4; 5; 6; 8	8,80 €

# Vrtáky do kovov z rýchloreznej ocele (HSS)

## Sada vrtákov do kovu HSS-G

špička pod uhlom 135°

\*\*\*\*



objednávacie číslo	ks/bal.	ø (mm)	celková dĺžka (mm)	cena s DPH
P-60539	30	1	40	805,72 €
	30	1,5	40	
	60	2	49	
	60	2,5	57	
	100	3	61	
	80	3,5	70	
	100	4	75	
	30	4,5	80	
	30	5	86	
	20	5,5	93	
	20	6	93	
	10	6,5	101	
	10	7	109	
	5	7,5	109	
	10	8	117	
	5	8,5	117	
	10	9	125	
	5	9,5	125	
	10	10	133	
	5	10,5	133	
5	11	142		
5	11,5	142		
5	12	151		
5	12,5	151		
5	13	151		

## 170 ks sada vrtákov do železa

\*\*\*\*



objednávacie číslo	ks/bal.	ø (mm)	cena s DPH
D-30564	10	1	268,59 €
	10	1,5	
	10	2	
	10	2,5	
	10	3	
	10	3,5	
	10	4	
	10	4,5	
	10	5	
	10	5,5	
	10	6	
	10	6,5	
	10	7	
	10	7,5	
	10	8	
	5	8,5	
	5	9	
	5	9,5	
	5	10	

# Vrtáky do kovov z rýchloreznej ocele (HSS-G)

19 dielna sada vrtákov do kovov HSS-G



\*\*\*\*\*

objednávacie číslo	ks/bal.	ø (mm)	cena s DPH
	1	1	
	1	1,5	
	1	2	
	1	2,5	
	1	3	
	1	3,5	
	1	4	
	1	4,5	
	1	5	
P-73673	1	5,5	35,22 €
	1	6	
	1	6,5	
	1	7	
	1	7,5	
	1	8	
	1	8,5	
	1	9	
	1	9,5	
	1	10	

19 dielna sada vrtákov HSS-G

špička pod uhlom 135°



\*\*\*\*\*

objednávacie číslo	ks/bal.	ø (mm)	celková dĺžka (mm)	cena s DPH
	1	1	40	
	1	1,5	40	
	1	2	49	
	1	2,5	57	
	1	3	61	
	1	3,5	70	
	1	4	75	
	1	4,5	80	
	1	5	86	
P-60517	1	5,5	93	26,70 €
	1	6	93	
	1	6,5	101	
	1	7	109	
	1	7,5	109	
	1	8	117	
	1	8,5	117	
	1	9	125	
	1	9,5	125	
	1	10	133	

# Vrtáky do kovov z rýchloreznej ocele (HSS-G)

25 dielna sada vrtákov do kovov HSS-G



objednávacie číslo	ks/bal.	ø (mm)	cena s DPH
P-73689	1	1	68,54 €
	1	1,5	
	1	2	
	1	2,5	
	1	3	
	1	3,5	
	1	4	
	1	4,5	
	1	5	
	1	5,5	
	1	6	
	1	6,5	
	1	7	
	1	7,5	
	1	8	
	1	8,5	
	1	9	
	1	9,5	
	1	10	
	1	10,5	
	1	11	
	1	11,5	
	1	12	
	1	12,5	
	1	13	

25 dielna sada vrtákov HSS-G

špička pod uhlom 135°



objednávacie číslo	ks/bal.	ø (mm)	celková dĺžka (mm)	cena s DPH
P-60523	1	1	40	56,14 €
	1	1,5	40	
	1	2	49	
	1	2,5	57	
	1	3	61	
	1	3,5	70	
	1	4	75	
	1	4,5	80	
	1	5	86	
	1	5,5	93	
	1	6	93	
	1	6,5	101	
	1	7	109	
	1	7,5	109	
	1	8	117	
	1	8,5	117	
	1	9	125	
	1	9,5	125	
	1	10	133	
	1	10,5	133	
	1	11	142	
	1	11,5	142	
	1	12	151	
	1	12,5	151	
	1	13	151	

# Vrtáky do kovov z rýchloreznej ocele

## 21-dielna sada vrtákov a bitov

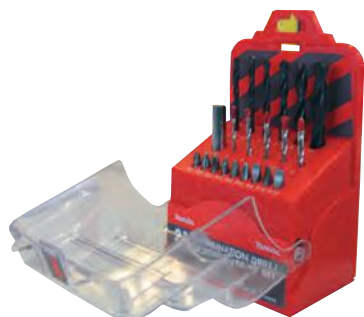

\*\*\*\*\*

objednávacie číslo	obsah	cena s DPH
P-30829	6 vrtákov HSS: $\varnothing$ 4; 4,5; 5; 6; 8; 10 mm 5 vrtákov do kameňa: $\varnothing$ 3; 4; 5; 5,5; 6 mm Magnetický držiak skrutkovacích hrotov 2 1/4" Skrutkovacie hroty 9 x 25 mm: 3 ks Pozidriv: PZ1, PZ2, PZ3 3 ks Phillips: 1; 2; 3 3 ks na rovnú drážku: 6-8; 8-10; 10-12	7,36 €

## 13-dielna sada vrtákov do kovu HSS-R



\*\*\*\*\*

objednávacie číslo	obsah	cena s DPH
D-54075	1,5/2/2,5/3/3,2/3,5/4/4,5/4,8/5/5,5/6/6,5 mm	6,29 €

## 19-dielna sada vrtákov do kovu HSS-R



\*\*\*\*\*

objednávacie číslo	obsah	cena s DPH
D-54081	1 ks 1/1,5/2/2,5/3/3,5/4/4,5/ 5/5,5/6/6,5/7/7,5/8/8,5/9/9,5/10mm	16,08 €

## 5-dielna sada vrtákov s 1/4" upínaním



\*\*\*\*\*

objednávacie číslo	obsah	cena s DPH
D-20769	$\varnothing$ 5; 6 do dreva $\varnothing$ 5; 6; 8 HSS-TIN do železa	11,43 €
D-23759	$\varnothing$ 5; 6 do dreva $\varnothing$ 5; 6 HSS-TIN do železa $\varnothing$ 6 HM CT do tehly a muríva	10,20 €

# Stupňovité vrtáky

## Stupňovité vrtáky HSS so špirálovou drážkou

Na vrtanie do železa, ocele, liatiny a kovov

\*\*\*\*\*



objednávacie číslo	počet stupňov	materiál	ø (mm)	cena s DPH
P-69892	9	HSS-G	4-12	23,99 €
P-69901	9	HSS-G	4-20	36,49 €
P-69917	14	HSS-G	4-30	78,30 €
P-69923	13	HSS-G	6-30	76,61 €
P-69939	12	HSS-G	6-38	109,77 €
P-69945	12	HSS-G	6-37	107,88 €

## Sada stupňovitých vrtákov HSS so špirálovou drážkou

Na vrtanie do legovaných zliatín ocele, atď.

\*\*\*\*\*



objednávacie číslo	počet stupňov	materiál	ø (mm)	cena s DPH
P-69951	4-12	HSS-G	4-12	137,81 €
	4-20		4-20	
	4-30		4-30	

## Stupňovité vrtáky HSS-Co + TiN so špirálovou drážkou

Na vrtanie do legovaných zliatín ocele, nehrdzavejúcej ocele, atď.

\*\*\*\*\*



objednávacie číslo	počet stupňov	materiál	ø (mm)	cena s DPH
P-69967	9	HSS-CO+TiAIN	4-12	34,01 €
P-69973	9	HSS-CO+TiAIN	4-20	54,84 €
P-69989	14	HSS-CO+TiAIN	4-30	121,58 €
P-69995	13	HSS-CO+TiAIN	6-30	119,20 €
P-70007	12	HSS-CO+TiAIN	6-38	172,57 €
P-70013	12	HSS-CO+TiAIN	6-37	167,35 €

## Sada stupňovitých vrtákov HSS-Co + TiN so špirálovou drážkou

Na vrtanie do legovaných zliatín ocele, nehrdzavejúcej ocele, atď.

\*\*\*\*\*



objednávacie číslo	počet stupňov	materiál	ø (mm)	cena s DPH
P-70029	4-12	HSS-CO+TiAIN	4-12	207,33 €
	4-20		4-20	
	4-30		4-30	



# Záhlbníkové vrtáky

Záhlbníkový trojbrítý vrták do kovu HSS 90°



\*\*\*\*\*

objednávacie číslo	ø (mm)	cena s DPH
P-73514	4,3	4,42 €
P-73520	5,3	4,42 €
P-73536	6,3	4,78 €
P-73542	8,3	5,53 €
P-73558	9,4	7,02 €
P-73564	10,4	7,12 €
P-73570	12,4	8,78 €
P-73586	16,5	12,47 €

Záhlbníkový trojbrítý vrták do kovu HSS-CO 90°



\*\*\*\*\*

objednávacie číslo	ø (mm)	cena s DPH
P-73601	6,3	8,49 €
P-73617	8,3	10,80 €
P-73623	10,4	12,83 €
P-73639	12,4	16,32 €
P-73645	16,5	23,34 €

Záhlbníkový vrták do kovu HSS 90°



\*\*\*\*\*

objednávacie číslo	ø (mm)	cena s DPH
P-73651	10	8,16 €
P-73667	15	11,64 €

Sada záhlbníkových trojbrítých vrtákov HSS

\*\*\*\*\*



objednávacie číslo	obsah	cena s DPH
P-73592	6 ks (6,3 mm, 8,3 mm, 10,4 mm, 12,4 mm, 16,5 mm, 20,5 mm)	56,53 €

# Vrtáky do kovov / skla / kameňa / dreva

## Vrtáky do kovov HSS-TiN so stopkou 1/4"

\*\*\*

### Vlastnosti a prednosti TiN (nitridu titánu)

TiN (nitrid titánu) je chemická zlúčenina titánu a dusíka. Materiál sa vyznačuje dobrými vlastnosťami pri trení a preto je zaujímavý pre systémy so zvláštnymi požiadavkami na minimálne opotrebovanie.

Keramický materiál sa okrem dlhej životnosti vyznačuje nasledujúcimi pozitívnymi vlastnosťami:

- dlhá životnosť
- veľmi vysoká tvrdosť a odolnosť voči korózii
- zvýšená rýchlosť posuvu a vrtania
- žiadne lepenie triesok na špičke a ostríach



objednávacie číslo	ks/bal.	ø (mm)	cena s DPH
D-14928	1	3,0	1,30 €
D-14934	1	3,2	1,40 €
D-16081	1	3,3	1,57 €
D-14940	1	4,0	1,55 €
D-14956	1	4,2	1,78 €
D-14962	1	5,0	1,90 €
D-14978	1	6,0	2,48 €
D-15827	1	8,0	5,29 €
D-15833	1	10,0	7,83 €
D-15849	1	12,0	12,11 €
D-15855	1	13,0	13,85 €

## Vrtáky do dreva s 1/4" šesťhrannou stopkou

\*\*\*



objednávacie číslo	ks/bal.	ø (mm)	cena s DPH
D-15861	1	3,0	1,08 €
D-15877	1	4,0	1,14 €
D-15883	1	5,0	1,27 €
D-15899	1	6,0	1,34 €
D-15908	1	8,0	1,69 €
D-15914	1	10,0	1,83 €
D-15920	1	12,0	2,33 €
D-15936	1	15,0	3,40 €

## Vrtáky do skla s 1/4" šesťhrannou stopkou

\*\*\*



objednávacie číslo	ks/bal.	ø (mm)	celková dĺžka (mm)	cena s DPH
D-15942	1	4,0	65	2,72 €
D-15958	1	5,0	65	2,80 €
D-15964	1	6,0	65	2,83 €
D-15970	1	8,0	70	3,17 €
D-15986	1	10,0	80	3,86 €

## Vrtáky do skla s valcovou stopkou

\*\*\*\*\*



objednávacie číslo	ks/bal.	ø (mm)	celková dĺžka (mm)	cena s DPH
P-60012	1	3	65	3,02 €
P-60028	1	4	65	3,20 €
P-60034	1	5	65	3,38 €
P-60040	1	6	65	3,59 €
P-60056	1	7	70	3,84 €
P-60062	1	8	70	3,98 €
P-60078	1	9	70	4,42 €
P-60084	1	10	98	4,73 €
P-60090	1	12	98	5,70 €
P-60109	1	13	98	6,73 €

# Vrtáky do kovov / skla / kameňa / dreva

## Vrtáky do kameňa s valcovitou stopkou

\*\*\*



objednávacie číslo	ks/bal.	ø (mm)	celková dĺžka (mm)	cena s DPH
D-05234	1	4	70	0,82 €
D-05240	1	5	85	0,79 €
D-05256	1	6	100	0,79 €
D-05262	1	6	150	0,83 €
D-05290	1	8	110	0,83 €
D-05309	1	8	150	0,86 €
D-05321	1	10	150	1,17 €
D-05343	1	12	150	1,40 €
D-17728	1	12	600	5,10 €
D-05359	1	13	150	1,66 €
D-05365	1	14	150	1,86 €
D-05371	1	15	150	2,08 €
D-17734	1	16	600	4,17 €

## 9-dielna sada vrtákov do kovov/kameňa/dreva s valcovitou stopkou

\*\*\*



objednávacie číslo		cena s DPH
D-08660	ø mm 5,6,8 do kovov HSS-TiN; ø mm 5,6,8 do kameňa HM ø mm 5,6,8 do dreva.	9,61 €

## 21-dielna sada vrtákov do kovov/kameňa/dreva s valcovitou stopkou

\*\*\*\*\*



objednávacie číslo		cena s DPH
B-44884	Ø mm 2×3, 2×4, 5, 6, 8 mm HSS Ø mm 2×3, 2×4, 5, 6, 8 mm drevo Ø mm 2×3, 2×4, 5, 6, 8 mm kameň	31,40 €

## 5-dielna sada vrtákov do kameňa s valcovitou stopkou

\*\*\*



objednávacie číslo	ks/bal.	ø (mm)	celková dĺžka (mm)	cena s DPH
D-05175	1	4	70	4,53 €
	1	5	85	
	1	6	100	
	1	8	110	
	1	10	110	

# Sady vrtákov a skrutkovacích hrotov

\*\*\*\*

## 34-dielna sada vrtákov a hrotov



objednávacie číslo	cena s DPH
D-36980	31,59 €

obsah sady:  
 vrták HSS 2; 2,5; 3; 3,5; 4; 4,5; 5  
 vrták do dreva 4; 5; 6; 7; 8  
 vrták do kameňa 4; 5; 6; 7; 8  
 šesťhran 1/4" nástrčkový ťahovák vel. 7; 8; 10  
 záhlbníkový vrták  
 držiak bitov 50 mm  
 šesťhran 1/4" 25 mm PH1, PH2, PH3, PH4  
 šesťhran 1/4" 25 mm PZ1, PZ2, PZ3, PZ4  
 šesťhran 1/4" 25 mm T20, T25, T30  
 šesťhran 1/4" 25 mm plochý bit 1 × 1,0, 1 × 1,2, 1 × 1,6

\*\*\*\*

## 71-dielna sada vrtákov a hrotov



objednávacie číslo	cena s DPH
D-33691	74,58 €

obsah sady:  
 vrták HSS TiN 1,5; 2; 2,5; 3; 3,5; 4; 4,5; 5; 5,5; 6; 6,5; 7  
 vrták do dreva 4; 5; 6; 8; 10  
 vrták do kameňa 3; 4; 6; 8  
 vrták plochý do dreva 8; 15; 20  
 šesťhran 1/4" nástrčkový ťahovák vel. 8; 10; 12; 13  
 zalamovací nôž  
 pásmo 3 m  
 plastový doraz bitov  
 plastový držiak bitov  
 záhlbníkový vrták  
 magnetický držiak bitov 50 mm  
 šesťhran 1/4" 25 mm PH1 (2×), PH2 (2×), PH3 (2×)  
 šesťhran 1/4" 25 mm PZ1 (2×), PZ2 (2×), PZ3 (2×)  
 šesťhran 1/4" 25 mm T20, T25, T30, T40  
 šesťhran 1/4" 25 mm plochý bit 1 × 1, 1 × 1,2, 1 × 1,6  
 šesťhran 1/4" 25 mm šesťhran 3, 4, 5, 6  
 šesťhran 1/4" 50 mm 10 bitov

\*\*\*\*

## 100 dielna sada príslušenstva



objednávacie číslo	cena s DPH
B-54520	47,82 €

# Sady vrtákov a skrutkovacích hrotov

\*\*\*\*

## 104-dielna sada vrtákov/skrutkovacích hrotov



objednávacie číslo	cena s DPH
D-31778	75,25 €

obsah sady:

Bity: 50 mm dĺžka: 1×PH2 1×PH3 1×PH4 1×PZ2 1×PZ3 1×PZ4 1×T20 1×T25 1×T30 1×T40;

Inbus: 3, 4, 5, 6; plochý bit: 5,5 - 6,5 - 2×8

25 mm dĺžka: 2×PH1 3×PH2 3×PH3 2×PH4 2×PZ1 3×PZ2 3×PZ3 2×PZ4 3×T20 3×T25 2×T30 2×T40; Inbus: 3, 4, 5, 6; plochý bit: 2×5, 3×6, 8

1 × držiak bitu 50 mm

1 × rýchlovýmenný držiak bitu 50 mm

1 × skrutovač na bity

Vrtáky: HSS-TiN: 1,5 - 2,0 - 2,5 - 3,0 - 3,5 - 4,0 - 4,5 - 5,0 - 5,5 - 6,0 - 6,5 - 7,0 - 8,0 - 10,0 mm

drevo: 3, 4, 5, 6, 7, 8, 10 mm

kameň: 3, 4, 5, 6, 8 mm

frézovací vrták do dreva: 8, 15, 20 mm

nástrčkový kľúč: 8, 10, 12, 13

1 × záhlbník

1 × záhlbníkový vrták

1 × orezávací nôž

1 × 3,5 m meter

1 × vodováha

\*\*\*\*

## 200-dielna sada vrtákov a hrotov



objednávacie číslo	cena s DPH
D-37194	173,65 €

obsah sady:

Bity: 50 mm dĺžka: 1×PH0 1×PH1 2×PH2 1×PH3 1×PZ0 3×PZ1

5×PZ2 1×PZ3 1×PZ4 3×T10 2×T15 2×T20 2×T25

1×T30 3×T40; Inbus: 3, 4, 5, 6, 7

25 mm dĺžka: 1×PH0 2×PH1 10×PH2 2×PH3 1×PZ0 2×PZ1

10×PZ2 2×PZ3 2×T10 2×T15 2×T20 2×T25

10×T30 1×T40; Inbus: 2×3, 2×4, 2×5, 2×6, 2×8

plochý bit: 2×S0,5 - 2×S0,6 - 2×S0,8 - 2×S1,0 - 2×S1,2

1 × rýchlopínací držiak bitu 50 mm

1 × skrutovač na bity

1 × kliešte

1 × kliešte odstrihávacie

1 × baterka LED

1 × orezávací nôž

1 × meter

1 × vodováha

Vrtáky: HSS-TiN: 1 - 1,5 - 2,0 - 2,5 - 3,0 - 3,2 - 3,5 - 4,0 - 4,5 - 5,0 -

5,5 - 6,0 - 6,5 - 7,0 - 8,0 - 10,0 mm

drevo: 3, 4, 5, 6, 7, 8, 10 mm

kameň: 3, 4, 5, 6, 7, 8, 10, 8×300, 10×300 mm

frézovací vrták do dreva: 8, 15, 20 mm

nástrčkový kľúč: 5 - 5,5 - 6 - 7 - 8 - 9 - 10 - 11 - 12 13

orech: 5, 6, 7, 8, 9, 10, 11, 13

vykružovák: 32, 38, 45, 54, 68

rezač: 3, 5, 8, 10 mm

1 × záhlbník

1 × uhlový nastaviteľ na bity

1 × šablóna na vrtanie

1 × nastavovací kľúč



# Sady vrtákov a skrutkovacích hrotov

\*\*\*\*

## 91-dielna sada vrtákov/skrutkovacích hrotov a gola kľúčov



objednávacie číslo	cena s DPH
P-46470	76,64 €

\*\*\*\*

## 99-dielna sada vrtákov/skrutkovacích hrotov



### obsah sady:

- vrták HSS TiN 1; 1,5; 2; 2,5; 3; 3,5; 4; 4,5; 5; 5,5; 6; 6,5; 7
- vrták do dreva 3; 5; 6; 8; 10
- vrták do kameňa 3; 4; 5; 5,5; 6; 6,5; 7; 8; 9; 10
- plastový doraz bitov 2 ks
- plastový držiak bitov 2 ks
- jamkovač
- plastový doraz bitov 3 ks
- plastový držiak bitov 2 ks
- jamkovač
- magnetický držiak bitov 60 mm
- šesthran 1/4" 25 mm PH1, PH2, PH3
- šesthran 1/4" 25 mm PZ1 (2x), PZ2 (3x), PZ3 (2x)
- šesthran 1/4" 25 mm T10, T15, T20, T25, T27, T30
- šesthran 1/4" 25 mm plochý bit 3 x 2, 4 x 2, 4,5 x 2, 6 x 2, 7, 8
- šesthran 1/4" 25 mm šestihran 4, 5, 6, 7
- šesthran 1/4" 50 mm PH1, PH2, PH3
- šesthran 1/4" 50 mm PZ1, PZ2, PZ3
- šesthran 1/4" 50 mm T10, T15, T20, T25, T30, T40
- šesthran 1/4" 50 mm plochý bit 4, 4,5, 7, 8
- šesthran 1/4" 50 mm šestihran 3, 4, 5, 5,5
- šesthran 1/4" nástrčkový ťťahovák 1/4"; 9/32"; 5/16"; 11/32"; 3/8"; 7/16"; 1/2"

objednávacie číslo	cena s DPH
P-30835	46,87 €

# Sady vrtákov a skrutkovacích hrotov

\*\*\*\*

## 102-dielna sada vrtákov/skrutkovacích hrotov



obsah sady  
 vrták hss 1; 1,5; 2; 2,5; 3; 3,2; 3,5; 4; 4,2; 4,5; 5; 5,5; 6  
 vrták do muriva 4; 5,5; 7; 8; 10  
 špirálový vrták do dreva 3; 4; 5; 6; 7; 8  
 plastový doraz bitov 2 ks  
 plastový držiak bitov 2 ks  
 jamkovač  
 šesťhran 1/4" celistvý vrták do dreva 12 mm  
 šesťhran 1/4" celistvý vrták do dreva 16 mm  
 šesťhran 1/4" celistvý vrták do dreva 19 mm  
 šesťhran 1/4" záhlbník  
 šesťhran 1/4" nástrčkový ťahovák vel. 5 / 2 ks  
 šesťhran 1/4" nástrčkový ťahovák vel. 6 / 2 ks  
 šesťhran 1/4" nástrčkový ťahovák vel. 7 / 2 ks  
 šesťhran 1/4" nástrčkový ťahovák vel. 8 / 2 ks  
 šesťhran 1/4" nástrčkový ťahovák vel. 9 / 2 ks  
 šesťhran 1/4" nástrčkový ťahovák vel. 10 / 2 ks  
 šesťhran 1/4" nástrčkový ťahovák vel. 11 / 2 ks  
 šesťhran 1/4" PH0, PH1, PH2, PH3  
 šesťhran 1/4" PZ0 (2x), PZ1 (2x), PZ2 (2x), PZ3 (2x)  
 šesťhran 1/4" 50 mm PH1, PH2, PH3  
 šesťhran 1/4" 50 mm PZ1, PZ2 (2x), PZ3  
 šesťhran 1/4" plochý bit 3, 4, 5, 6  
 šesťhran 1/4" šesťhranný bit 3; 4 (2x); 5; 5,5; 6 (2x); 7 mm  
 šesťhran 1/4" T10, T15, T20, T25, T27, T30, T35 a T40  
 šesťhran 1/4" plochý bit 50 mm 3; 4; 5; 6  
 šesťhran 1/4" šesťhranný bit 50 mm 3; 4; 5  
 rukoväť skrutkovača  
 šesťhran 1/4" rýchlýmenný nástavec  
 vodováha  
 pásmo 3,5 m  
 víťacia korunka (mm) 32; 38; 44; 54  
 adaptér šesťhran 1/4"

objednávacie číslo	cena s DPH
P-52037	56,74 €

## 33 dielna sada bitov a vrtákov

\*\*\*\*



vrtáky do železa: Ø 2 mm (1 ks); Ø 3 mm (2 ks);  
 Ø 3,3 mm (1 ks); Ø 4 mm (1 ks); Ø 4,2 mm (1 ks);  
 Ø 5 mm (1 ks); záhlbníkový vrták (1 ks)  
 vrtáky do tehly a muriva: Ø 4 mm (1 ks); Ø 5 mm (1 ks);  
 Ø 6 mm (1 ks); Ø 7 mm (1 ks); Ø 8 mm (1 ks)  
 vrtáky do dreva: Ø 3 mm (1 ks); Ø 4 mm (1 ks);  
 Ø 5 mm (1 ks); Ø 6 mm (1 ks); Ø 7 mm (1 ks); Ø 8 mm (1 ks)  
 nástrčkové kľúče: Ø 6 mm (1 ks); Ø 8 mm (1 ks);  
 Ø 10 mm (1 ks)  
 bity: PH1 (1 ks); PH2 (1 ks); PH3 (1 ks); PZ1 (1 ks);  
 PZ2 (1 ks); PZ3 (1 ks); S6 (1 ks); S8 (1 ks); T20 (1 ks);  
 T25 (1 ks); držiak bitov (1 ks)

objednávacie číslo	cena s DPH
B-49389	28,44 €



# Sady vrtákov a skrutkovacích hrotov

sada príslušenstva

\*\*\*\*

objednávacie číslo	popis	cena s DPH
P-44046	216 dielna sada príslušenstva	84,52 €



sada vrtákov/skrutkovacích hrotov

\*\*\*\*



objednávacie číslo	obsah	cena s DPH
P-44002	bity: 1 ks PH1; 1 ks PH2 1 ks PH3; 1 ks 3; 1 ks 5 1 ks 6; 1 ks PZ1; 1 ks PZ2; 1 ks PZ3; 1 ks predlžovací nadstavec vrtáky do železa: 1 ks Ø 3; 1 ks Ø 4; 1 ks Ø 5 1 ks Ø 6; 1 ks Ø 8 vrtáky do tehly 1 ks Ø 4; 1 ks Ø 5; 1 ks Ø 6; 1 ks Ø 8 vrtáky do dreva 1 ks Ø 4; 1 ks Ø 5; 1 ks Ø 6,5	12,73 €

# Sady vrtákov a skrutkovacích hrotov

## 28-dielna sada skrutkovacích hrotov



\*\*\*\*

objednávacie číslo	cena s DPH
P-64808	23,93 €

## 49-dielna sada skrutkovacích hrotov



\*\*\*\*

objednávacie číslo	cena s DPH
P-52043	32,69 €

## 37 dielna sada bitov



\*\*\*\*

objednávacie číslo	cena s DPH
B-28606	19,26 €

## 25 dielna sada bitov



\*\*\*\*

objednávacie číslo	cena s DPH
B-49915	37,88 €

25 mm:  
 1× PH1; 2× PH2; 1× PH3  
 1× PZ1; 2× PZ2; 1× PZ3  
 1× T10; 1× T15; 2× T20; 2× T25; 2× T30  
 1× SQ1; 2× SQ2; 1× SQ3

50 mm:  
 1× PH2; 1× PH2; 1× SQ2; 1× T25  
 1× Ultra Mag držiak bitu

# Sady vrtákov a skrutkovacích hrotov

## Sada bitov Makita



objednávacie číslo	ks/bal.	typ	cena s DPH
D-30667-12*	1	plochý 4	123,51 €
	1	plochý 5,5	
	1	plochý 6,5	
	2	PH1	
	4	PH2	
	1	PH3	
	2	PZ1	
	5	PZ2	
	1	PZ3	
	2	T10	
	2	T15	
	2	T20	
	3	T25	
	2	T30	
1	T40		

\*Cena za 12 ks sád

## Sada bitov Makita



objednávacie číslo	ks/bal.	typ	cena s DPH
D-31083-12*	1	PH1	95,95 €
	1	PH2	
	1	PH3	
	1	PZ1	
	1	PZ2	
	1	PZ3	
	1	T10	
	1	T15	
	1	T20	
	1	T25	
	1	T30	
	1	magnetický nadstavec	

\*Cena za 12 ks sád

## Sada bitov Makita



objednávacie číslo	ks/bal.	typ	cena s DPH
D-30651-12*	1	PH1	99,76 €
	1	PH2	
	1	PH3	
	1	PZ1	
	1	PZ2	
	1	PZ3	
	1	T15	
	1	T20	
	1	T25	
	1	T30	
	1	magnetický nadstavec	

\*Cena za 12 ks sád

## Skrutkovač s magnetickým hrotom

\*\*\*\*\*



objednávacie číslo	typ	cena s DPH
B-42438	skrutkovač s magnetickým hrotom PH2x125 mm	18,87 €
B-42444	skrutkovač s magnetickým hrotom PH3x150 mm	21,25 €
B-42450	skrutkovač s magnetickým hrotom PZ2x125 mm	19,91 €
B-42466	skrutkovač s magnetickým hrotom PZ3x150 mm	21,28 €

## Metre



objednávacie číslo	dĺžka (m)	šírka (mm)	magnetická stopka	stupnica na oboch stranách	extra	cena s DPH
B-57168	10	25	☺	☺		31,88 €
B-57152	7,5	25	☺	☺		27,21 €
B-57174	7,5	25	☺	☺	držiak na opasok	72,95 €
B-57130	3,5	16		☺		9,95 €



# Sady bitov v systainery

## 96-dielna sada príslušenstva v systainery



**Bity:**  
 25 mm dĺžka: 2xPH0, 2xPH1, 4xPH2, 2xPH3, 2xPZ0, 2xPZ1, 4xPZ2, 2xPZ3  
 Plochý bit: 2x4, 2x4,5, 2x5,5, 2x6,5  
 Šesthran: 2xH3, 2xH4, 2xH5, 2xH6  
 Torx: 2xTX10, 4xTX15, 4xTX20, 4xTX25, 2xT27, 4xTX30, 2xTX40  
 Torx-TR: 2xST10, 2xST15, 2xST20, 2xST25, 2xST27, 2xST30, 2xST40

**Vrtáky:**  
 HSS: 3 - 4 - 5 - 6 - 8 - 10 mm  
 Drevo: 3 - 4 - 5 - 6 - 8 - 10 mm  
 Kameň: 3 - 4 - 5 - 6 - 8 - 10 mm

objednávacie číslo	cena s DPH
B-49725	145,31 €

## 69-dielna sada príslušenstva v systainery



**Bity:**  
 50 mm dĺžka: 5 x PH2, 5 x PZ2  
 25 mm dĺžka: PH0 PH1 PH2 PH3 PZ0 PZ1 PZ2 PZ3  
 Plochý bit: 4 - 4,5 - 5,5 - 6,5  
 Šesthran: 10, 15, 20, 25, 27, 30, 40, H3, H4, H5, H6  
 Torx: TX10, TX15, TX20, TX25, TX30, TX40  
 Orech 6 hran s upínaním 1/4": 6, 8, 10, 12, 13

**Vrtáky:**  
 HSS-G: 3,0 - 4,0 - 5,0 - 6,0 - 8,0 mm  
 Drevo: 3,0 - 4,0 - 5,0 - 6,0 - 8,0 mm  
 Kameň: 5,0 - 6,0 - 8,0 - 10 mm  
 Plochý vrták do dreva: 16,0 - 20,0 mm

objednávacie číslo	cena s DPH
B-49638	107,55 €

## 66-dielna sada príslušenstva v systainery



**Bity:**  
 50 mm dĺžka: 5 x PH2, 5 x PZ2  
 25 mm dĺžka: 1xPH0 1xPH1 1xPH2 1xPH3 1xPZ0 1xPZ1 1xPZ2 1xPZ3  
 Plochý bit: 4 - 4,5 - 5,5 - 6,5  
 Šesthran: 10, 15, 20, 25, 27, 30, 40 H3, H4, H5, H6  
 Torx: TX10, TX15, TX20, TX25, TX30, TX40  
 Orech 6 hran s upínaním 1/4": 6, 8, 10, 12, 13

**Vrtáky:**  
 HSS: 4,0 - 5,0 - 6,0 - 8,0 - 10,0 mm  
 Drevo: 4,0 - 5,0 - 6,0 - 8,0 - 10,0 mm  
 Plochý vrták do dreva: 16,0 - 20 - 25 mm

objednávacie číslo	cena s DPH
B-43044	104,17 €

## 56 dielna sada príslušenstva v systainery



objednávacie číslo	cena s DPH
B-53768	122,47 €





# Vykružovacie korunky

## BiM vykružovacie korunky

Hliník; Plast; Farebné kovy; Drevo; Tehla



objednávacie číslo	ø (mm)	cena s DPH
B-11265	16	8,32 €
B-31706	17	8,88 €
B-11271	19	7,53 €
B-11287	20	8,80 €
B-11293	22	9,37 €
B-11302	24	9,08 €
B-11318	25	9,91 €
B-31712	27	12,02 €
B-11324	29	11,26 €
B-11330	30	10,30 €
B-11346	32	11,25 €
B-11352	35	12,39 €
B-31728	37	13,27 €
B-11368	38	12,00 €
B-16754	40	14,10 €
B-11374	41	13,26 €
B-11380	44	13,77 €
B-31734	46	15,68 €
B-11396	48	13,16 €
B-11405	51	16,09 €
B-31740	52	16,07 €
B-31756	56	18,13 €
B-11411	57	16,84 €
B-11427	60	16,73 €
B-11433	64	15,77 €
B-16760	65	17,99 €
B-11449	68	17,92 €
B-11455	70	19,36 €
B-31762	73	22,42 €
B-11461	76	19,37 €
B-31778	79	25,19 €
B-11477	83	23,16 €
B-31784	86	24,23 €
B-11483	92	20,62 €
B-11499	102	27,78 €
B-11508	105	28,40 €
B-31809	111	40,19 €
B-31815	114	40,84 €
B-11514	127	43,16 €
B-31837	140	54,62 €
B-11520	152	49,74 €
B-11536	EzyChange adaptér + HSS-G centrovací vrták	27,91 €
B-31902	EzyChange adaptér SDS Plus bez strediaceho vrtáka	33,90 €
B-11542	HSS-G strediaci vrták	7,27 €
B-11966	EzyChange sada vykružovacích korúnok vodárenská 19, 22, 29, 38, 44, 57 mm, adaptér, strediaci vrták	153,23 €
B-11972	EzyChange sada vykružovacích korúnok elektrikárska 16, 20, 25, 32, 40, 51 mm, adaptér, strediaci vrták	114,68 €
B-11988	EzyChange sada vykružovacích korúnok elektrikárska 20, 25, 32, 40, 65 mm, adaptér, strediaci vrták	163,65 €



# Vykružovacie korunky

## BiM vykružovacie korunky

HSS bimetal

Na vŕtanie do ocele, farebných kovov, plastov, dreva a sadrokartónu.



objednávacie číslo	ø (mm)	celková dĺžka (mm)	cena s DPH
D-16994	16	38	2,96 €
D-17005	19	38	3,14 €
D-17251	20	38	3,62 €
D-17011	22	38	3,95 €
D-17027	24	38	4,29 €
D-17033	25	38	4,18 €
D-17267	29	38	4,77 €
D-17049	32	38	5,10 €
D-17055	35	38	5,44 €
D-17061	38	38	5,84 €
D-17273	40	38	5,93 €
D-17077	44	38	6,86 €
D-17083	51	38	7,65 €
D-24876	54	38	8,10 €
D-17099	57	38	8,41 €
D-25688	60	38	8,38 €
D-24882	65	38	9,31 €
D-17108	68	38	9,50 €
D-25694	70	38	9,93 €
D-17114	76	38	10,19 €
D-33869	80	38	12,54 €
D-17120	83	38	11,21 €
D-17136	92	38	13,13 €
D-17142	105	38	14,55 €
D-17158	127	38	18,80 €
D-17164	152	38	20,60 €



objednávacie číslo	popis	cena s DPH
D-17170	adaptér 16–29	3,80 €
D-17186	adaptér 32–152	7,19 €
D-17603	adaptér SDS PLUS 16–29	5,32 €
D-17619	adaptér SDS PLUS 32–152	8,95 €
D-17192	centrovací vrták HSS Ø 6 × 75 mm	2,69 €





# Vykružovacie korunky

## BiM vykružovacie korunky

### Charakteristiky:

- korunka na kruhové otvory, vyrobená zo špeciálne legovanej rýchloreznej ocele
- kombo zuboradie; rozloženie zubov 4-6 zubov/coll
- max. hĺbka rezu je 38 mm
- upínanie náradia: sds-plus alebo šesťhran

### Použitie:

- na nerezovú oceľ väčšej hrúbky ako 1 mm
- na hliník
- na farebné kovy
- na umelé hmoty
- na opracovanie dreva
- na navrtávanie krabíc, pre prestupy káblov a trubiek



objednávacie číslo	ø (mm)	celková dĺžka (mm)	Max. rýchlosť vrtania					cena s DPH
			oceľ	inox	zliatina	meď	hliník	
P-52451	14	38	580	300	400	790	900	6,84 €
P-34936	16	38	550	275	365	730	825	7,75 €
P-52467	17	38	500	250	330	665	750	6,99 €
P-34942	19	38	460	230	300	600	690	7,75 €
P-52473	20	38	440	220	290	580	670	7,02 €
P-52489	21	38	425	210	280	560	630	7,02 €
P-34958	22	38	390	195	260	520	585	8,05 €
P-34964	24	38	370	185	245	495	555	8,28 €
P-34970	25	38	350	175	235	470	525	8,28 €
P-52495	27	38	325	160	215	435	480	7,52 €
P-52504	29	38	300	150	200	400	450	7,82 €
P-52510	30	38	285	145	190	380	425	8,35 €
P-34986	32	38	275	140	180	360	410	9,54 €
P-52526	33	38	368	135	175	345	390	8,35 €
P-34992	35	38	250	125	165	330	375	10,30 €
P-52532	37	38	240	120	160	315	360	9,48 €
P-35003	38	38	240	120	160	315	360	10,80 €
P-52548	40	38	220	110	145	290	330	9,48 €
P-52554	41	38	210	105	140	280	315	10,07 €
P-52560	43	38	205	100	135	270	305	10,07 €
P-35019	44	38	195	95	130	250	295	12,06 €
P-52576	46	38	190	95	125	250	285	10,57 €
P-52582	48	38	180	90	120	240	270	10,57 €
P-35025	51	38	170	85	115	230	255	13,25 €
P-52598	52	38	165	80	110	220	245	11,60 €
P-52607	54	38	160	80	105	210	240	12,72 €
P-35031	57	38	150	75	100	200	225	14,54 €
P-52613	59	38	145	75	100	195	225	12,72 €
P-52629	60	38	140	70	95	190	220	13,02 €
P-52635	64	38	135	65	90	180	205	13,32 €
P-52641	65	38	130	65	85	175	200	13,32 €
P-52657	67	38	130	65	85	170	195	13,85 €
P-35047	68	38	130	65	85	170	195	15,80 €
P-52663	70	38	125	60	80	160	185	14,71 €
P-52679	73	38	120	60	80	160	180	14,71 €
P-35053	76	38	115	55	75	150	170	17,53 €
P-52685	79	38	110	55	70	140	165	16,10 €
P-35069	83	38	105	50	70	140	155	19,02 €
P-52691	86	38	100	50	65	130	150	16,90 €
P-52700	89	38	95	45	65	130	145	17,39 €
P-35075	92	38	95	45	60	120	140	20,81 €
P-52716	95	38	90	45	60	120	135	18,22 €
P-52722	98	38	90	45	60	120	135	19,15 €
P-52738	102	38	85	40	55	110	130	19,91 €
P-35081	105	38	80	40	55	110	120	25,54 €
P-52744	108	38	80	40	55	110	120	23,59 €
P-52750	111	38	80	40	50	100	120	24,54 €
P-52766	114	38	75	35	50	100	105	25,08 €
P-52772	121	38	70	35	45	90	95	27,80 €
P-35097	127	38	65	30	40	85	90	34,59 €
P-52788	140	38	65	30	35	80	85	36,05 €
P-52794	146	38	60	30	35	80	85	40,45 €
P-35106	152	38	55	25	35	75	85	50,13 €

# Vykružovacie korunky

## BiM vykružovacie korunky



objednávacie číslo	ø (mm)	cena s DPH
P-35156	šesťhran 14-30	10,14 €
P-35190	šesťhran 32-152	17,54 €
P-35162	šesťhran 32-152	18,76 €
P-35178	SDS 14-30	17,12 €
P-35184	SDS 32 -152	23,39 €
strediaci vrták		
P-35209	83 mm	5,34 €
P-35215	102 mm	5,54 €

## Sada bi-metalových vykružovacích korúnok



objednávacie číslo	ks/bal.	ø (mm)	cena s DPH
D-33641	1	22	22,68 €
	1	25	
	1	29	
	1	32	

+ 1 ks strediaci vrták s adaptérom

objednávacie číslo	ks/bal.	cena s DPH
D-33641-14	14	243,74 €



objednávacie číslo	ks/bal.	ø (mm)	cena s DPH
D-33657	1	22	29,00 €
	1	29	
	1	32	
	1	51	

+ 2 ks strediaci vrták s adaptérom

# Vykružovacie korunky

## Sada vykružovacích koruniiek vodárensá



objednávacie číslo	ks/bal.	ø (mm)	cena s DPH
D-16938	1	19	49,52 €
	1	22	
	1	29	
	1	38	
	1	44	
	1	57	

## Sada vykružovacích koruniiek elektrikárska



objednávacie číslo	ks/bal.	ø (mm)	cena s DPH
D-16944	1	16	46,47 €
	1	20	
	1	25	
	1	32	
	1	40	
	1	51	



objednávacie číslo	ks/bal.	ø (mm)	cena s DPH
D-24898	1	20	53,42 €
	1	25	
	1	32	
	1	40	
	1	51	
	1	65	

# Vrtáky na kachličky

## Diamantový vrták na kachličky

(vodou chladené)



\*\*\*\*\*

objednávacie číslo	ø (mm)	cena s DPH
P-66569	5	9,06 €
P-66575	6	9,50 €
P-66581	7	14,61 €
P-66597	8	10,28 €
P-66612	10	12,67 €
P-66709	12	13,57 €
P-66715	15	14,86 €
P-66721	20	19,27 €
P-66737	25	18,80 €

## Sada diamantových vrtákov

(vodou chladené)



\*\*\*\*\*

objednávacie číslo	ø (mm)	cena s DPH
P-66628	6, 8, 10	31,59 €
P-66983	15, 20, 25	60,83 €

## Diamantový vykrúžovací vrták na kachličky



\*\*\*\*\*

objednávacie číslo	ø (mm)	cena s DPH
P-70035	19	22,22 €
P-70041	22	25,37 €
P-70057	29	29,50 €
P-70063	35	32,91 €
P-70079	38	33,99 €
P-70085	44	37,49 €
P-70091	57	38,57 €
P-70100	64	54,22 €

## Upínací adaptér pre vykrúžovací vrták



\*\*\*\*\*

objednávacie číslo	ø (mm)	cena s DPH
P-35156	9,6 pre Ø 19-29	10,14 €
P-35162	11 pre Ø 35-64	18,76 €

## Diamantové vrtáky

Na kachličky a dlažbu pre uhlové brúsky  
(vítanie nasucho)



\*\*\*

objednávacie číslo	ø (mm)	cena s DPH
D-35025	M14 × 25mm	24,09 €
D-35019	M14 × 30mm	28,46 €
D-35003	M14 × 35mm	30,44 €
D-37007	M14 × 40mm	36,16 €
D-37013	M14 × 45mm	41,16 €

Maximálny počet otáčok 12 000 min<sup>-1</sup>  
uchytenie M14 pre uhlové brúsky

Diamantový vrták na kachličky, mramor, granit  
(vítanie nasucho)

\*\*\*



objednávacie číslo	ø (mm)	cena s DPH
D-61064	5	13,96 €
D-61070	6	16,14 €
D-61086	8	16,94 €
D-61092	10	17,00 €
D-61101	12	20,67 €
D-44432	14	33,87 €
D-44448	16	37,79 €
D-44454	20	24,40 €
D-44460	22	26,73 €
D-44476	25	30,12 €
D-44482	27	34,42 €
D-44498	30	36,74 €
D-44507	32	36,30 €
D-44513	35	40,91 €
D-44529	38	47,27 €
D-44535	40	50,72 €
D-44541	45	54,24 €
D-44557	51	54,09 €
D-44585	60	68,02 €
D-44600	67	83,41 €
D-44616	68	82,29 €
D-44622	70	88,26 €
D-44638	75	90,70 €
D-44644	80	95,29 €
D-44650	83	87,70 €

Maximálny počet otáčok 12 000 min<sup>-1</sup>  
uchytenie M14 pre uhlové brúsky

# Vykružovacie korunky

Vykružovacie korunky do železa a nehrdzavejúcej ocele

\*\*\*\*\*



objednávacie číslo	ks/bal.	ø (mm)	maximálne otáčky		cena s DPH
			železo	inox	
B-00898	1	16	800–1200	500–700	63,00 €
B-00907	1	18	700–1050	450–600	67,75 €
B-00913	1	20	600–1000	400–550	67,75 €
B-00929	1	21	600–950	350–530	67,75 €
B-00935	1	22	580–800	330–500	67,75 €
B-00941	1	25	500–750	320–450	47,02 €
B-00957	1	27	470–710	300–430	59,37 €
B-00963	1	28	450–680	280–400	74,39 €
B-00979	1	30	430–640	260–370	74,39 €
B-00985	1	32	400–600	240–340	81,59 €
B-00991	1	35	360–550	220–320	85,76 €
B-01002	1	38	430–500	210–300	104,37 €
B-01018	1	40	340–480	200–280	91,87 €
B-01024	1	45	280–430	180–250	116,88 €
B-01030	1	48	260–400	170–230	136,79 €
B-01046	1	50	250–380	160–220	120,14 €
B-01052	1	55	230–350	140–200	152,72 €
B-01177	1	strediaci vrták 6 mm		HSS	11,51 €
B-01199	1	strediaci vrták 6 mm		HM	11,56 €

\*\*\*\*\*

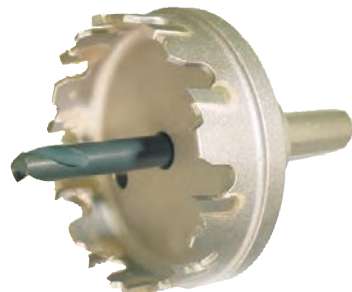

objednávacie číslo	ks/bal.	ø (mm)	maximálne otáčky		cena s DPH
			železo	inox	
B-01068	1	60	210–320	130–190	146,39 €
B-01074	1	65	190–290	120–170	178,14 €
B-02652	1	68	180–280	110–160	198,56 €
B-01080	1	70	180–270	110–160	198,56 €
B-01096	1	75	170–260	100–150	210,77 €
B-01105	1	80	160–240	100–140	223,22 €
B-01111	1	85	150–220	90–130	242,34 €
B-01127	1	90	140–210	90–120	261,69 €
B-01133	1	95	130–200	80–110	270,72 €
B-01149	1	100	130–190	80–110	285,29 €
B-01155	1	110	115–170	70–110	337,94 €
B-01161	1	120	100–160	65–95	399,31 €
B-01183	1	strediaci vrták 8 mm		HSS	19,36 €
B-01208	1	strediaci vrták 8 mm		HM	28,58 €



# Vykružovacie korunky

Diamantové korunky do tehly, porobetónu, kachličiek a mramoru

\*\*\*\*\*



objednávacie číslo	popis	priemer	dĺžka korunky	odporúčané otáčky	cena s DPH
B-45995	diamantová korunka	16	40 mm	3 000 – 5 000 min	20,73 €
B-46006	diamantová korunka	19	40 mm	3 000 – 5 000 min	23,83 €
B-46012	diamantová korunka	25	40 mm	3 000 – 5 000 min	31,99 €
B-46028	diamantová korunka	30	40 mm	3 000 – 5 000 min	38,29 €
B-46034	diamantová korunka	32	40 mm	3 000 – 5 000 min	40,73 €
B-46040	diamantová korunka	35	40 mm	3 000 – 5 000 min	44,55 €
B-46056	diamantová korunka	38	40 mm	3 000 – 5 000 min	48,31 €
B-46062	diamantová korunka	45	40 mm	3 000 – 5 000 min	57,05 €
B-46078	diamantová korunka	50	40 mm	3 000 – 5 000 min	64,56 €
B-46084	diamantová korunka	53	40 mm	3 000 – 5 000 min	67,17 €
B-46090	diamantová korunka	57	40 mm	3 000 – 5 000 min	72,10 €
B-46109	diamantová korunka	64	40 mm	3 000 – 5 000 min	80,88 €
B-53914	diamantová korunka	68	40 mm	3 000 – 5 000 min	86,66 €

objednávacie číslo	popis	priemer	cena s DPH
B-46115	uchytienie s valcovou stopkou 182 mm so strediacim vrtákom 59 mm	182 mm (M12–M6), 59 mm (M6)	13,35 €
B-46137	uchytienie s valcovou stopkou 182 mm	182 mm (M12–M6)	9,37 €
B-46121	strediaci vrták 59 mm	59 mm (M6)	4,77 €
B-52691	uchytienie SDS Plus 182 mm so strediacim vrtákom 59 mm	182 mm (M12–M6), 59 mm (M6)	19,32 €
B-52700	uchytienie SDS Plus 182 mm	182 mm (M12–M6)	15,24 €







# Príslušenstvo k vrtačkám

## Príslušenstvo pre magnetickú vrtačku HB500



objednávacie číslo	popis	priemer (mm)	dĺžka (mm)	cena s DPH
12S	vrtáky HSS	12	30	18,20 €
13S		13	30	18,57 €
14S		14	30	18,74 €
15S		15	30	18,71 €
16S		16	30	19,79 €
17S		17	30	20,91 €
18S		18	30	21,51 €
19S		19	30	22,03 €
20S		20	30	24,69 €
22S		22	30	26,54 €
24S		24	30	27,90 €
26S		26	30	32,93 €
28S		28	30	38,21 €
30S		30	30	39,18 €
32S		32	30	41,97 €
34S		34	30	47,94 €
36S		36	30	51,18 €
38S		38	30	55,92 €
40S		40	30	63,36 €
42S		42	30	66,85 €
44S	44	30	83,49 €	
46S	46	30	79,68 €	
48S	48	30	83,30 €	
50S	50	30	85,38 €	



objednávacie číslo	popis	cena s DPH
PILOTS	strediaci vrták	6,54 €

# Príslušenstvo k vrtačkám

## Skľučovadlá s ozubeným vencom



	objednávacie číslo	rozsah upínania	uchytienie skľučovadla	vhodné pre stroje	cena s DPH
	193318-7	2,0–13		DA4000LR, DA4030	59,58 €
	763174-5	0–10	vreteno	BDA340, BDA350, DA3010F	38,66 €
	192887-5	0,5–6,5	3/8"	6013BR, 6305, 6501/X	11,29 €
	P-04313	1,5–10	3/8"	6412, 6408, 6510LVR	14,91 €
	193822-6	1,5–13	1/2"	HP2050, HP2070, DP4010	26,29 €
	192885-9	1,5–10	vreteno	DA301D	73,85 €
	192877-8	1,5–13	1/2"	8406, 6300-4, 6013B	38,30 €
	P-04329	1,5–13	1/2"	6013B, 6300-4, DP4700, HP1630, HP1640, UT1305	21,44 €
	192883-3	1,0–13	5/8"	DA6301, UT2204	45,73 €
	763250-5	1,5–13		DDA460	32,50 €

## Kľúč ku skľučovadlu



	objednávacie číslo	rozsah upínania	vhodné pre stroje	cena s DPH
	763415-9	10	DA3010	2,32 €
	763418-3	10	6412	0,87 €
	763432-9	13	6305, 6013B/BR, 6300-4, DA4000LR, DA6301, UT1305, UT2204	2,25 €
	763448-4	13	DP4010, HP1620, HP1630, HP1640, HP2050, HP2070	1,18 €
	P-04341	10	6305, 6501/X, 6510LVR	1,04 €

# Príslušenstvo k vrtačkám

## Uhlová súprava

\*\*\*\*\*



objednávacie číslo	popis	vhodné pre stroje	cena s DPH
193317-9	predĺžovacia súprava	DA4000LR	253,16 €
122645-5	hĺbkový doraz	DA4000LR	9,73 €

## Držiak kľúča ku skľučovadlu

\*\*\*\*\*



objednávacie číslo	uchytenie skľučovadla	cena s DPH
410102-8	1/2"	0,25 €
418198-3	3/8"	0,13 €

## Rýchloskľučovadlá

\*\*\*\*\*



objednávacie číslo	rozsah upínania	uchytenie skľučovadla	vhodné pre stroje	cena s DPH
192016-0	0,8–10	3/8"	6408, DA3011F	23,78 €
193924-8	0,8–10	3/8"	6408, 6510LVR, DA3011F	25,93 €
193203-4	0,8–6,5	3/8"	6501/X	39,00 €
193049-8	1,5–13	3/8"	6327D, 6328D	38,49 €
194254-0	1,5–13	1/2"	DP4011, HP2051, HP2071	42,38 €
192685-7	1,5–13	1/2"	6013B/BR, 6300-4, DP4001, DP4003, DP4700, HP1621, HP2051, HP2071	42,83 €
193226-2	1,0–10	1/2"	DP3003	35,70 €
P-15718	1,5–13	1/2"	6013B/BR, 6300-4, DP4001, DP4003, DP4700, HP1621, HP2051, HP2071	35,61 €
763158-3	1,5–13	1/2"	6013B/BR, 6300-4, DP4001, DP4003, DP4700	40,64 €
196193-0	1,5–13	1/2"	6390D, 8390D, HP1621, HP1631, HP1641	24,06 €

# Príslušenstvo k vrtačkám

## Rýchloskľučovadlá



objednávacie číslo	rozsah upínania	uchytenie skľučovadla	vhodné pre stroje	cena s DPH
193601-2	1,0–10	3/8"	6017D, 6018D, 6019D, 6095D, 6096D, DA391D, DA312D	40,51 €
763158-3	1,5–13	1/2"	6390D, 8390D, 6317D, 6337D, 6347D	40,64 €
766009-9	0,8–10	1/2"	8271D, 8281D, DHP343	21,77 €
763178-7	1,5–13	1/2"	6390D, 8390D, 6317D, 6337D, 6347D	29,18 €
763187-6	1,5–10	1/2"	6260D, 6270D, 6280D, 6207D, 8270D, 8280D	16,99 €
763196-5	1,5–13	1/2"	DDF441, DDF451, DHP441, DHP451, DDF444, DDF454, DHP444, DHP454	31,61 €
763199-9	1,5–13	1/2"	6319D, 6339D, 6349D, 8414D, 8434D, 8444D	30,42 €
196309-7	0,8–10	1/2"	6261D, 6271D, 6281D, DDF343,	12,16 €
196310-2	0,8–10	1/2"	8271D, 8281D, DHP343	13,56 €
196306-3	1,5–13	1/2"	6391D, DDF453, DHP453	15,99 €
763228-8	1,5–10	3/8"	BDA341, BDA351, DF330D	6,58 €
763248-2	1,5-13	1/2"-20 UNF	BDF448, DDF448, BHP448, DHP448, BDF458, DDF458, BHP458, DHP458, DHP481, DDF481, DHP482, DHP482	36,60 €
766027-7	1,5–13	1/2"-20 UNF	8413D, BDF450, BDF452, BHP450, BHP452, BDF440, BDF442, BDF446, DDF446, BHP440, BHP442, BHP446, DHP446, BHP456, DHP456, BDF456, DDF456, BDF459, DDF459, BHP459, DHP459, DDF480, DHP480	16,33 €
P-04379	0,8–11	1/4"		28,46 €
122574-2	1–10	SDS-Plus		44,16 €
122829-5		SDS-Max		65,58 €
763229-6	0,8–10	1/2"	HP330	7,29 €

# Príslušenstvo pre vŕtacie skrutkovače a rázové uťahováky

## Kompletná rukoväť pre aku vŕtacie skrutkovače



objednávacie číslo	vhodné pre stroje	cena s DPH
122575-0	DDF460, DHP460, 8413D, 8433D, 8443D	12,37 €
123253-5	DHP441, DHP451	7,40 €
123384-0	DDF444, DDF454	6,66 €
123166-0	DHP444, DHP454	8,06 €

## Híbkové dorazy pre aku vŕtacie skrutkovače



objednávacie číslo	priemer (mm)	dĺžka (mm)	cena s DPH
122576-8	6	250	1,12 €
322223-3	6	250	1,10 €

## Háčiky pre aku vŕtacie skrutkovače



objednávacie číslo	vhodné pre model	cena s DPH
346317-0	BDF444, DDF446, BDF454, DDF456, DDF458, DDF459, DDF480, DDF481, BHP444, DHP446, BHP454, DHP456, DHP458, DHP459, DHP480, DHP481, DTW250, DTW251, DTW280	1,14 €
281217-6	DFR540RFE, DFR550RFE, DFR750RFE	2,28 €
345736-7	BTW450RFE	1,56 €
197941-0	popruh pre náradie 14,4V – 18V Litium-Ion	14,10 €

# Príslušenstvo pre aku kladivá

## Rýchlovýmenné skľučovadlá pre aku kladivá



objednávacie číslo	popis	vhodné pre model	cena s DPH
194079-2	rýchloskľučovadlo 1,5–13 mm	DHR243RFE, DHR261TRDE	62,95 €
194080-7	skľučovadlo SDS-Plus	DHR243RFE, DHR261TRDE	31,62 €

## Kompletná rukoväť pre aku kladivá



objednávacie číslo	vhodné pre model	cena s DPH
158057-6	DHR162, DHR202, DHR241, DHR243, DHR261	3,32 €

## Híbkové dorazy pre aku kladivá



objednávacie číslo	vhodné pre model	priemer (mm)	dĺžka (mm)	cena s DPH
415486-9	DHR162	5	250	1,10 €
324219-0	DHR202, DHR241, DHR243, DHR261	6	220	0,49 €

## HEPA filter DHR243/DHR243



objednávacie číslo	vhodné pre model	cena s DPH
195904-0	hepa odsávanie vhodné pre model DHR243	123,87 €
199572-1	hepa odsávanie vhodné pre model DHR280/282	139,12 €
199579-7	prachovka pre Hepa filter	cena na vyžiadanie
424474-5	filter pre Hepa filter	0,59 €
196165-5	zberná nádoba pre Hepa filter	17,21 €
196163-9		31,63 €

# Príslušenstvo pre aku uhlové skrutkovače

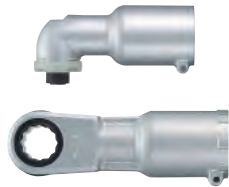

objednávacie číslo	popis	upínanie	vhodné pre model	cena s DPH
135201-2	uhlový adaptér	3/8"	BTL061, BTL062, DTL060, DTL061, DTL062, DTL063, TL064D, TL065D	118,86 €
192439-2	ráčnový adaptér	-	BTL061, BTL062, DTL060, DTL061, DTL062, DTL063, TL064D, TL065D	176,36 €

# Príslušenstvo k vrtačkám

## Rukoväť s uchytím euro 43 mm



objednávacie číslo	vhodné pre stroje	cena s DPH
135302-6	HP1621, HP1630, HP1631	2,85 €

## Jednoduchá rukoväť



objednávacie číslo	vhodné pre stroje	cena s DPH
152892-4	UT1305, UT2204, DA4000LR	9,50 €

## Hĺbkový doraz



objednávacie číslo	ø (mm)	celková dĺžka (mm)	cena s DPH
322177-4	4	125	0,49 €
324219-0	6	220	0,49 €
322223-3	6	250	1,10 €

## Rýchloskľučovadlo s adaptérom SDS-Plus



objednávacie číslo	popis	cena s DPH
122573-4	SDS Plus adaptér pre skľučovadlá (1/2" – 20 UNF)	9,51 €
196193-0	Rýchlo skľučovadlo 13 mm	24,06 €

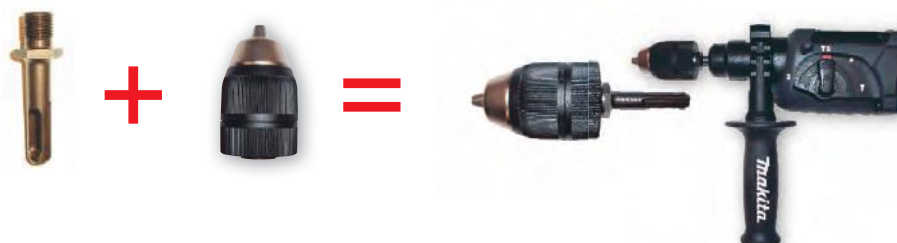



# Miešadlá

\*\*\*\*\*



objednávacie číslo	popis	ø (mm)	celková dĺžka (mm)	množstvo v kg	vhodné pre stroje	cena s DPH
P-02331	kruhovú metlu na miešanie SW8	80	400	10–15	UT120, UT1305*	12,74 €
P-22012	kruhovú metlu na miešanie M14	120	590	15–30	UT1305**, UT2204**	22,13 €
P-02347	špirálovú metlu na miešanie SW8	90	400	7–10	UT1305*, UT2204*	12,35 €
P-22040	špirálovú metlu na miešanie M14	135	590	15–30	UT120, UT2204**	30,21 €
P-02353	zmiešanú metlu na miešanie SW10	100	590	5–15	UT1305*, UT2204*	32,88 €
P-22056	špirálovú metlu na miešanie „negatív“ M14	120	590	15–25	UT120, UT1305**, UT2204**	36,20 €
P-76766	miešadlo M14	100	600	30	UT121	18,87 €

\* iba so skľučovadlom  
\*\* len s adaptérom M14

**Kruhovú miešadlo**  
vyrovnávacie hmoty,  
bitúmenové vrstvy,  
farby, základný adhézný  
náter, náterové tmely,  
zalievacie hmoty

**Špirálovú miešadlo**  
stavebné lepidlá,  
mazaninu, hotovú maltu,  
lepidlo na kachličky,  
škárovaciu hmotu, maltu  
na lepenie obkladov,  
omietky, náterové tmely,  
tepelné izolačné omietky

**Zmiešanú miešadlo**  
vyrovnávacie hmoty,  
stavebné lepidlá,  
betón, mazaninu,  
hotovú maltu, maltu  
na lepenie obkladov,  
nivelačné hmoty,  
všetky druhy malty

**Špirálovú miešadlo „negatív“ M14**  
disperzie, farby,  
vápennosadrovú  
maltu, tepelnú izolačnú  
omietku.  
**Zmiešaný účinok dole**



# Miešadlá

Ďalšie príslušenstvá k miešadlám



objednávacie číslo	popis	upínanie	celková dĺžka (mm)	množstvo v kg	vhodné pre stroje	cena s DPH
165757-1	tanierová metla		165		UT1305	7,49 €
A-43686	tanierová metla		150		UT1305	28,62 €
A-43670	tanierová metla		130		UT1305	13,04 €
265220-5	skrutka na uchytenie metly					5,39 €
A-43751	hriadeľ nerez	M12	560	UT1305	UT120, UT1305*	19,75 €
323962-8	držiak závitovej stopky pre M14 závit			UT1305	UT1305**, UT2204**	8,40 €
324929-9				UT2204	UT1305*, UT2204*	4,44 €
P-22062	adaptér miešadla	1/2" – M14		UT1305	UT120, UT2204**	9,31 €
P-02325		5/8" – M14		UT2204	UT1305*, UT2204*	9,14 €



# Príslušenstvo k vrtačkám

## Diamantové vrtacie korunky na vrtanie nasucho – upínanie M16



Vhodné pre DBM080 a DBM130.



objednávacie číslo	popis	veľkosť (mm)	cena s DPH
P-41997	diamantová vrtacia korunka	68 × 60	168,65 €
P-42008		82 × 60	141,59 €
P-42014		68 × 150	175,24 €
P-42020		76 × 150	255,13 €
P-42036		82 × 150	192,94 €
P-42042		112 × 150	287,23 €
P-42058		132 × 150	251,47 €
P-42064		68 × 400	189,15 €
P-42070		76 × 400	200,57 €
P-42086		82 × 400	228,64 €
P-42092		112 × 400	300,70 €
P-42101		132 × 400	301,52 €

## Príslušenstvo



objednávacie číslo	popis	veľkosť (mm)	cena s DPH
P-41872	odsávací adaptér	M18 × 2,5	151,92 €
P-45082	adaptér	M18–M16	43,28 €
P-41888	vystred'ovacia tyč	60	32,84 €
P-41894		150	27,48 €
P-41903		420	102,23 €
P-41919	kotúč pre vystred'ovaciu tyč	68	3,17 €
P-41931		82	3,97 €
P-41969		112	8,04 €
P-41981		132	9,24 €

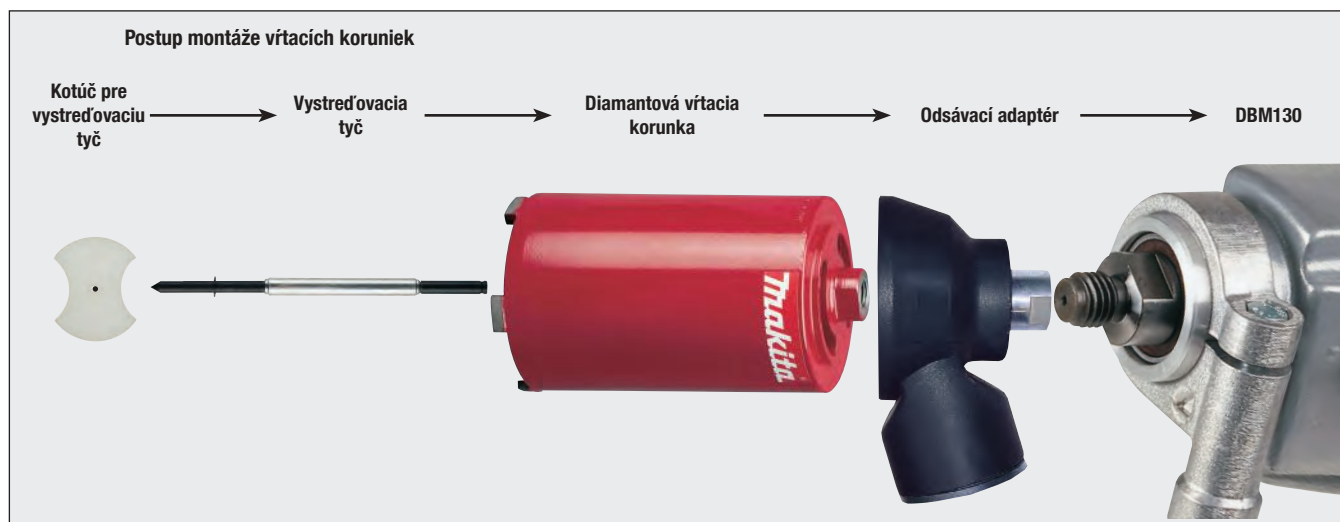



# Príslušenstvo k vrtačkám

## Diamantové jadrové vrtáky na vrtanie namokro

DWS3CR

Vhodný na rezanie: žuly, mramoru, vápenca, bridlice, pevných tehál a iných hustých neabrazívnych materiálov  
Pre použitie s DBM230 nutné dokúpiť adaptér P-41676.

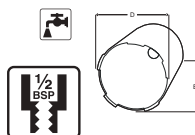

objednávacie číslo	ø (mm)	H (mm)	cena s DPH
P-40733	12	300	88,45 €
P-40749	14	300	90,74 €
P-40755	16	300	91,07 €
P-40761	18	300	91,39 €
P-40777	20	300	91,39 €
P-40783	22	300	94,00 €
P-40799	24	300	96,29 €
P-40808	25	300	97,92 €
P-40814	28	300	101,18 €

DWC4CR

Vhodný na rezanie: betónu, vystuženého betónu, pieskovca, tehál.  
Pre použitie s DBM230 nutné dokúpiť adaptér P-41676.

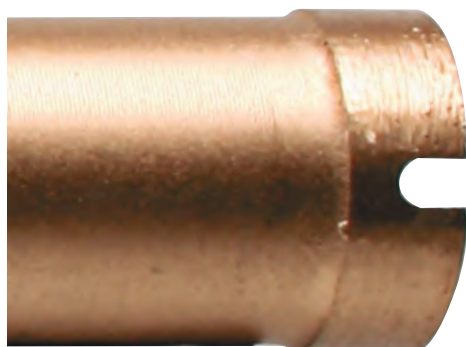
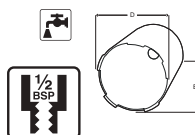

objednávacie číslo	ø (mm)	H (mm)	cena s DPH
P-40842	12	300	88,45 €
P-40858	14	300	90,74 €
P-40864	16	300	91,07 €
P-40870	18	300	91,39 €
P-40886	20	300	91,39 €
P-40892	22	300	94,00 €
P-40901	24	300	96,29 €
P-40917	25	300	97,92 €
P-40923	28	300	101,18 €
P-40939	30	300	104,45 €
P-40945	32	300	114,24 €
P-40973	36	300	124,03 €
P-40989	38	300	133,82 €
P-40995	40	300	137,09 €
P-41006	52	300	153,41 €



# Príslušenstvo k vrtačkám

## Diamantové jadrové vrtáky na vrtanie namokro

DWC4

Vhodný na rezanie: tvrdého betónu, vystuženého betónu.

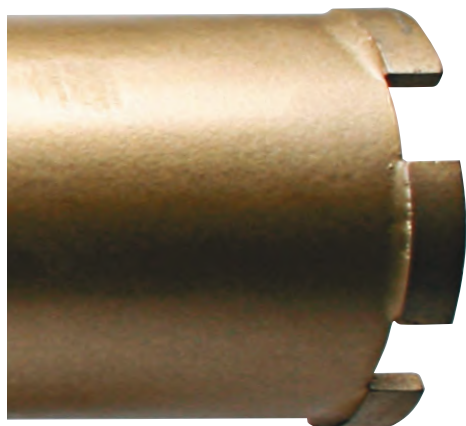
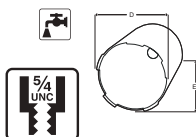

objednávacie číslo	ø (mm)	H (mm)	cena s DPH
P-65816	62	400	156,67 €
P-41034	65	400	159,94 €
P-41056	78	400	189,31 €
P-41078	82	400	192,58 €
P-41090	92	400	212,16 €
P-41115	102	400	231,74 €
P-41137	107	400	251,33 €
P-41143	112	400	257,86 €
P-41159	117	400	264,38 €
P-65822	122	400	267,65 €
P-41165	127	400	297,02 €
P-65838	132	400	306,82 €
P-41171	152	400	329,66 €
P-41187	162	400	365,57 €
P-41193	178	400	376,76 €
P-41202	182	400	382,34 €
P-41218	202	400	405,68 €
P-41224	212	400	452,29 €
P-41230	225	400	503,60 €
P-41246	252	400	540,88 €

DWC7

Vhodný na rezanie: betónu so stredne tvrdými až mäkkými zmesami.

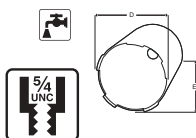

objednávacie číslo	ø (mm)	H (mm)	cena s DPH
P-41305	52	400	133,82 €
P-65844	62	400	156,67 €
P-41333	65	400	159,94 €
P-41355	78	400	189,31 €
P-41377	82	400	192,58 €
P-41399	92	400	212,16 €
P-41414	102	400	231,74 €
P-41436	107	400	251,33 €
P-41442	112	400	257,86 €
P-41458	117	400	264,38 €
P-65850	122	400	267,65 €
P-41464	127	400	297,02 €
P-65866	132	400	306,82 €
P-41470	152	400	329,66 €
P-41486	162	400	365,57 €
P-41492	178	400	376,76 €
P-41501	182	400	382,34 €
P-41517	202	400	405,68 €
P-41523	212	400	452,30 €
P-41539	225	400	503,59 €
P-41545	252	400	540,89 €



# Príslušenstvo pre diamantové vrtačky

## Šesthranná predlžovacia tyč z ocele

5/4" UNC na 5/4" UNC



objednávacie číslo	dĺžka (mm)	cena s DPH
P-41610	200	39,73 €
P-41626	300	89,11 €
P-41632	400	65,09 €
P-41648	500	119,89 €

## Príruba pre vrtačky so „závitom“



objednávacie číslo	popis	cena s DPH
P-41654	príruba s 3 otvormi 5/4" UNC	46,35 €
P-41660	príruba so 6 otvormi 5/4" UNC	56,28 €

## Príruba pre vrtačky so „závitom“

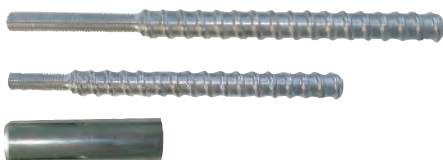

objednávacie číslo	popis	cena s DPH
P-41735	tyč so závitom, 250 mm	14,04 €
P-41729	tyč so závitom, 200 mm	26,11 €
P-41741	kotviaca (zatíková) hmoždinka (M12)	2,28 €

## Sada upevňovacích kotiev



objednávacie číslo	popis	cena s DPH
P-40098	sada kotiev	32,64 €



# Príslušenstvo pre diamantové vrtačky

## Valcový predlžovací nástavec

Vonkajší 1/2" BSP na vnútorný 1/2" BSP



objednávacie číslo	dĺžka (mm)	cena s DPH
P-41551	100	24,48 €

## Adaptéry



objednávacie číslo	opis	cena s DPH
P-41676	vonkajší 5/4" UNC na vonkajší 1/2" BSP	56,01 €
P-41682	vnútorný 1/2" BSP na vnútorný 5/4" UNC	52,97 €
P-41698	vnútorný 1/2" BSP na vnútorný 1/2" BSP	39,73 €
P-41707	hl na vonkajší 1/2" BSP	46,35 €
P-14009	vnútorný 5/4" UNC na M16 vonkajší	49,38 €
P-42151	vnútorný M18 na vonkajší 5/4"/vnútorný 1/2"	31,01 €

## Stojan jadrovej vrtačky DBM230/131



objednávacie číslo	popis	cena s DPH
P-54190	Stojan jadrovej vrtačky DBM230	1 294,34 €
P-40082	Stojan jadrovej vrtačky DBM131	706,00 €

## Odsávacie adaptéry



objednávacie číslo	popis	cena s DPH
P-54178	odsávací adaptér DBM230	262,23 €
P-54184	náhradná guma pre odsávací adaptér DBM230	27,42 €
P-54221	vákuový set	97,50 €





# Príslušenstvo pre DBM131

korunky na vrtanie nasucho



korunky na vrtanie namokro Ø12 – Ø32  
Vrtanie bez armovania  
Diamantový jadrový vrták typu DWS3CR

Objedn. číslo	Priemer	cena EUR s DPH
P-40733	12	88,45 €
P-40749	14	90,74 €
P-40755	16	91,07 €
P-40761	18	91,39 €
P-40777	20	91,39 €
P-40783	22	94,00 €
P-40799	24	96,29 €
P-40808	25	97,92 €
P-40814	28	101,18 €
P-40820	30	104,45 €
P-40836	32	114,24 €

korunky na vrtanie namokro Ø62 – Ø132  
Vrtanie s armovaním  
Diamantový jadrový vrták typu DWC4

Objedn. číslo	Priemer	cena EUR s DPH
P-65816	62	156,67 €
P-41034	65	159,94 €
P-41056	78	189,31 €
P-41078	82	192,58 €
P-41090	92	212,16 €
P-41115	102	231,74 €
P-41137	107	251,33 €
P-41143	112	257,86 €
P-41159	117	264,38 €
P-65822	122	267,65 €
P-41165	127	297,02 €
P-65838	132	306,82 €

Vrtanie bez armovania

Objedn. číslo	veľkosť	cena EUR s DPH
P-41997	68x60	167,86 €
P-42008	82x60	186,38 €
P-42014	68x150	174,43 €
P-42020	76x150	191,74 €
P-42036	82x150	192,05 €
P-42042	112x150	222,15 €
P-42058	132x150	251,47 €
P-42064	68x400	212,37 €
P-42070	76x400	200,57 €
P-42086	82x400	204,02 €
P-42092	112x400	288,85 €
P-42101	132x400	275,72 €

Vrtanie s armovaním  
Diamantový jadrový vrták typu DWC4CR

Objedn. číslo	priemer	cena EUR s DPH
P-40842	12	88,45 €
P-40858	14	90,74 €
P-40864	16	91,07 €
P-40870	18	91,39 €
P-40886	20	91,39 €
P-40892	22	94,00 €
P-40901	24	96,29 €
P-40917	25	97,92 €
P-40923	28	101,18 €
P-40939	30	104,45 €
P-40945	32	114,24 €
P-40973	36	124,03 €
P-40989	38	133,82 €
P-40995	40	137,09 €
P-41006	52	153,41 €

Vrtanie bez armovania  
Diamantový jadrový vrták typu DWC7

Objedn. číslo	Priemer	cena EUR s DPH
P-65844	62	156,67 €
P-41333	65	159,94 €
P-41355	78	189,31 €
P-41377	82	192,58 €
P-41399	92	212,16 €
P-41414	102	231,74 €
P-41436	107	251,33 €
P-41442	112	257,86 €
P-41458	117	264,38 €
P-65850	122	267,65 €
P-41464	127	297,02 €
P-65866	132	306,82 €



M18

Objedn. číslo	cena EUR s DPH
P-45082	43,28 €
P-42151	31,01 €
P-41676	56,01 €



P-45082

P-42151

P-41676

# Skrutkovače

## Skrutkovacie hroty Krížové „PH“



	objednávacie číslo	popis	celková dĺžka (mm)	ks/bal.	cena s DPH
Štandard	P-47933	PH1	25	5	3,36 €
	P-48402	PH1	50	5	4,24 €
	P-47949	PH2	25	5	3,36 €
	P-47949-100	PH2	25	100	30,44 €
	P-48418	PH2	50	5	4,24 €
	P-47955	PH3	25	5	3,36 €
	P-48424	PH3	50	5	4,24 €
PROFI	P-47874	PH1	25	5	3,85 €
	P-48234	PH1	50	5	11,13 €
	P-48240	PH1	89	5	16,22 €
	P-47880	PH2	25	5	3,85 €
	P-47880-50	PH2	25	50	20,14 €
	P-47880-100	PH2	25	100	38,97 €
	P-48256	PH2	50	5	11,13 €
	P-48262	PH2	89	5	16,22 €
	P-48278	PH2	127	5	17,66 €
	P-48315	PH2	141	5	20,30 €
	P-47896	PH3	25	5	3,72 €
	P-48284	PH3	50	5	11,13 €
	P-48290	PH3	89	5	16,22 €
TITAN	P-47994	PH1	25	5	6,70 €
	P-48468	PH1	50	5	8,13 €
	P-48000	PH2	25	5	6,53 €
	P-48474	PH2	50	5	8,13 €
	P-48480	PH3	50	5	8,13 €

## Skrutkovacie hroty Krížové „PZ“



	objednávacie číslo	popis	celková dĺžka (mm)	ks/bal.	cena s DPH
Štandard	P-47961	PZ1	25	5	3,36 €
	P-48430	PZ1	50	5	4,24 €
	P-47977	PZ2	25	5	3,36 €
	P-47977-50	PZ2	25	50	15,47 €
	P-47977-100	PZ2	25	100	30,75 €
	P-48446	PZ2	50	5	4,24 €
	P-47983	PZ3	25	5	3,36 €
	P-48452	PZ3	50	5	4,24 €
	P-47905	PZ1	25	5	3,72 €
	P-48321	PZ1	50	5	11,13 €
	P-48337	PZ1	89	5	16,22 €
	P-47911	PZ2	25	5	3,72 €
	PROFI	P-47911-50	PZ2	25	50
P-47911-100		PZ2	25	100	39,30 €
P-48343		PZ2	50	5	11,13 €
P-48359		PZ2	89	5	16,22 €
P-48365		PZ2	127	5	17,66 €
P-47927		PZ3	25	5	3,72 €
TITAN	P-48371	PZ3	50	5	11,13 €
	P-48022	PZ1	25	5	6,53 €
	P-48038	PZ2	25	5	6,53 €
	P-48505	PZ2	50	5	8,13 €
	P-48044	PZ3	25	5	6,53 €
P-48511	PZ3	50	5	8,13 €	

# Skrutkovače

## Skrutkovacie hroty TORX



	objednávacie číslo	popis	celková dĺžka (mm)	ks/bal.	cena s DPH	
PROFI	P-48050	T8	25	5	5,12 €	
	P-48527	T8	50	5	5,65 €	
	P-48066	T9	25	5	5,12 €	
	P-48533	T9	50	5	5,65 €	
	P-48072	T10	25	5	5,12 €	
	P-48549	T10	50	5	5,48 €	
	P-48088	T15	25	5	5,12 €	
	P-48555	T15	50	5	5,48 €	
	P-48094	T20	25	5	5,12 €	
	P-48561	T20	50	5	5,48 €	
	P-48103	T25	25	5	5,12 €	
	P-48577	T25	50	5	5,48 €	
	P-48119	T27	25	5	5,12 €	
	P-48583	T27	50	5	5,48 €	
	P-48125	T30	25	5	5,12 €	
	P-48599	T30	50	5	5,48 €	
	P-48131	T40	25	5	5,12 €	
	P-48608	T40	50	5	5,48 €	
	TITAN	P-48147	T8	25	5	8,51 €
		P-48614	T8	50	5	9,14 €
P-48153		T9	25	5	8,51 €	
P-48620		T9	50	5	9,14 €	
P-48169		T10	25	5	8,29 €	
P-48636		T10	50	5	8,68 €	
P-48642		T15	50	5	8,68 €	
P-48181		T20	25	5	8,29 €	
P-48658		T20	50	5	8,68 €	
P-48197		T25	25	5	8,29 €	
P-48664		T25	50	5	8,68 €	
P-48670		T27	50	5	8,68 €	
P-48212		T30	25	5	8,29 €	
P-48686		T30	50	5	9,00 €	
P-48228		T40	25	5	8,29 €	
P-48692		T40	50	5	8,92 €	

# Skrutkovače

## Nástrčkový bit



objednávacie číslo	popis	celková dĺžka (mm)	ks/bal.	cena s DPH
P-48723	5,5	50	1	5,29 €
P-48739	6	50	1	5,29 €
P-48745	7	50	1	6,17 €
P-48751	8	50	1	6,17 €
P-48767	9	50	1	6,17 €
P-48773	10	50	1	6,89 €
P-48789	10	65	1	7,93 €
P-48795	13	50	1	7,61 €
P-48804	13	65	1	8,65 €
P-48810	17	50	1	10,05 €
P-48826	17	65	1	10,58 €

## Nástrčkový bit s magnetom



objednávacie číslo	popis	celková dĺžka (mm)	ks/bal.	cena s DPH
P-06018	3/8"	65	1	10,16 €
P-06024	5/16"	65	1	8,85 €
P-05991	1/4"	65	1	8,48 €
P-48854	7	50	1	10,41 €
P-48860	8	50	1	10,41 €
P-48876	10	50	1	11,13 €
P-48882	10	65	1	12,17 €
P-48898	13	50	1	11,82 €

## Magnetický nádstavec



objednávacie číslo	upínanie	celková dĺžka (mm)	ks/bal.	cena s DPH
P-49018	1/4"	60	1	6,53 €
B-52445	1/4"	60	1	2,84 €
P-49024	1/4"	75	1	8,13 €
B-57750	1/4"	150	1	4,95 €
B-57766	1/4"	300	1	7,01 €

## 80 mm magnetický držiak bitov



objednávacie číslo	ks/bal.	cena s DPH
B-48751	1	2,94 €

# Skrutkovače



## Torx 25 mm



objednávacie číslo	rozmer	ks/bal	cena s DPH
B-28391	T10	2	3,58 €
B-28400	T15	2	3,52 €
B-28416	T20	2	3,46 €
B-28422	T25	2	3,58 €
B-28438	T30	2	3,44 €

## PZ 25 mm



objednávacie číslo	rozmer	ks/bal	cena s DPH
B-28444	PZ1	2	3,46 €
B-28450	PZ2	2	3,49 €
B-28466	PZ3	2	3,51 €

## PH 25 mm



objednávacie číslo	rozmer	ks/bal	cena s DPH
B-28329	PH1	2	3,30 €
B-28335	PH2	2	3,46 €
B-28341	PH3	2	2,81 €

## PH 25mm Special



objednávacie číslo	popis	rozmer	ks/bal	cena s DPH
B-28488	pre skrutky do dreva	PH2	2	4,23 €
B-28503	pre skrutky do kovu	PH2	2	3,82 €

# Skrutkovače

## Torx 50 mm



objednávacie číslo	rozmer	ks/bal	cena s DPH
B-28226	T10	2	5,80 €
B-28232	T15	2	5,50 €
B-28248	T20	2	5,64 €
B-28254	T25	2	5,44 €
B-28260	T30	2	5,46 €

## PZ 50 mm



objednávacie číslo	rozmer	ks/bal	cena s DPH
B-28276	PZ1	2	4,61 €
B-39182	PZ2	2	5,02 €
B-28298	PZ3	2	5,16 €

## PH 50 mm



objednávacie číslo	rozmer	ks/bal	cena s DPH
B-28167	PH1	2	5,43 €
B-39160	PH2	2	5,08 €
B-28189	PH3	2	5,21 €

## PH 50 mm Special



objednávacie číslo	popis	rozmer	ks/bal	cena s DPH
B-28307	pre skrutky do dreva	PH2	2	6,10 €
B-28313	pre skrutky do kovu	PH2	2	5,88 €

PH Special

Pre skrutky do kovu

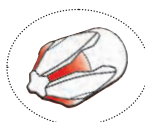

Pre skrutky do dreva

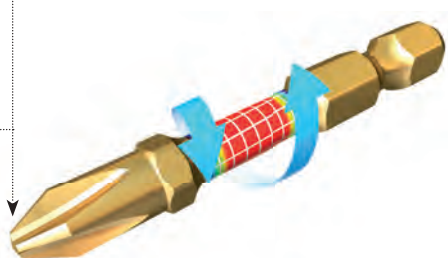
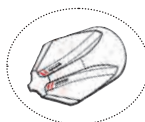

**10x**  
dlhšia životnosť

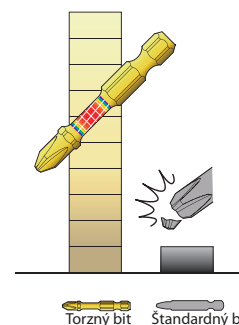

Torzný bit      Štandardný bit

# Skrutkovače

## Držiak bitu



objednávacie číslo	popis	dĺžka (mm)	ks/bal	cena s DPH
B-28525	torzný držiak bitu	75	2	7,16 €

## Nástrčkový bit



objednávacie číslo	rozmer	dĺžka (mm)	ks/bal	cena s DPH
B-28569	8	50	1	5,92 €
B-28575	3/8"	50	1	5,88 €
B-28581	10	50	1	5,91 €

## Adaptér



objednávacie číslo	popis	dĺžka (mm)	cena s DPH
B-28553	z 1/4" na 1/2"		5,54 €
B-28547	z 1/4" na 3/8"		5,34 €
B-54667	z 1/4" na 3/8"	50	2,09 €
B-54673	z 1/4" na 1/2"	50	2,77 €
B-57738	z 1/4" na 3/8"	150	6,33 €
B-57744	z 1/4" na 1/2"	150	8,42 €

## Držiak bitu



objednávacie číslo	popis	dĺžka (mm)	ks/bal	cena s DPH
B-28531	Ultra-Mag torzný držiak bitu	71	1	8,32 €

## Nadstavec na sádrokartónárske skrutky PH2



objednávacie číslo	popis	dĺžka (mm)	ks/bal	cena s DPH
D-61690	upínanie 1/4"	30	1	4,30 €



# Skrutkovače

## Sada torzných bitov



objednávacie číslo	popis	rozmer	ks/bal	cena s DPH
B-28597	11 ks sada torzných bitov	PH1, PH2, PH3, PZ1, PZ2, PZ3, T15, T20, T25, T30 1x torzný držiak bitu	1	22,98 €
B-30754	11 ks sada torzných bitov	PH1, PH2, PH3, PZ1, PZ2, PZ3, T15, T20, T25, T30 1x torzný držiak bitu ULTRA MAG	1	24,38 €

## Nadstavce na zakrúcanie závitových tyčí s upínaním 1/4"

\*\*\*\*\*



objednávacie číslo	rozmer (mm)	cena s DPH
B-42961	6	18,37 €
B-42977	8	19,37 €
B-42983	10	20,37 €
B-42999	6, 8, 10 (sada)	41,93 €

## 5-dielna sada nástrčkových kľúčov s 1/4" upínaním



objednávacie číslo	popis	cena s DPH
B-39154	SW 6, 8, 10, 12, 13	5,88 €

## Obojstranné magnetické bity

\*\*\*



objednávacie číslo	popis	ks/bal.	cena s DPH
D-34914	PZ2 / 65 mm	100	48,57 €
D-31669	PH2 / 65 mm	100	55,60 €

# Skrutkovače

## Ohybný hriadeľ so skrutkovacou čepelou

\*\*\*\*\*



objednávacie číslo	dĺžka (mm)	cena s DPH
B-29072	200	5,30 €
B-29094	300	6,99 €

## Profesionálne sady bitov

\*\*\*\*\*



objednávacie číslo	obsah	cena s DPH
P-54053	1 × PH1; 1 × PH2; 1 × PH3; 1 × PZ1; 1 × PZ2; 1 × PZ3; 1 × T15; 1 × T20; 1 × T25; 1 × T30; 1 × magnetický nadstavec	11,66 €
P-53768	1 × T7; 1 × T8; 1 × T9; 1 × T10; 1 × T15; 1 × T20; 1 × T25; 1 × T27; 1 × T30; 1 × T40; 1 × magnetický nadstavec	17,91 €
P-53724	1 × 5,5; 1 × 6,5; 1 × PH1; 2 × PH2; 1 × PH3; 1 × PZ1; 2 × PZ2; 1 × PZ3; 1 × magnetický nadstavec	14,87 €



objednávacie číslo	obsah	cena s DPH
B-48773	5 × PH2 25 mm; 5 × PZ2 25 mm; 5 × T20 25 mm; 5 × T25 25 mm; 5 × T30 25 mm; 1 × 80 mm magnetický držiak bitov	13,38 €

# Skrutkovače

## Profesionálne sady bitov



objednávacie číslo	obsah	cena s DPH
P-73374	2ks PH1; 4ks PH2; 2ks PH3; 2ks PZ1; 4ks PZ2; 2ks PZ3; 1ks T8; 2ks T10; 2ks T15; 2ks T20; 3ks T25; 1ks T27; 2ks T30; 1ks T40; 1ks nadstavec	10,99 €
P-49030	1ks 3,5; 1ks 5,5; 1ks PH1; 2ks PH2; 1ks PH3; 1ks PZ1; 2ks PZ2; 1ks PZ3; 1ks magnetický nadstavec	11,20 €
P-49046	1ks 3,5; 1ks 5,5; 1ks PH1; 2ks PH2; 1ks PH3; 1ks PZ1; 2ks PZ2; 1ks PZ3; 1ks magnetický nadstavec	17,50 €
P-70144	2x5,5 / 2x6,5; 6xPH1; 12xPH2; 4xPH3; 2xPZ0; 6xPZ1; 12xPZ2; 2xPZ3; 2x T10, T15, T20; 2x T25, T30, T40;	32,55 €
P-70166	10 dielna sada bitov Torzný bit PH 1, 2, 3 Torzný bit PZ 1, 2, 3 Torx T15, 20, 25, 30	10,73 €
D-30667-12	plochý 4 (1 ks); plochý 5,5 (1 ks); plochý 6,5 (1 ks); PH1 (2 ks); PH2 (4 ks); PH3 (1 ks); PZ1 (2 ks); PZ2 (5 ks); PZ3 (1 ks); T10 (2 ks); T15 (2 ks); T20 (2 ks); T25 (3 ks); T30 (2 ks); T40 (1 ks)	123,51 € (balenie 12ks)
D-31083 -12	PH1; PH2; PH3; PZ1; PZ2; PZ3; T10; T15; T20; T25; T30; magnetický nadstavec	97,31 € (balenie 12ks)

## Torzne hroty pre rázové skrutkovače

Nová generácia hrotov pre skrutkovače, ktoré sú ideálne pre dlhodobé skrutkovanie vysokým krútiacim momentom s elektrickými a akku skrutkovačmi. Zúžená stredná časť absorbuje nadmerný krútiaci moment vlastným otáčaním.

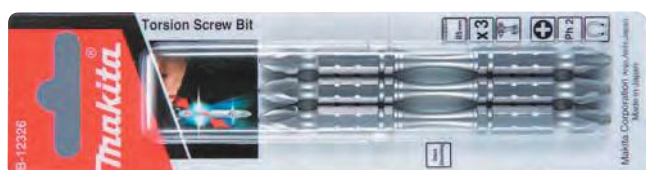

objednávacie číslo	opis	celková dĺžka (mm)	ks/bal.	cena s DPH
B-12326	PH2	85	3	9,84 €
B-12790	PZ2	85	3	10,93 €

# Skrutkovače

## Profesionálne bity



objednávacie číslo	popis	dĺžka (mm)	ks/bal.	cena s DPH
P-06052	PH2	25	10ks	5,62 €
P-06111	PZ2	25	10KS	5,62 €
P-06389	TORX TX40	25	10ks	8,70 €
P-53344	PH2	25	3ks	2,53 €
P-53475	PZ2	25	3ks	2,53 €

## Príslušenstvo s upnutím šesťhran 1/4" na skrutkovače so zásobníkom



objednávacie číslo	vhodné pre stroj	dĺžka (mm)	typ	ks/bal.	cena s DPH
P-67795	6842, 6843, DFR540, DFR550	157	PH2	3	13,04 €
P-67804	6844, DFR780	177	PH2	3	14,65 €



objednávacie číslo	pre model	cena s DPH
194280-9	DTD130, BTD130, DTD133, BTD133, DTD134, BTD134, DTD136, DTD137, BTD136, DTD140, BTD140, DTD141, DTD146, BTD146, DTD147, BTD147, DTD148, DTD152, DTP130, BTP132, DTP140, BTP140, DTP141, BTP141, DTD152, DTS130, BTS130, 6980FD, TD0101F	33,75 €

## Predĺženie rukoväti

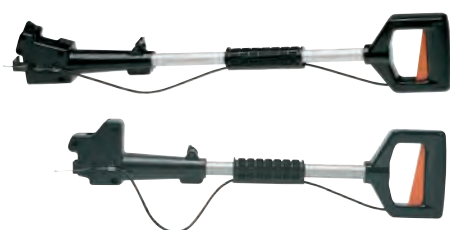

objednávacie číslo	popis	cena s DPH
192501-3	teleskopický predĺžovací nástavec (predĺženie 60–70 cm) 6830/6832/6833/6834	65,36 €
194500-1	6840 / 6841 / 6841R/ 6842 / 6843 / 6844 / 6845 / DFR440/540/550/750	89,94 €

# Páskované skrutky pre skrutkovače so zásobníkom

## Skrutky do sadrokartónu upevneného do kovovej konštrukcie



obj. číslo	názov	ø (mm)	dĺžka (mm)	povrchová úprava	ks/bal.	cena s DPH
P-04117	páskované šrouby	3,9	25	fosfátované	1000	30,36 €
P-31712	páskované šrouby	3,9	30	fosfátované	1000	30,68 €
P-04123	páskované šrouby	3,9	35	fosfátované	1000	33,13 €
P-31463	páskované šrouby	3,9	40	fosfátované	1000	40,31 €
P-31479	páskované šrouby	3,9	45	fosfátované	1000	41,29 €

## Skrutky do sadrokartónu upevneného do dreva



obj. číslo	názov	ø (mm)	dĺžka (mm)	povrchová úprava	ks/bal.	cena s DPH
P-35221	páskované šrouby	3,9	30	fosfátované	1000	31,17 €
P-24832	páskované šrouby	3,9	35	fosfátované	1000	32,64 €
P-04139	páskované šrouby	3,9	41	fosfátované	1000	35,58 €
P-13546	páskované šrouby	3,9	55	fosfátované	1000	40,64 €

## Skrutky pre dosky typu Fermacell upevnené do kovovej konštrukcie



obj. číslo	názov	ø (mm)	dĺžka (mm)	povrchová úprava	ks/bal.	cena s DPH
P-04145	páskované šrouby	3,9	30	fosfátované	1000	43,74 €
P-31382	páskované šrouby	3,9	45	fosfátované	1000	44,06 €

# Páskované skrutky pre skrutkovače so zásobníkom

## Stavebné skrutky do dreva



obj. číslo	názov	ø (mm)	dĺžka (mm)	povrchová úprava	ks/bal.	cena s DPH
P-04167	páskované stavebné šrouby	4,2	41	pozinkované	1000	43,25 €
P-13530	páskované stavebné šrouby	4,2	55	pozinkované	1000	51,24 €

## Stavebné rýchloskrutky TEXS vhodné pre všetky materiály



obj. číslo	názov	ø (mm)	dĺžka (mm)	povrchová úprava	ks/bal.	cena s DPH
P-04151	páskované šrouby TEXS	3,9	35	fosfátované	1000	34,11 €

## Stavebné rýchloskrutky pre trieskové a OSB dosky



obj. číslo	názov	ø (mm)	dĺžka (mm)	povrchová úprava	ks/bal.	cena s DPH
P-31413	páskované stavebné rýchlošrouby	4,0	35	biely zinok	1000	37,70 €
P-31429	páskované stavebné rýchlošrouby	4,0	40	biely zinok	1000	42,11 €
P-13225	páskované stavebné rýchlošrouby	4,5	75	biely zinok	500	73,28 €

# Použitie skrutkovačov

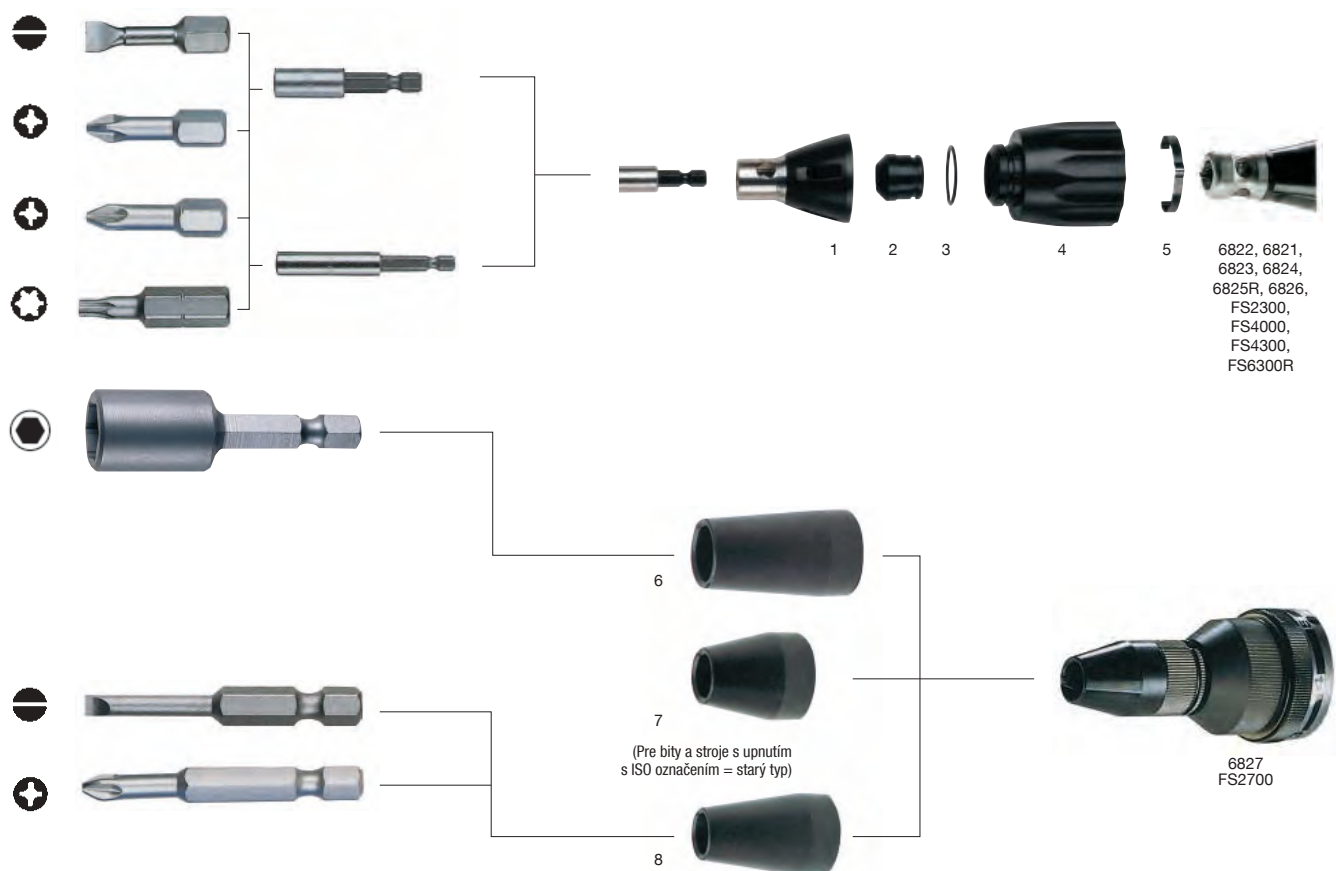

\*\*\*\*\*

objednávacie číslo	obr. č.	popis	Ø	ks/bal.	cena s DPH
151561-4	1	vodiace puzdro		1	6822 10,18 €
151760-8	1	vodiace puzdro		1	6823, 6824, 6825R 2,41 €
152483-1	1	vodiace puzdro	1/4"	1	6821, 6826 2,50 €
152823-3	1	vodiace puzdro	3/8"	1	6821, 6826 5,23 €
158875-2	1	vodiace puzdro		1	FS2300, FS4000, FS4300, FS6300R 4,44 €
421631-6	2	tesniaci krúžok		1	6822, 6823, 6824, 6825R 0,54 €
424163-2	2	tesniaci krúžok		1	FS2300, FS4000, FS4300, FS6300R 0,16 €
421519-0	2	prachovka		1	6821 0,67 €
421775-2	2	prachovka		1	6826 0,55 €
213953-6	3	o-krúžok 22		1	6821, 6822, 6823, 6824, 6825R, 6826 0,34 €
424235-3	3	o-krúžok		1	FS2300, FS4000, FS4300, FS6300R 0,10 €
416756-9	4	nastavovacie puzdro		1	6822 3,98 €
455428-1	4	nastavovacie puzdro		1	6823, 6824, 6825R, 6827 1,14 €
415570-0	4	nastavovacie puzdro		1	6821 1,34 €
455591-0	4	nastavovacie puzdro		1	FS2300, FS4000, FS4300, FS6300R 2,08 €
232154-7	5	pružina		1	6822, 6823, 6824, 6825R, 6826, 6821 0,91 €
232245-4	5	pružina		1	FS2300, FS4000, FS4300, FS6300R 1,29 €
234266-2	5	pružina		1	FS2300, FS4000, FS4300, FS6300R 0,86 €
455428-1	4	nastavovacie puzdro		1	6823, 6824, 6825R, 6827 1,14 €
322069-7	6	vodiace puzdro	15	45	1 6827, FS2700 8,85 €
322070-2	7	vodiace puzdro	12	45	1 6827, FS2700 7,31 €
322120-3	8	vodiace puzdro	12	50	1 6827, FS2700 3,16 €
134873-0		adaptér		1	6821, 6822, 6823, 6824, 6825R, 6826, 6827 40,23 €



# Príslušenstvo pre rázové uťahováky \*\*\*\*\*



objednávacie číslo	popis	upínanie	dĺžka (mm)	ks/bal.	cena s DPH
134874-8		1/2"	100	1	27,11 €
134997-2	predĺženie	3/4"	150	1	40,58 €
134870-6		1"	200	1	111,13 €
134877-2	kľobový adaptér	1/2"	84	1	84,20 €
134998-0		3/4"	84	1	103,68 €
134873-0	redukcia na 1/4"	1/2"		1	40,23 €
P-05941	rýchlovýmenný držiak na 1/4"	1/2"		1	33,63 €
P-21559	krúžok k P-05941			1	2,20 €
P-21565	čap k P-05941			1	0,83 €
B-55728		1/2"	75		5,15 €
B-55712	predĺžovací nadstavec pre 1/2" rázové uťahováky	1/2"	150		7,15 €
B-55706		1/2"	250		9,55 €

objednávacie číslo	popis	upínanie	dĺžka (mm)	pre model	cena s DPH
B-59835	adaptér 3/8"	7/16"	75	DTW800	3,81 €
B-59841	adaptér 1/2"	7/16"	75	DTW800	4,51 €

## Nástrčkové kľúče s upnutím štvorhran 1/2" \*\*\*\*\*



objednávacie číslo	popis	typ	vhodné pre stroj	cena s DPH
P-46953	sada nástrčkových kľúčov 9 ks	nástrčkový kľúč 5/16"	6905H_B, TW0200, TW0350	46,56 €
		nástrčkový kľúč 11/16"		
		nástrčkový kľúč 3/4"		
		nástrčkový kľúč 8 mm		
		nástrčkový kľúč 10 mm		
		nástrčkový kľúč 13 mm		
		nástrčkový kľúč 17 mm		
		nástrčkový kľúč 19 mm		
		nástrčkový kľúč 21 mm		

# Príslušenstvo pre rázové uťahováky

Nástrčkové kľúče s upnutím štvorhran 1/2"



objednávacie číslo	popis	typ	dĺžka (mm)	ks/bal.	vhodné pre stroj	cena s DPH	
134825-1	 nástrčkový kľúč	M8/SW13	38	1	6953, 6904V_H, 6905H_B, TW0200, TW0350	4,41 €	
134827-7		M8/SW13	52	1	6953, 6904V_H, 6905H_B, TW0200, TW0350	5,14 €	
134829-3		M10/SW17	38	1	6953, 6904V_H, 6905H_B, TW0200, TW0350	4,07 €	
134830-8		M10/SW17	52	1	6953, 6904V_H, 6905H_B, TW0200, TW0350	5,16 €	
134831-6		M12/SW19	38	1	6953, 6904V_H, 6905H_B, TW0200, TW0350	4,45 €	
134832-4		M12/SW19	52	1	6953, 6904V_H, 6905H_B, TW0200, TW0350	5,37 €	
134838-2		1/2"/SW21	38	1	6953, 6904V_H, 6905H_B, TW0200, TW0350	4,74 €	
134833-2		1/2"/SW21	52	1	6953, 6904V_H, 6905H_B, TW0200, TW0350	6,47 €	
134851-0		M14/SW22	38	1	6953, 6904V_H, 6905H_B, TW0200, TW0350	5,04 €	
134834-0		M14/SW22	52	1	6953, 6904V_H, 6905H_B, TW0200, TW0350	6,16 €	
134841-3		M16/SW24	45	1	6953, 6904V_H, 6905H_B, TW0200, TW0350	6,84 €	
134836-6		M16/SW24	52	1	6953, 6904V_H, 6905H_B, TW0200, TW0350	6,20 €	
134844-7		M18/SW27	50	1	6905H_B, TW0200, TW0350	7,43 €	
134845-5		M18/SW27	78	1	6905H_B, TW0200, TW0350	10,35 €	
134846-3		M20/SW30	50	1	6905H_B, TW0200, TW0350	7,60 €	
134847-1		M20/SW30	78	1	6905H_B, TW0200, TW0350	10,89 €	
134848-9		M22/SW32	50	1	6905H_B, TW0200, TW0350	7,78 €	
134849-7		M22/SW32	78	1	6905H_B, TW0200, TW0350	15,09 €	
213405-7		O krúžok k nástrčkovým kľúčom 1/2"			1		0,23 €
268057-9		čap k nástrčkovým kľúčom 1/2"			1		0,87 €
213506-1	O krúžok k nástrčkovým kľúčom 3/4"					0,29 €	
256282-4	čap k nástrčkovým kľúčom 3/4"					1,00 €	

# Príslušenstvo pre rázové uťahováky

## Nástrčkové kľúče s upnutím štvorhran 3/4"



objednávacie číslo	popis	typ	dĺžka (mm)	ks/bal.	vhodné pre stroj	cena s DPH
A-85494	nástrčkový kľúč	M10/SW17	50	1	6906	9,27 €
A-85519		M12/SW19	50	1	6906	9,33 €
A-85553		M14/SW22	52	1	6906	9,23 €
A-85575		M16/SW24	52	1	6906	10,12 €
134855-2		M18/SW27	52	1	6906	9,40 €
134856-0		M18/SW27	95	1	6906	26,80 €
134857-8		M20/SW30	52	1	6906	9,51 €
134858-6		M20/SW30	95	1	6906	19,61 €
134871-4		M22/SW32	52	1	6906	10,67 €
134859-4		M22/SW32	95	1	6906	21,39 €
134862-5		M24/SW36	56	1	6906	12,33 €
134863-3		M24/SW36	95	1	6906	21,38 €
213506-1		O krúžok k nástrčkovým kľúčom 3/4"			1	
256282-4	čap k nástrčkovým kľúčom 3/4"			1		1,00 €

## Nástrčkové kľúče s upnutím štvorhran 1"



objednávacie číslo	popis	typ	dĺžka (mm)	ks/bal.	vhodné pre stroj	cena s DPH
134865-9	nástrčkový kľúč	M24/SW36	80	1	TW1000	22,79 €
134872-2		M27/SW41	80	1	TW1000	22,79 €

## Sady nástrčkových kľúčov



objednávacie číslo	popis	obsahuje	cena s DPH
B-54645	9 dielna sada nástrčkových kľúčov	nadstavec 1/4" na 1/2" 8 x 30 mm 1/2" 10 x 30 mm 1/2" 12 x 30 mm 1/2" 13 x 30 mm 1/2" 14 x 30 mm 1/2" 15 x 30 mm 1/2" 17 x 30 mm 1/2" 18 x 30 mm 1/2"	27,56 €
B-54651	9 dielna sada nástrčkových kľúčov	nadstavec 1/4" na 3/8" 8 x 30 mm 3/8" 10 x 30 mm 3/8" 12 x 30 mm 3/8" 13 x 30 mm 3/8" 14 x 30 mm 3/8" 15 x 30 mm 3/8" 17 x 30 mm 3/8" 18 x 30 mm 3/8"	22,88 €

## Príslušenstvo

### Diamantové kotúče typy



#### Segmentový:

Najčastejšie používaný s diamantami v sadenými po okrajoch kotúča. Rýchle a pohodlné rezanie.



#### Segmentový zváraný laserom:

vrstva diamantu a kotúča sú zvárané laserovým lúčom nad 1000 ° C. Ideálne použitie s vysoko výkonným strojom.

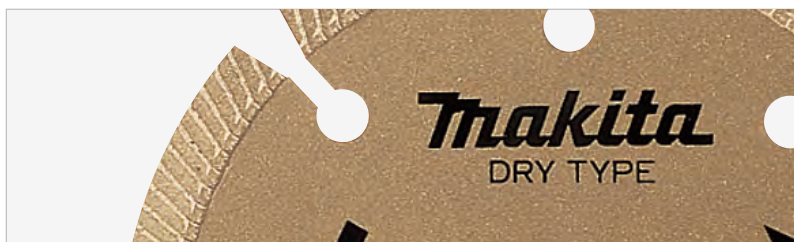

#### Segmentový so zárezmi:

tieto zárezy zabezpečujú:

- rýchle rezanie s menším odporom
- efektívnejšie odvádzanie rezného prachu
- menšia záťaž na kotúč



#### Turbo hrana:

rýchlejšie rezanie ako pri segmentových kotúčoch čistejší rez bez štrbín na rezanom materiále



#### Nedelená hrana:

Vrstva diamantov po celom obvode kotúča čistý a hladký rez aj na tvrdých materiáloch /keramické obklady, porcelán/

# Diamantové kotúče

Špeciálne diamantové rezné kotúče na rezanie namokro

pre modely 4190DW a 4191DWA

Celistvý uzavretý segment pre čisté rezy bez vyštrbených hrán.



\*\*\*\*

objednávacie číslo	ø kotúča (mm)	ø otvoru (mm)	hrúbka segmentu (mm)	výška segmentu (mm)	druh segmentu	farba	max. otáčky (min <sup>-1</sup> )	model	cena s DPH
B-21098	80	15	2,0	4,5	hladký	strieborná	2 380	4190DWA 4191DWA	33,70 €



objednávacie číslo	ø kotúča (mm)	ø otvoru (mm)	materiál	cena s DPH
B-53693	125	22,23	železo	49,29 €
B-53796	125	22,23	žula, mramor, betón	35,89 €







# Diamantové kotúče

Quasar

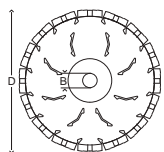

Špeciálny diamantový kotúč s technológiou 3D Grid pre univerzálne použitie a profesionálny výkon.

K dispozícii buď s technológiou Stealth, ktorá poskytuje vynikajúce tlmenie vibrácií a zvuku, a tým najlepší pocit, alebo so spevneným stredom a chladiacimi otvormi pre rýchle a pohodlné rezanie. Zvárané laserom. Na mokré a suché použitie.

Segmentovaná hrana – tichý kotúč s vysokou životnosťou – na rezanie Betón, stredne tvrdá / tvrdá tehla, terazzo, keramické dlaždice, bridlica

objednávacie číslo	ID číslo kotúča	ø kotúča (mm)	výška segmentu (mm)	B (mm)	prstenec (mm)	charakteristika	cena s DPH
B-12712	QDS23022XS	230	12	22,23		3DDG, Stealth	128,10 €
B-13459	QDS30020XS	300	12	20		3DDG, Stealth	190,47 €
B-17588	QDS30025XS	300	12	25,4		3DDG, Stealth	181,26 €
B-13465	QDS35025XS	350	12	25,4	20	3DDG, Stealth	245,99 €
B-13471	QDS40025XS	400	12	25,4	20	3DDG, Stealth	296,02 €

## Ako čítať nový identifikačný kód diamantových kotúčov Makita



Typ segmentu (Segment Type)  
 DS = diamantový segmentovaný  
 DT = diamantový turbo  
 DC = diamantový nedelený  
 DE = diamantový elektrolyticky pokovovaný  
 DM = diamantový na maltu (frézovanie škár)  
 DA = diamantový asfaltový

Priemer otvoru (v mm) (Bore Diameter)  
 15 = 15mm  
 16 = 16mm  
 20 = 20mm  
 22 = 22.23mm  
 25 = 25.4mm

**QDS30020XS**

Označenie (Brand)  
 Q = Quasar  
 C = Comet  
 N = Neutron  
 L = Laser (DiaMak+)  
 D = DiaMak

Priemer kotúča (v mm)  
 (Blade Diameter)

Špecifické charakteristiky (Special Features)  
 e = Enduro  
 r = Rapide  
 C = chladiace otvory  
 V = spevnené jadro  
 X = technológia 3D Diamond Grid  
 S = technológia Stealth

### PRÍKLADY

QDS30020XS: kotúč Quasar, diamantový segmentovaný, priemer 300 mm, priemer otvoru 20 mm, technológia 3D Diamond Grid, technológia Stealth

CDS40025rCX: kotúč Comet, diamantový segmentovaný, priemer 400 mm, priemer otvoru 25 mm, Rapide, chladiace otvory, technológia 3D Diamond Grid

NDS11522e: kotúč Neutron – priemer 115 mm, priemer otvoru 22,23 mm, Enduro



# Diamantové kotúče

## Comet

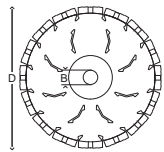

Špeciálny univerzálny kotúč s technológiou 3D Grid pre profesionálny výkon.

Široké spektrum kvalitných kotúčov s technológiou 3D Grid a voliteľnými prvkami ako technológia Stealth alebo chladiace otvory. K dispozícii v segmentových špecifikáciách Rapide a Enduro pre maximalizáciu rýchlosti alebo životnosti.

Zvárané laserom. Na mokré a suché použitie.

Segmentovaná hrana pre rýchle rezanie

Betón, stredne tvrdá/tvrdá tehla, terazzo, keramické dlaždice, bridlica, keramická rúra

**RAPIDE**

objednávacie číslo	ID číslo kotúča	ø kotúča (mm)	výška segmentu (mm)	B (mm)	prstenec (mm)	charakteristika	cena s DPH
B-12762	CDS11522rC	115	10	22,23		Rapide, chladiace otvory	50,70 €
B-12778	CDS12522rC	125	10	22,23	20	Rapide, chladiace otvory	46,53 €
B-27187	CDS15022C	150	10	22,23		Rapide, chladiace otvory	56,35 €
B-27193	CDS18022C	180	10	22,23		Rapide, chladiace otvory	82,33 €
B-12784	CDS23022rCX	230	10	22,23		3DDG, Rapide, chladiace otvory	103,88 €
B-13546	CDS30020rCX	300	10	20		3DDG, Rapide, chladiace otvory	156,84 €
B-17619	CDS30025rCX	300	10	25,4		3DDG, Rapide, chladiace otvory	147,06 €
B-13552	CDS35025rCX	350	10	25,4	20	3DDG, Rapide, chladiace otvory	187,20 €
B-13568	CDS40025rCX	400	10	25,4	20	3DDG, Rapide, chladiace otvory	225,77 €





# Diamantové kotúče

Comet

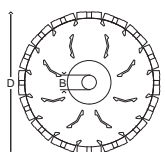

Špeciálny univerzálny kotúč s technológiou 3D Grid pre profesionálny výkon.

Široké spektrum kvalitných kotúčov s technológiou 3D Grid a voliteľnými prvkami ako technológia Stealth alebo chladiace otvory. K dispozícii v segmentových špecifikáciách Rapide a Enduro pre maximalizáciu rýchlosti alebo životnosti.

Zvárané laserom. Na mokré a suché použitie.

*Turbo hrana na rezanie*

*Tvrdá tehla, žula, vápenc, keramická rúra, bridlica, terazzo, granit*

objednávacie číslo	ID číslo kotúča	ø kotúča (mm)	výška segmentu (mm)	B (mm)	prstenec (mm)	charakteristika	cena s DPH
B-12974	CDT10016	100	7	16		Turbo hrana, štandardné jadro	39,66 €
B-12980	CDT11522	115	7	22,23		Turbo hrana, štandardné jadro	32,64 €
B-12996	CDT12522	125	7	22,23	20	Turbo hrana, štandardné jadro	38,89 €
B-13007	CDT15022	150	7	22,23	20	Turbo hrana, štandardné jadro	49,70 €
B-13013	CDT17522	175	7	22,23		Turbo hrana, štandardné jadro	61,80 €
B-13029	CDT20030	200	7	30	25,4	Turbo hrana, štandardné jadro	68,54 €
B-13035	CDT23022	230	8	22,23		Turbo hrana, štandardné jadro	82,37 €
B-13041	CDT30025	300	8,5	25,4		Turbo hrana, štandardné jadro	160,69 €
B-13057	CDT35025	350	8,5	25,4		Turbo hrana, štandardné jadro	251,08 €



*Nedelená hrana na rezanie keramiky, porcelánu, dlaždíc z mramoru a bridlice*

objednávacie číslo	ID číslo kotúča	ø kotúča (mm)	výška segmentu (mm)	B (mm)	prstenec (mm)	charakteristika	cena s DPH
B-13063	CDC8015	80	5	15		súvislá hrana, štandardné jadro	40,13 €
B-13079	CDC10016	100	5	16		súvislá hrana, štandardné jadro	27,11 €
B-13085	CDC11522	115	5	22,23		súvislá hrana, štandardné jadro	22,14 €
B-13091	CDC12522	125	5	22,23	20	súvislá hrana, štandardné jadro	25,27 €
B-13100	CDC15022	150	5	22,23	20	súvislá hrana, štandardné jadro	38,85 €
B-13116	CDC17522	175	5	22,23		súvislá hrana, štandardné jadro	43,86 €
B-13122	CDC20030	200	5	30	25,4	súvislá hrana, štandardné jadro	39,69 €
B-13138	CDC23030	230	5	30	25,4	súvislá hrana, štandardné jadro	52,17 €
B-13144	CDC30025	300	7	25,4		súvislá hrana, štandardné jadro	179,05 €
B-13150	CDC35030	350	7	30	25,4	súvislá hrana, štandardné jadro	146,88 €



# Diamantové kotúče

## Comet

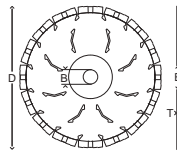

Špeciálny univerzálny kotúč s technológiou 3D Grid pre profesionálny výkon.  
Široké spektrum kvalitných kotúčov s technológiou 3D Grid a voliteľnými prvkami ako technológia Stealth alebo chladiace otvory. K dispozícii v segmentových špecifikáciách Rapide a Enduro pre maximalizáciu rýchlosti alebo životnosti.  
Zvárané laserom. Na mokré a suché použitie.

Elektrolyticky pokovovaný kotúč na rezanie  
Mramor, sklenené vlákno, drevovláknitá doska, sklolaminát

objednávacie číslo	ID číslo kotúča	ø kotúča (mm)	výška segmentu (mm)	B (mm)	prstenec (mm)	charakteristika	cena s DPH
B-13166	CDE10016	100	-	16		elektrolyticky pokovovaný, štandardné jadro	53,53 €
B-13172	CDE11522	115	-	22,23		elektrolyticky pokovovaný, štandardné jadro	52,29 €
B-13188	CDE12522	125	-	22,23	20	elektrolyticky pokovovaný, štandardné jadro	62,28 €
B-13194	CDE15022	150	-	22,23	20	elektrolyticky pokovovaný, štandardné jadro	67,45 €
B-13203	CDE17522	175	-	22,23		elektrolyticky pokovovaný, štandardné jadro	75,24 €
B-13219	CDE23022	230	-	22,23		elektrolyticky pokovovaný, štandardné jadro	129,96 €
B-13225	CDE25022	250	-	22,23		elektrolyticky pokovovaný, štandardné jadro	239,40 €



Kotúč na frézovanie škár pre vyškrabávanie malty  
Malta, mäkká tehla

objednávacie číslo	ID číslo kotúča	ø kotúča (mm)	výška segmentu (mm)	B (mm)	prstenec (mm)	charakteristika	cena s DPH
B-13231	CDM10016	100	6,5	22,23		frézovanie škár, štandardné jadro 6,5 x 6,4	87,68 €
B-13247	CDM11522	115	6,5	22,23		frézovanie škár, štandardné jadro 6,5 x 6,4	95,63 €
B-13253	CDM12522	125	6,5	22,23		frézovanie škár, štandardné jadro 6,5 x 6,4	105,14 €



Segmentovaná hrana, asfaltový kotúč na rezanie  
Asfalt, hrubozrnný vápenec, hrubozrnný pieskovec, abrazívny pieskovec, mäkká tvárnica

objednávacie číslo	ID číslo kotúča	ø kotúča (mm)	výška segmentu (mm)	B (mm)	prstenec (mm)	charakteristika	cena s DPH
B-13269	CDA30020	300	10	20		asfalt, štandardné jadro	178,44 €
B-13275	CDA35025	350	10	25,4	20	asfalt, štandardné jadro	195,51 €
B-42905	CDA40025	400	10	25,4	20	asfalt, štandardné jadro	280,42 €



# Diamantové kotúče

nebula

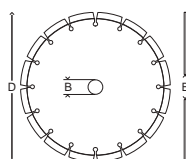

Špeciálny kotúč laserom zváraný segment na betón

objednávacie číslo	Ø kotúča (mm)	výška segmentu (mm)	B (mm)	prstenec (mm)	hrúbka (mm)	použitie	charakteristika	cena s DPH
B-53986	115	10	22,23	–	2,0	suchý rez	laserom zváraný	17,09 €
B-53992	125	10	22,23	–	2,0	suchý rez	laserom zváraný	21,36 €
B-54003	150	10	22,23	–	2,0	suchý rez	laserom zváraný	25,29 €
B-54019	180	10	22,23	–	2,0	suchý rez	laserom zváraný	30,37 €
B-54025	230	10	22,23	–	2,4	suchý rez	laserom zváraný	33,60 €
B-54031	300	10	20	–	2,8	suchý/mokrý rez	laserom zváraný	63,89 €
B-54047	300	10	20	–	2,8	suchý/mokrý rez	laserom zváraný	63,08 €
B-54053	350	10	25,4	20	3,0	suchý/mokrý rez	laserom zváraný	81,58 €
B-54069	400	10	25,4	20	3,0	suchý/mokrý rez	laserom zváraný	104,96 €
B-54075	450	10	25,4	–	3,4	suchý/mokrý rez	laserom zváraný	231,87 €





# Diamantové kotúče

## Diamak

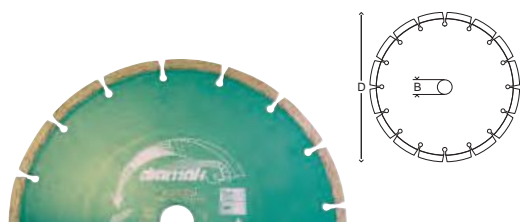

Ekonomické kotúče vstupnej úrovne vhodné pre široké spektrum stavebných materiálov.  
K dispozícii vo viacerých variantoch – segmentované, turbo a nedelené.  
Na použitie za mokra aj za sucha.

Segmentovaná hrana – na rezanie

Väčšina murárskych materiálov, dosky, tehly, blokový pieskovec, bridlica a vápenec.

objednávacie číslo	charakteristika	použitie	rez	Ø kotúča (mm)	B ( mm )	cena s DPH
D-61123	Segmentový kotúč	betón	suchý	115	22.23	5,34 €
D-61139	Segmentový kotúč	betón	suchý	125	22.23	6,44 €
D-61145	Segmentový kotúč	betón	suchý	230	22.23	14,75 €
D-61151	Turbo kotúč	betón	suchý	115	22.23	5,62 €
D-61167	Turbo kotúč	betón	suchý	125	22.23	6,61 €
D-61173	Turbo kotúč	betón	suchý	230	22.23	18,19 €



objednávacie číslo	popis	rozmer	poznámka	cena s DPH
D-56982	diamantový kotúč na betón	300 x 25,4 mm	redukčný krúžok 25,4 mm na 20 mm suchý rez	60,11 €
D-56998	diamantový kotúč na betón	350 x 25,4 mm	redukčný krúžok 25,4 mm na 20 mm suchý rez	78,14 €
D-57009	diamantový kotúč na betón	400 x 25,4 mm	redukčný krúžok 25,4 mm na 20 mm suchý rez	92,62 €



# Diamantové kotúče

## Diamak

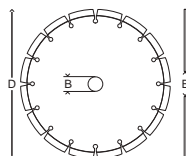

Ekonomické kotúče vstupnej úrovne vhodné pre široké spektrum stavebných materiálov.  
K dispozícii vo viacerých variantoch – segmentované, turbo a nedelené.  
Na použitie za mokra aj za sucha.

Nedelená hrana – na rezanie

Na rezanie dlaždíc, mramoru, vápenca, porcelánu, terazza.

objednávacie číslo	ID číslo kotúča	ø kotúča (mm)	výška segmentu (mm)	B (mm)	prsteneček (mm)	charakteristika	cena s DPH
D-61189		115		22,23		nedelená hrana	4,98 €
P-27218	DDC150	150	7	22,23		nedelená hrana, štandardné jadro	22,85 €
P-27224	DDC180	180	7	22,23		nedelená hrana, štandardné jadro	40,59 €
D-61195		200		25,4		nedelená hrana	11,32 €
D-61204		250		30 / 25,4		nedelená hrana	21,11 €

Nedelená hrana ,určený na jemné planírovanie betónu brúskou PC1100, obsahuje špeciálne jemné diamantové zrno

objednávacie číslo	ø kotúča (mm)	ø otvoru (mm)	hrúbka segmentu (mm)	výška segmentu (mm)	druh segmentu	farba	max. otáčky (min <sup>-1</sup> )	model	cena s DPH
792289-1	110	15,00	13,0	5,4	hladký	strieborná	13 900	PC1100	261,33 €





# Diamantové kotúče

## Diamantový kotúč (segmentovaný)



objednávacie číslo	ø kotúča (mm)	prsteneček (mm)	charakteristika	cena s DPH
D-41589	115	22,23	suchý rez / betón	8,34 €
D-41595	125	22,23	suchý rez / betón	9,44 €
D-41610	230	22,23	suchý rez / betón	22,68 €

## Diamantový kotúč (turbo)











objednávacie číslo	ø kotúča (mm)	prsteneček (mm)	charakteristika	cena s DPH
D-41626	115	22,23	suchý rez / betón	8,19 €
D-41632	125	22,23	suchý rez / betón	10,14 €
D-41654	230	22,23	suchý rez / betón	22,45 €





# Diamantové brúsne kotúče

Diamak+

	objednávacie číslo	ø D kotúča (mm)	ø otvoru (mm)	zrno	ks/bal.	cena s DPH
 <b>ODĽAHČUJÚCE VYSLOBODZOVACIE KOTÚČE</b> Odľahčujúce vyslobodzovacie kotúče môžu rezať väčšinu materiálov vrátane kovu, skla, muriva a kameňa.	A-36756	125	22,23		1	131,22 €
	A-89894	230	22,23		1	396,90 €
	A-88808	305	20		1	629,21 €
 <b>JEDNODIELNA HRANA GJ2</b> Určený pre PC1100, ideálny na brúsenie, ponúka rýchle obrusovanie materiálu.	P-29094	110	15		1	129,25 €
 <b>NEDELENÁ HRANA GD80</b> Určený na jemné planírovanie betónu brúskou PC1100, obsahuje špeciálne jemné diamantové zrno.	P-29088	110	15		1	249,70 €
 <b>ŠPIRÁLOVÁ HRANA SBG4</b> Určený na obrusovanie väčších plôch na 230 mm uhlovej brúske.	P-40652	180	22,23		1	204,98 €
 <b>DVOJITÁ HRANA SBG5</b> Ideálna brúsna hlava na bežné použitie, dvojitá hrana poskytuje dobrú stabilitu a rýchle obrusovanie. 110 mm kotúč môže byť použitý na brúske PC1100.	P-29103	110	22,23/15		1	127,30 €
	P-29119	180	22,23		1	238,27 €
 <b>SEGMENTOVANÁ HRANA SO ŽIVICOVÝM POJIVOM SBGR4</b> Vynikajúci nástroj na prefabrikovaný betón. Výplň so živicovým spojivom zaisťuje nízke vyštrbovanie na okrajoch. Možno ho tiež použiť na väčšinu typov kamena.	P-40668	100	M14		1	127,30 €
 <b>SEGMENTOVANÁ HRANA SBG8</b> Ideálny na prácu s pieskovcom a hrubozrnným pieskovcom. Má špeciálne formulované tvrdé spojivo, ktoré poskytuje vyššiu životnosť pri práci s uvedenými materiálmi.	P-29147	100	M14		1	153,41 €
 <b>TURBO HRANA SBG2</b> Ideálny na prácu s tvrdými kamenmi ako žula, mramor a vápenec, môže byť použitý na mokré použitie na brúskach na leštenie kameňa.	P-29050	100	M14		1	130,23 €
	P-40646	180	22,23		1	267,65 €
 <b>LEŠTIČKA KAMENA PW5000</b> <b>DIAMANTOVÉ DOŠTICKY</b>	D-15584			50	1	13,51 €
	D-15590			100	1	14,65 €
	D-15609			200	1	14,17 €
	D-15615			400	1	10,90 €
	D-15621			800	1	11,89 €
	D-15637			1500	1	17,67 €
	D-15643			3000	1	14,48 €
	D-15659			dolešťovanie	1	22,29 €
	D-15805			sada 8 ks	8	133,29 €
	417322-5			kryt hlavy	1	5,40 €



# Príslušenstvo pre prestrihovače

## Príslušenstvo pre prestrihovače, nožnice na plech



objednávacie číslo	popis	vhodné pre stroj	cena s DPH
A-83951		JN1601, DJN161, BJN161	30,77 €
792728-1	razník	JN3200, JN3201	32,20 €
792265-5		JN1600	35,45 €
A-15051	matrica	JN1601, DJN161, BJN161	20,33 €
792292-2		JN3200, JN3201	28,04 €
792264-7		JN1600	132,62 €
191383-0		JS1600, JS1602	31,68 €
792533-6	sada nožov	JS1660, JS1601	56,22 €
792536-0		JS1670, BJS101, DJS101, JS1000	50,00 €
792287-5		JS3200, JS3201	36,53 €
792534-4	rezný nôž	JS1660, JS1601	78,43 €
792537-8		JS1670, BJS101, DJS101, JS100	97,13 €
762013-6	mierka	JS1660,	3,17 €
762007-1		JN3200, JS3200, JS3201	2,32 €
199087-8			79,87 €

## Použitie



názov	mäkká oceľ		ušľachtilá oceľ		model
rezný nôž	silá	odstup (A)	silá	odstup (A)	
	1,6 mm	100 mm	1,2 mm	80 mm	JS1600
	1,2 mm	neobmedzené	do 1 mm	neobmedzené	
	3,2 mm	90 mm	2,5 mm	70 mm	JS3200
	2,3 mm	neobmedzené	2 mm	neobmedzené	

výrezy max. strižné rádiusy	D		
		21 mm	
	t	5 mm	JN1601
	R	50 mm	
	D	42 mm	
	t	8 mm	JN3200
	R	128 mm	

# Príslušenstvo pre aku prestrihovače

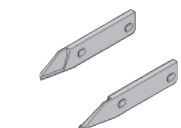

objednávacie číslo	popis	upínanie	cena s DPH
792742-7	Nôž pravý	DJS130, BJS130, DJS130	49,60 €
792743-5	Nôž ľavý	DJS130, BJS130, DJS130	45,88 €
792744-3	Nôž stredný	DJS130, BJS130, DJS130	58,10 €
792536-0	Sada bočných nožov	DJS101	50,00 €
792537-8	Nôž stredný	DJS101	97,13 €
199087-8	nôž M6	DSC102	79,87 €
199085-2	nôž M8	DSC102	79,10 €
199083-6	nôž M10	DSC102	78,62 €
SC09002890	kotúč pilový 110 x 15mm 24Z	DSC250	161,38 €

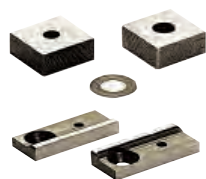



# Rezné kotúče

## Rezný kotúč na kovy

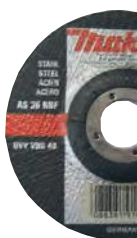

**Rezný kotúč na kovy** – Rezný kotúč, lisovaný za studena, s pojivom zo syntetickej živice. Univerzálny kotúč, použiteľný vo všetkých oblastiach opracúvania kovov. Vysoký rezný výkon pri dobrej životnosti.

objednávacie číslo	ø kotúča (mm)	ø otvoru (mm)	hrúbka (mm)	ks/bal	cena s DPH
P-53001	115	22	1	1	1,38 €
B-14102	115	22,23	1,6	1	1,03 €
A-85307	115	22	2,5	1	0,92 €
P-53023	125	22	1	1	1,45 €
B-35134	125	22,23	1,6	1	1,15 €
B-64618	230	22	1,9	1	3,35 €
A-85313	125	22	2,5	1	1,07 €
P-05751	150	22	2,5	1	2,10 €
A-85329	180	22	2,5	1	1,61 €
A-85335	230	22	2,5	1	2,10 €
B-60464	230	22,23	2	1	2,47 €
B-49448-5*	355	25,4	2,5	5	19,99 €
B-64696-5	355	25,4	2,5	5	26,99 €
B-10665-5	355	25,4	3	5	18,66 €
B-64353-5	355	25,4	3	5	18,99 €
A-87694-25	405	25,4	3	25	116,99 €

\*rýchly rez, dlhšia životnosť

## Rezný kotúč na kameň



**Rezný kotúč na kameň** – Rezný kotúč, lisovaný za studena, s pojivom zo syntetickej živice. Univerzálny kotúč na rezanie prírodného a umelého kameňa, bridlice, mramoru, neželezných kovov. Vysoký rezný výkon pri dlhej životnosti.

objednávacie číslo	ø kotúča (mm)	ø otvoru (mm)	hrúbka (mm)	ks/bal	cena s DPH
A-85357	115	22	3	1	1,15 €
P-52205	115	22	3,2	1	1,20 €
A-85363	125	22	3	1	1,46 €
P-52940	125	22	3,2	1	1,43 €
A-85379	180	22	3	1	2,08 €
A-85385	230	22	3	1	2,86 €
P-52211	230	22	3,2	1	2,98 €
966121122	300	20	3,5	1	17,17 €
A-89735	305	25,4	3,5	1	7,58 €
966164022	400	25,4	4	1	38,78 €

## Rezný kotúč na nerez/železo



**MIMORIADNE TENKÝ rezný kotúč** – Tenký, stredne tvrdý, vysokovýkonný rezný kotúč. Vhodný najmä na tenkostenné materiály ako rúry, profily, plechy a drôty. Nižšie zaťaženie náradia, menšia spotreba materiálu, menšie úsilie pri rezaní. Mimoriadne vysoký rezný výkon pri optimálnej životnosti.

objednávacie číslo	ø kotúča (mm)	ø otvoru (mm)	hrúbka (mm)	ks/bal	cena s DPH
B-45727	115	22	0,8	1	1,36 €
B-45755	115	22,23	1,6	1	1,01 €
B-45733	125	22	0,8	1	1,50 €
B-46931	125	22,23	1,6	1	1,09 €



# Rezné kotúče

## Rezný kotúč na nehrdzavejúcu oceľ



**MIMORIADNE TENKÝ rezný kotúč na ušľachtilú oceľ** – Tenký, stredne tvrdý, vysokovýkonný rezný kotúč. Vhodný najmä na tenkostenné materiály ako rúry, profily, plechy a drôty z nehrdzavejúcej ocele. Nižšie zaťaženie náradia, menšia spotreba materiálu, menšie úsilie pri rezaní. Mimoriadne vysoký rezný výkon pri optimálnej životnosti.

objednávacie číslo	ø kotúča (mm)	ø otvoru (mm)	hrúbka (mm)	ks/bal	cena s DPH
B-12201	100	16	1	1	1,15 €
P-52249	115	22	1	1	1,41 €
B-12217	115	22	1	1	1,19 €
P-53045	125	22	1	1	1,42 €
B-12239	125	22	1	1	1,39 €
P-53051	125	22	1,6	1	1,46 €
B-12251	150	22	1,6	1	1,46 €
B-12267	180	22	1,6	1	1,44 €
B-12273	230	22	1,9	1	2,68 €
P-53067	230	22	2	1	3,42 €
B-64571-5	305	25,4	2,8	5	22,99
B-64565-5	355	25,4	2,8	5	29,99

## Rezný kotúč na hliník

**Rezný kotúč na hliník** – Rezný kotúč, lisovaný za studena, s pojivom zo syntetickej živice. Vhodný na rezanie hliníkových materiálov. Vysoký rezný výkon pri dlhej životnosti.

objednávacie číslo	ø kotúča (mm)	ø otvoru (mm)	hrúbka (mm)	ks/bal	cena s DPH
P-53126	115	22	1	1	1,45 €
B-45331	125	22,23	1	1	1,30 €
B-45347	150	22,23	1,6	1	1,49 €
B-45369	230	22,23	1,9	1	2,76 €
P-53132	230	22	2	1	3,66 €

## 2 v 1 rezný / brúsny kotúč na nerez a železo, vhodný pre akumulátorové brúsky



objednávacie číslo	ø kotúča (mm)	ø otvoru (mm)	hrúbka (mm)	ks/bal	cena s DPH
B-50360	115	22,23	2	1	1,72 €
B-51655	125	22,23	2,2	1	1,79 €



# Brúsne kotúče

Brúsny kotúč na oceľ a nehrdzavejúcu oceľ



objednávacie číslo	ø kotúča (mm)	ø otvoru (mm)	hrúbka (mm)	ks/bal.	cena s DPH
A-80852	100	16	6	1	1,21 €
B-49775	115	22	4	1	2,02 €
A-80640	115	22	6	1	1,50 €
B-53110	125	22	4	1	1,99 €
A-80656	125	22	6	1	2,67 €
A-80846	150	22	6	1	2,02 €
A-80880	180	22	6	1	2,71 €
A-80896	230	22	6	1	4,32 €
B-14560	115	22	6	1	1,46 €
B-17653	125	22	6	1	1,75 €
B-14576	180	22	6	1	2,59 €
B-14582	230	22	6	1	5,81 €



# Brúsne kotúče na kovy

Brúsne kotúče Makita sú stredne tvrdé univerzálne kotúče, určené pre všetky oblasti opracúvania kovov. Brúsne kotúče majú hrubú zrnitosť a používajú sa na miestach, kde sa požaduje vysoký úberový výkon. Vzhľad výbrusu je zodpovedajúco hrubý. Oblasti využitia: začisťovanie zvarov; brúsenie liatinových odliatok; brúsenie hrán a plôch; brúsenie rohových zvarov; brúsenie bodových zvarov; zahladzovanie a výbrus okovín.

## Brúsny kotúč na kovy

Stredne tvrdý, univerzálny brúsny kotúč na celkové opracúvanie normálnej ocele, napr. na odstraňovanie okovín, brúsenie hrán a výbrus plôch.

Mimoriadnou prednosťou tohto kotúča je optimálny pomer ceny a výkonu.

\*\*\*



objednávacie číslo	ø kotúča (mm)	ø otvoru (mm)	hrúbka (mm)	ks/bal.	Max. otáčky (min <sup>-1</sup> )	model	cena s DPH
D-18459	115	22,0	6,0	1	13 290	115 mm uhlové brúsky	1,26 €
D-18465	125	22,0	6,0	1	12 200	125 mm uhlové brúsky	1,47 €

Univerzálny, stredne tvrdý brúsny kotúč, lisovaný za studena, s pojivom zo syntetickej živice, na celkové opracúvanie ocele, napr. na odstraňovanie okovín, brúsenie hrán a výbrus plôch.

Mimoriadnou prednosťou tohto kotúča je vysoký úberový výkon pri optimálnej životnosti.

\*\*\*



objednávacie číslo	ø kotúča (mm)	ø otvoru (mm)	hrúbka (mm)	ks/bal.	cena s DPH
A-80927	115	22	6	1	1,15 €
A-80933	125	22	6	1	1,36 €
P-52984	125	22	6,4	1	1,81 €
A-84981	150	22	6	1	1,61 €
P-52990	150	22	6,4	1	2,82 €
A-80949	180	22	6	1	1,79 €
A-80955	230	22	6	1	3,19 €
P-52819	230	22	7	1	4,80 €



# Brúsne kotúče na kovy



objednávacie číslo	rozmer	model	cena s DPH
A-80927	115 × 6 × 22	brúsny kotúč na kov	1,15 €
A-80933	125 × 6 × 22	brúsny kotúč na kov	1,36 €
A-84981	150 × 6 × 22	brúsny kotúč na kov	1,61 €
A-80949	180 × 6 × 22	brúsny kotúč na kov	1,79 €
A-80955	230 × 6 × 22	brúsny kotúč na kov	3,19 €
B-46361	125 × 6 × 22	brúsny kotúč na nehrdzavejúcu oceľ	1,60 €
B-46383	230 × 6 × 22	brúsny kotúč na nehrdzavejúcu oceľ	4,18 €
A-80852	100 × 6 × 16	brúsny kotúč na oceľ a nehrdzavejúcu oceľ	1,21 €
B-49775	115 × 4 × 22	brúsny kotúč na oceľ a nehrdzavejúcu oceľ	2,02 €
A-80640	115 × 6 × 22	brúsny kotúč na oceľ a nehrdzavejúcu oceľ	1,50 €
A-80656	125 × 6 × 22	brúsny kotúč na oceľ a nehrdzavejúcu oceľ	2,67 €
A-80846	150 × 6 × 22	brúsny kotúč na oceľ a nehrdzavejúcu oceľ	2,02 €
A-80880	180 × 6 × 22	brúsny kotúč na oceľ a nehrdzavejúcu oceľ	2,71 €
A-80896	230 × 6 × 22	brúsny kotúč na oceľ a nehrdzavejúcu oceľ	4,32 €
B-14560	115 × 6 × 22	brúsny kotúč na hliník	1,46 €
B-14576	180 × 6 × 22	brúsny kotúč na hliník	2,59 €
B-14582	230 × 6 × 22	brúsny kotúč na hliník	5,81 €





## Brúsne kotúče na kovy

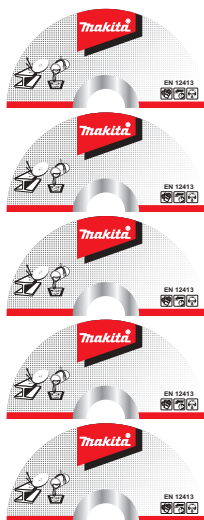

objednávacie číslo	rozmer	model	cena s DPH
B-21107	100 × 6 × 16	brúsny kotúč HEAVY DUTY na kov, železo a INOX	0,98 €
B-21113	115 × 6 × 22	brúsny kotúč HEAVY DUTY na kov, železo a INOX	1,25 €
B-21129	125 × 6 × 22	brúsny kotúč HEAVY DUTY na kov, železo a INOX	1,82 €
B-21135	180 × 6 × 22	brúsny kotúč HEAVY DUTY na kov, železo a INOX	2,63 €
B-21141	230 × 6 × 22	brúsny kotúč HEAVY DUTY na kov, železo a INOX	4,11 €



## Frézovacie kotúče pre CA5000



objednávacie číslo	rozmer	model	cena s DPH
B-48832	118 × 20	frézovací kotúč (pre CA5000) na hliník pre 90° ohyb materiálu.	182,07 €
B-48860	118 × 20	frézovací kotúč (pre CA5000) na hliník pre 135° ohyb materiálu.	209,44 €

## príslušenstvo

### brúsny kotúč



### Štruktúra

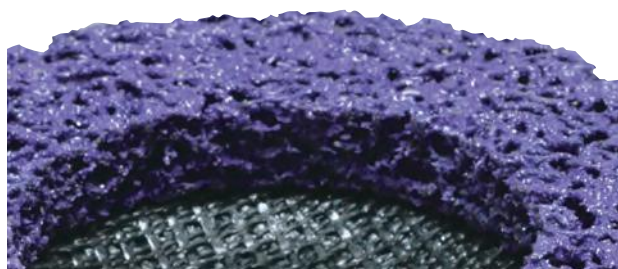

### Špeciálny kotúč na odstraňovanie farieb

#### Grit (SiC)

Štruktúra kotúča Sic(karbid kremíka) a vlákna umožňujú rýchle a zároveň šetrné brúsenie materiálu bez väčšej námahy.

#### Fiber

Zapuzdrené vlákna pôsobia šetrne na materiál a zabráňujú príliš veľa od brúsenia a poškrabaniu ocele.

### Vlastnosti

Rozdiel pri použití na rovnakom materiály.



špeciálny kotúč

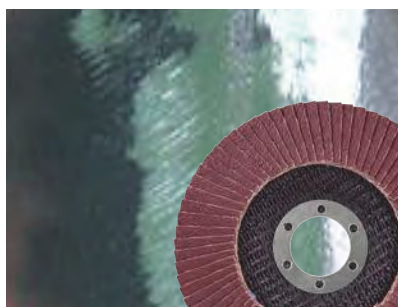

lamelový kotúč



brúsny kotúč

### Použitie



\*odstraňovanie farby



\*odstraňovanie hrdze



\*odstraňovanie farebných defektov po zvaroch

# Príslušenstvo

## Lamelové kotúče

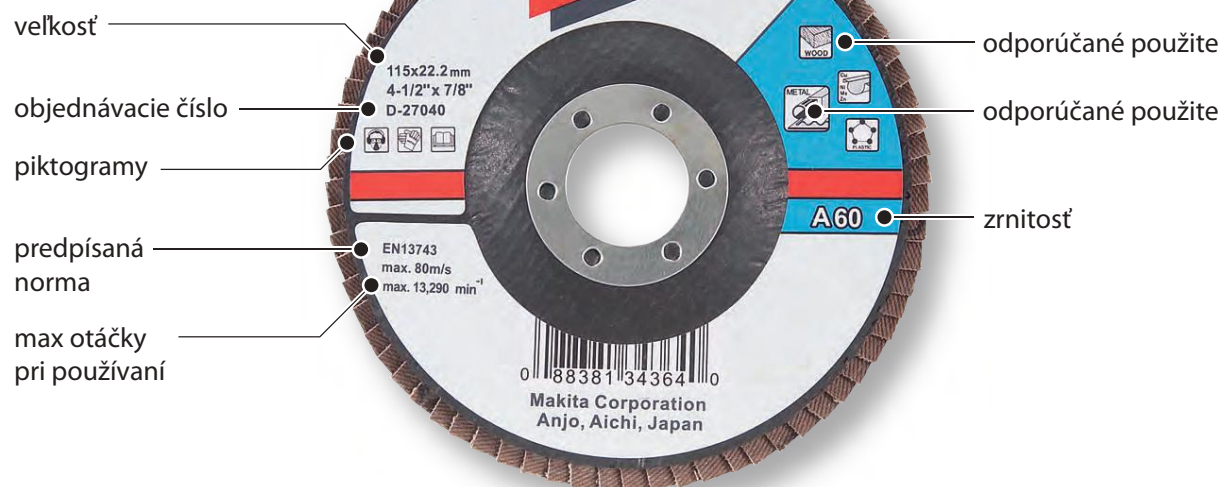

### Typ uchytienia



**podložka zo sklenených vlákien**  
štandardný typ podkladu



**nylónová podložka**  
For heavy duty

### Tvar kotúča



**plochý**  
pre rovné povrchy

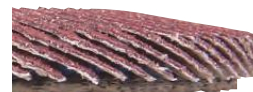

**zaoblený**  
použitie pri uhloch a rohoch

AA : odporúčané

A : prijateľný

zloženie brusiva	Aluminum oxide	Zirconia alumina	Silicon carbide	Ceramic aluminum oxide
popis a farba štítka	určený na železo 	určený na železo a nerez 	určené pre murivo 	určený na železo, nerez a neželezné kovy 
drevo	A			
PVC	A			
železo	AA	AA		AA
neželezné kovy	A	A		AA
nerez		AA		AA
murivo			AA	



# Lamelové brúsne kotúče na ocel'

Brúsne zrno z korundu je vhodné najmä na brúsenie mäkkej ocele. Lamelové brúsne kotúče sú optimálne ako na hrubý výbrus, tak aj na finálny výbrus a leštenie. Brúsne listy kotúča majú vejárovité usporiadanie, navzájom sa prekrývajú a sú upevnené na vysokokvalitnom kotúči s vláknami zo sklolaminátu.

Najdôležitejšie prednosti lamelových brúsnych kotúčov: vysoký a konštantný úberový výkon, studený výbrus; vysoká kvalita výbrusu; dlhá životnosť; nízka hlučnosť.

Oblasti využitia: odhrdzovanie; výbrus odliatkov; znášanie hrán; výbrus plôch; odstraňovanie farieb/tmelov; finálny výbrus. Vhodný materiál: hliník; mäkké neželezné kovy a ich zliatiny; rôzne stavebné ocele; plasty; drevo; liatina.

## Lamelový brúsny kotúč na ocel' „Korund“



objednávacie číslo	ø kotúča (mm)	ø otvoru (mm)	zrניות	Max. otáčky (min <sup>-1</sup> )	model	cena s DPH
P-65137	115	22,2	40	13 300	115 mm uhlové brúsky	2,77 €
P-65143	115	22,2	60	13 300	115 mm uhlové brúsky	2,72 €
P-65159	115	22,2	80	13 300	115 mm uhlové brúsky	2,72 €
P-65165	115	22,2	120	13 300	115 mm uhlové brúsky	2,73 €
P-65171	125	22,2	40	12 000	125 mm uhlové brúsky	3,26 €
P-65187	125	22,2	60	12 000	125 mm uhlové brúsky	3,26 €
P-65193	125	22,2	80	12 000	125 mm uhlové brúsky	3,26 €
P-65202	125	22,2	120	12 000	125 mm uhlové brúsky	3,26 €
P-65218	150	22,2	40	10 200	150 mm uhlové brúsky	4,86 €
P-65224	150	22,2	60	10 200	150 mm uhlové brúsky	4,86 €
P-65230	150	22,2	80	10 200	150 mm uhlové brúsky	4,86 €
P-65246	150	22,2	120	10 200	150 mm uhlové brúsky	4,87 €
P-65252	180	22,2	40	8 600	180 mm uhlové brúsky	7,28 €
P-65268	180	22,2	60	8 600	180 mm uhlové brúsky	6,93 €
P-65274	180	22,2	80	8 600	180 mm uhlové brúsky	7,08 €
P-65280	180	22,2	120	8 600	180 mm uhlové brúsky	6,95 €





# Brúsne kotúče na kovy

## Brúsny kotúč na odstraňovanie farby



objednávacie číslo	ø kotúča (mm)	ø otvoru (mm)	Max. otáčky (min <sup>-1</sup> )	popis	cena s DPH
B-28977	115	22,23	12 000	brúsny kotúč na odstraňovanie farby /železo, nerez, med/	10,70 €
B-28983	125	22,23	12 000	brúsny kotúč na odstraňovanie farby /železo, nerez, med/	11,67 €

## Brúsny kotúč na odstraňovanie farby – LONGLIFE



objednávacie číslo	ø kotúča (mm)	ø otvoru (mm)	Max. otáčky (min <sup>-1</sup> )	popis	cena s DPH
B-29016	115	22,23	12 000	brúsny kotúč na odstraňovanie farby /železo, nerez, med/	11,30 €
B-29022	125	22,23	12 000	brúsny kotúč na odstraňovanie farby /železo, nerez, med/	13,42 €



# Lamelové brúsne kotúče na ušľachtilú oceľ

Brúsne zrno zo zirkónového korundu je vhodné najmä na agresívny výbrus a vysoké namáhanie a je preto optimálne ako na hrubý úber, tak aj na finálny výbrus a leštenievrdej ocele. Brúsne listy kotúča majú vejárovité usporiadanie, navzájom sa prekrývajú a sú upevnené na vysokokvalitnom kotúči s vláknami zo sklolaminátu.

Najdôležitejšie prednosti lamelových brúsnych kotúčov: mimoriadne vysoký a konštantný úberový výkon; vysoká kvalita povrchu; dlhá životnosť; nízka hlučnosť.

Oblasti využitia: odstraňovanie okovín; výbrus odliatkov; znášanie hrán; výbrus plôch; odstraňovanie hrdze/tmelov; finálny výbrus.

Vhodný materiál: ušľachtilá oceľ; neželezné kovy a ich zliatiny; rôzne stavebné ocele; hliník; drevo; liatina.

## Lamelový brúsny kotúč na ušľachtilú oceľ „Zirkón“



objednávacie číslo	ø kotúča (mm)	ø otvoru (mm)	zrornosť	Max. otáčky (min <sup>-1</sup> )	model	cena s DPH
P-65458	115	22,2	40	13 300	115 mm uhlové brúsky	2,78 €
P-65464	115	22,2	60	13 300	115 mm uhlové brúsky	2,79 €
P-65470	115	22,2	80	13 300	115 mm uhlové brúsky	2,79 €
P-65486	115	22,2	120	13 300	115 mm uhlové brúsky	2,79 €
P-65492	125	22,2	40	12 000	125 mm uhlové brúsky	3,33 €
P-65501	125	22,2	60	12 000	125 mm uhlové brúsky	3,33 €
P-65517	125	22,2	80	12 000	125 mm uhlové brúsky	3,33 €
P-65523	125	22,2	120	12 000	125 mm uhlové brúsky	3,34 €
P-65539	150	22,2	40	10 200	150 mm uhlové brúsky	5,07 €
P-65545	150	22,2	60	10 200	150 mm uhlové brúsky	5,08 €
P-65551	150	22,2	80	10 200	150 mm uhlové brúsky	5,06 €
P-65567	150	22,2	120	10 200	150 mm uhlové brúsky	5,22 €
P-65573	180	22,2	40	8 600	180 mm uhlové brúsky	7,20 €
P-65589	180	22,2	60	8 600	180 mm uhlové brúsky	7,74 €
P-65595	180	22,2	80	8 600	180 mm uhlové brúsky	7,06 €
P-65604	180	22,2	120	8 600	180 mm uhlové brúsky	7,61 €

## Lamelový kotúč na ušľachtilú oceľ „Zirkón“



objednávacie číslo	ø kotúča (mm)	ø otvoru (mm)	zrornosť	Max. otáčky (min <sup>-1</sup> )	ks/bal	cena s DPH
B-53920	125	22,23	40	12200	1	7,44 €
B-53936	125	22,23	60	12200	1	7,44 €
B-53942	125	22,23	80	12200	1	7,44 €



# Lamelové brúsne kotúče na kameň

Brúsne zrna z karbidu kremíka má tvrdú štruktúru s ostrými hranami a je vhodné najmä na brúsenie tvrdých a húževnatých materiálov s nízkou pevnosťou v ťahu.

Brúsne listy kotúča majú vejárovité usporiadanie, navzájom sa prekrývajú a sú upevnené na vysokokvalitnom kotúči s vláknami zo sklolaminátu.

Najdôležitejšie prednosti lamelových brúsnych kotúčov: vysoký a konštantný úberový výkon, studený výbrus; vysoká kvalita povrchu; dlhá životnosť; nízka hlučnosť.

Oblasti využitia: znášanie hrán; výbrus plôch; brúsenie hrán; finálny výbrus.

Vhodný materiál: kameň; sklo; keramika; plasty.

## Lamelový brúsny kotúč „Karbíd kremíka“



objednávacie číslo	ø kotúča (mm)	ø otvoru (mm)	zrinitosť	Max. otáčky (min <sup>-1</sup> )	model	cena s DPH
P-65296	115	22,2	40	13 300	115 mm uhlové brúsky	2,86 €
P-65305	115	22,2	60	13 300	115 mm uhlové brúsky	2,72 €
P-65311	115	22,2	80	13 300	115 mm uhlové brúsky	2,72 €
P-65327	115	22,2	120	13 300	115 mm uhlové brúsky	2,76 €
P-65333	125	22,2	40	12 000	125 mm uhlové brúsky	3,28 €
P-65349	125	22,2	60	12 000	125 mm uhlové brúsky	3,30 €
P-65355	125	22,2	80	12 000	125 mm uhlové brúsky	3,27 €
P-65361	125	22,2	120	12 000	125 mm uhlové brúsky	3,27 €
P-65377	150	22,2	40	10 200	150 mm uhlové brúsky	4,96 €
P-65383	150	22,2	60	10 200	150 mm uhlové brúsky	4,96 €
P-65399	150	22,2	80	10 200	150 mm uhlové brúsky	5,29 €
P-65408	150	22,2	120	10 200	150 mm uhlové brúsky	5,31 €
P-65414	180	22,2	40	8 600	180 mm uhlové brúsky	6,84 €
P-65420	180	22,2	60	8 600	180 mm uhlové brúsky	8,14 €
P-65436	180	22,2	80	8 600	180 mm uhlové brúsky	8,14 €
P-65442	180	22,2	120	8 600	180 mm uhlové brúsky	8,14 €





## Fíbrové brúsne listy

Brúsny list so zrnom z korundu, upevneným na fíbrovej podložke pomocou pojiva zo syntetickej živice. Podložka je vyrobená z mimoriadne pevnej tkaniny zo sklenených vlákien. Používa sa s elastickým brúsnym tanierom.

Oblasti využitia: odhrdzovanie a čistenie kovových povrchov; výbrus starých lakov a podkladových vrstiev; zarovnávanie zvarov a zahladzovanie, výbrus hrán; odstraňovanie okovín a výbrus nádrží a prístrojov

### Fíbrový brúsny list „Korund“



objednávacie číslo	ø kotúča (mm)	ø otvoru (mm)	zrניות	ks/bal.	model	cena s DPH
P-00860	115	13,0	24	5	115 mm uhlové brúsky	4,31 €
P-00876	115	13,0	36	5	115 mm uhlové brúsky	4,31 €
P-00882	115	13,0	40	5	115 mm uhlové brúsky	4,31 €
P-00898	115	13,0	50	5	115 mm uhlové brúsky	4,31 €
P-00907	115	13,0	60	5	115 mm uhlové brúsky	4,31 €
P-00913	115	13,0	80	5	115 mm uhlové brúsky	4,31 €
P-00929	115	13,0	100	5	115 mm uhlové brúsky	4,31 €
P-00957	125	13,0	24	5	125 mm uhlové brúsky	5,09 €
P-00963	125	13,0	36	5	125 mm uhlové brúsky	5,09 €
P-00979	125	13,0	40	5	125 mm uhlové brúsky	5,09 €
P-00985	125	13,0	60	5	125 mm uhlové brúsky	5,09 €
P-00991	125	13,0	80	5	125 mm uhlové brúsky	5,09 €
P-01002	125	13,0	100	5	125 mm uhlové brúsky	5,09 €
P-01018	125	13,0	120	5	125 mm uhlové brúsky	5,09 €
P-01024	180	13,0	16	5	180 mm uhlové brúsky	7,70 €
P-01030	180	13,0	24	5	180 mm uhlové brúsky	6,63 €
P-01046	180	13,0	36	5	180 mm uhlové brúsky	6,63 €
P-01052	180	13,0	40	5	180 mm uhlové brúsky	6,63 €
P-01068	180	13,0	50	5	180 mm uhlové brúsky	6,63 €
P-01074	180	13,0	60	5	180 mm uhlové brúsky	6,63 €
P-01080	180	13,0	80	5	180 mm uhlové brúsky	6,63 €
P-01096	180	13,0	100	5	180 mm uhlové brúsky	6,63 €
P-01105	180	13,0	120	5	180 mm uhlové brúsky	6,63 €

### Elastický brúsny tanier na uhlové brúsky na používanie fíbrových kotúčov



objednávacie číslo	ø kotúča (mm)	model	cena s DPH
P-05882	115	115 mm uhlové brúsky	4,75 €
P-05898	125	125 mm uhlové brúsky	5,11 €
P-05907	150	150 mm uhlové brúsky	8,28 €
P-05913	180	180 mm uhlové brúsky	7,56 €

# PRÍSLUŠENSTVO

## Multi Tool



Karbid z volfrámu, #30



Karbid z volfrámu, #30



Diamantové zrno, #40



Zúbkovaná hrana



Ostrá hrana



Ostrá hrana



Delta doska



Brúsna doska



# Príslušenstvo pre Multitool

## Segmentový pílový kotúč



objednávacie číslo	použitie	ø (mm)	materiál	cena s DPH
B-64973	neželezné kovy, FRP, PVC, vhodné na rezenia v rohoch	85	BiM-TiN	22,72 €
B-64808	drevo, kov, vhodné na hlboké rezy	100	Bi-Metal	22,16 €
B-64799	drevo, kov, vhodné na priame rezy	85	Bi-Metal	17,50 €
B-64836	drevo, vhodné na priame rezy	85	HCS	12,93 €

## Segmentový pílový kotúč s tvrdokovom



objednávacie číslo	použitie	ø (mm)	materiál	cena s DPH
B-65028	rezanie špár	85	HM zrno #30	25,13 €
B-65040	rezanie tenkých špár (1,6 mm)	65	HM zrno #50	20,20 €
B-65034	rezanie špár, kachličiek a FRP	85	Diamant zrno #40	41,22 €



# Príslušenstvo pre Multitool

## Rezné nástroje



objednávacie číslo	použitie	∅ (mm)	materiál	cena s DPH
B-64820	drevo, klince, vhodné pre ponorné rezy	65 × 40	Bi-Metal	16,65 €
B-64814	drevo, kov, vhodné pre hlboký rez do dreva	28 × 50	Bi-Metal	12,93 €
B-64870	tvrdé drevo	32 × 40	Bi-Metal	12,93 €
B-64858	drevo	32 × 40	HCS	9,86 €
B-64842	drevo	20 × 30	HCS	8,16 €
B-64939	kov, vhodné pre priamy rez klincov alebo rúrok	32 × 30	Bi-Metal	12,96 €
B-64923	kov, vhodné pre priamy rez klincov alebo rúrok	20 × 20	Bi-Metal	9,89 €
B-64917	kov, vhodné pre priamy rez klincov alebo sadrokartónu	10 × 20	Bi-Metal	7,61 €

## Nástroje na odstraňovanie vrstiev materiálu



objednávacie číslo	použitie	∅ (mm)	materiál	cena s DPH
B-64989	odstraňovanie malty, lepidla na kachličky	52 × 26	HCS	7,61 €
B-64995	vhodné na odstraňovanie lepidiel na koberce alebo silikónu	52 × 45	HCS	7,61 €



# Príslušenstvo pre Multitool

## Rezné nože

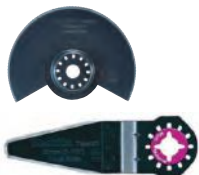

objednávacie číslo	použitie	ø (mm)	materiál	cena s DPH
B-64967	polystyrén, guma, izolačný materiál	100 Ø (mm)	BiM	24,77 €
B-65006	tmel, silikón	28 × 50	HCS	14,39 €

## Rezný nástroj



objednávacie číslo	použitie	ø (mm)	materiál	cena s DPH
B-65078	odstraňovanie omietok a malty, rezanie špár (dlažby)	70	HM zrno #40	36,30 €

## Brúsny tanier



objednávacie číslo	použitie	ø (mm)	materiál	cena s DPH
B-65062	odstraňovanie malty, lepidla na kachličky	78	HM zrno #30	19,81 €



objednávacie číslo	použitie	ø (mm)	materiál	cena s DPH
B-65084	fibrové sklo, malta	30 × 32	HM	20,33 €
B-64967	linoleum, koberce, guma	100 Ø (mm)	BiM	24,77 €
B-64814	Bi-metal rezný nástroj	32 × 70 mm	drevo, kov	12,93 €
B-64858	HCS rezný nástroj	32 × 70 mm	drevo	9,86 €
B-64864	HCS rezný nástroj	65 × 40 mm	drevo	12,83 €
B-65012	HCS rezný nástroj	32 mm	koberce, lino	16,84 €





# Príslušenstvo pre Multitool

## Drevo / Long Life

Vhodné na brúsenie dreva, tvrdého dreva, drevotriesky, stavebného dreva alebo kovu



objednávacie číslo	rozmer (mm)	zrnitost	ks/bal.	cena s DPH
P-33261	93	60	10	2,81 €
P-33277	93	80	10	2,77 €
P-33283	93	100	10	2,71 €
P-33299	93	120	10	2,71 €
P-33314	93	180	10	2,71 €
P-33320	93	240	10	2,71 €
B-21559	93	60,80,100,120,180 (2 ks z každého)	10	2,81 €

## Farba

Vhodné na brúsenie farieb a lakov



objednávacie číslo	rozmer (mm)	zrnitost	ks/bal.	cena s DPH
P-42690	93	60	10	2,74 €
P-42709	93	80	10	2,74 €
P-42715	93	100	10	2,68 €
P-42721	93	120	10	2,68 €
P-42759	93	240	10	2,68 €
P-42765	93	320	10	2,61 €
B-21674	93	60,80,100,240,320 (2 ks z každého)	10	2,71 €

## Kameň

Vhodné na hrubé obrúsenie extrémne tvrdých materiálov napríklad kameňa alebo skla



objednávacie číslo	rozmer (mm)	zrnitost	ks/bal.	cena s DPH
B-21749	93	120	10	2,74 €
B-21755	93	240	10	2,71 €
B-21761	93	400	10	2,68 €
B-21777	93	600	10	2,64 €
B-21783	93	1200	10	2,64 €
B-21733	93	120,240,400,600,1200 (2 ks z každého)	10	2,71 €

## Fleece

Vhodné na obrusovanie hrdzavých plôch alebo nečistôt z dreva



objednávacie číslo	rozmer (mm)	zrnitost	ks/bal.	cena s DPH
B-21799	93	100	1	1,57 €
B-21808	93	280	1	1,57 €
B-21814	93	bez brusiva	1	1,60 €

## Leštenie

Vhodné na leštenie veľmi nečistých alebo poškrábaných povrchov.



objednávacie číslo	rozmer (mm)	zrnitost	ks/bal.	cena s DPH
B-21820	93	tvrdý	1	1,66 €



# Príslušenstvo pre Multitool

Brúsenie a leštenie rôznych materiálov



## Sady

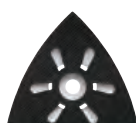

objednávacie číslo	zrinitosť	vhodné pre stroj	cena s DPH
B-65115	brúsny papier Delta (suchý zips), použiteľné so špeciálnou doskou		10,15 €
195965-0		BTM50	5,67 €
196022-7	odsávací nadstavec voliteľné príslušenstvo pre spoľahlivé odsávanie prachu	TM3000C	4,05 €
196550-2		TM3010C	7,26 €
196271-6	adaptér pre príslušenstvo Fein		4,67 €

objednávacie číslo	popis	obsah	cena s DPH
B-67496	sada príslušenstva na prácu s obkladačkami	B-64923 – 1ks B-65028 – 1ks B-64989 – 1ks B-65062 – 1ks	56,21 €
B-67505	sada príslušenstva na prácu s podlahami	B-64995 – 1ks B-64858 – 1ks B-64820 – 1ks B-64799 – 1ks	45,17 €
B-67480	sada príslušenstva na prácu s podlahou	B-64814 – 1ks B-64870 – 1ks B-64923 – 1ks B-64799 – 1ks	46,81 €
B-67511	sada príslušenstva na prácu s drevom	B-46202 – 2ks B-64814 – 1ks B-64870 – 1ks B-64799 – 1ks	55,13 €



# PRÍSLUŠENSTVO

▣ Brúsne kefy



# Príslušenstvo

## Brúsne kefy



### Typ kefy



Oceľový drôt s priemerom 0,3 mm  
Ideálny na odstraňovanie hrdze a náterov.



Nylonová (#80)  
Ideálna na odstraňovanie farieb z kovu, dreva a pvc.



Nylonová (#240)  
Ideálna na povrchovú úpravu kovov, dreva a PVC.

### Typ kefy



Miskovitá  
Pre rovné plochy.



Kotúčová  
Pre úzke miesta.



Štetcovitá  
Pre úzke miesta.



Lopatková  
Pre ošetrovanie povrchu dreva.

AA : odporúčané

Typ kefy			
	Oceľový drôt s priemerom 0,3 mm	Nylónová (#80)	Nylónová (#240)
Drevo 		AA	AA
PVC 		AA	AA
Metal 	AA	AA	AA
Opracovanie (kovový povrch)			 dobrúsené po nylonovej kefe (#80)



# Kefy z ocelového drôtu

## Miskovitá kefa z ocelového drôtu – spletaný drôt

18 spletaných vretien, s vnútorným závitom M 14

Univerzálna kefa na opracúvanie kovov. Kefa s vretienami zo spletaného drôtu je ideálna na náročné, ťažké kefovanie.



objednávacie číslo	ø kefy (mm)	počet vretien	max. otáčky (min <sup>-1</sup> )	model	cena s DPH
P-04488	65	18	12 500	115 / 125 / 150 mm uhlové brúsky	11,70 €

## Miskovitá kefa z ocelového drôtu – spletaný drôt

26 spletaných vretien, s vnútorným závitom M 14

Univerzálna kefa na opracúvanie kovov. Kefa s vretienami zo spletaného drôtu je ideálna na náročné, ťažké kefovanie.



objednávacie číslo	ø kefy (mm)	počet vretien	max. otáčky (min <sup>-1</sup> )	model	cena s DPH
P-04472	100	26	8 500	180 / 230 uhlové brúsky	22,80 €

## Kuželovitá kefa z ocelového drôtu – spletaný drôt

18 spletaných vretien, s vnútorným závitom M 14

Kuželovitá kefa je vďaka svojmu tvaru vhodná najmä na opracúvanie ťažkopristupných miest (hrany, drážky).



objednávacie číslo	ø kefy (mm)	počet vretien	max. otáčky (min <sup>-1</sup> )	model	cena s DPH
P-04494	100	18	12 500	180 / 230 uhlové brúsky	14,97 €

Oblasti využitia kief z ocelového drôtu:

odstraňovanie lakov, okovín, hrdze, trosky  
odstraňovanie zvyškov betónu a tmelov/stierky  
zahladzovanie a začisťovanie zvarov  
príprava kovových povrchov pred lakovaním

Mimoriadne prednosti:

vysoká tuhosť drôtených vretien, vďaka tomu majú kefy vysoký úberový výkon  
húževnaté, veľmi vysoká pevnosť v ťahu  
umožňujú vysoké otáčky  
kuželovitý tvar kefy uľahčuje kefovanie na ťažko prístupných miestach (vnútorné hrany, ryhy, drážky)





# Kefy z oceleového drôtu

Miskovitá kefa z masadného drôtu – vlnitý drôt, M14



objednávacie číslo	ø kefy (mm)	cena s DPH
D-39746	60	3,04 €
D-39768	75	3,42 €
D-39780	90	4,63 €
D-39805	100	5,61 €

Miskovitá kefa z oceleového drôtu – vlnitý drôt, M14



objednávacie číslo	ø kefy (mm)	cena s DPH
D-39827	100	3,96 €
D-39849	115	4,52 €

Miskovitá kefa z oceleového drôtu – vlnitý drôt, M14



objednávacie číslo	ø kefy (mm)	cena s DPH
D-39861	100	4,40 €
D-39883	115	5,01 €

Miskovitá kefa z oceleového drôtu



objednávacie číslo	ø kefy (mm)	cena s DPH
D-40004	12 × 6	1,31 €
D-40010	19 × 6	1,60 €
D-40026	25 × 6	1,93 €
D-40032	30 × 6	2,02 €

Miskovitá kefa z oceleového drôtu



objednávacie číslo	ø kefy (mm)	cena s DPH
D-39908	38 × 6	1,44 €
D-39914	50 × 6	1,64 €
D-39920	63 × 6	1,69 €
D-39936	75 × 6	2,16 €
D-39942	80 × 6	2,45 €

Miskovitá kefa z oceleového drôtu



objednávacie číslo	ø kefy (mm)	cena s DPH
D-39958	38 × 6	1,42 €
D-39964	50 × 6	1,43 €
D-39970	63 × 6	1,68 €
D-39986	75 × 6	1,75 €
D-39992	100 × 6	2,04 €



# Kefy z oceleového drôtu

## Miskovitá kefa z oceleového drôtu – vlnitý drôt, M14



objednávacie číslo	ø kefy (mm)	ø drôtu (mm)	max. otáčky (min <sup>-1</sup> )	model	cena s DPH
D-24072	60	0,3	12 500	125 / 150 mm Uhlová brúska	3,14 €
D-24094	75	0,3	12.500		3,78 €
D-29284	100	0,3	8.500	180 / 230 mm Uhlová brúska	5,43 €

## Miskovitá kefa z oceleového drôtu – spletaný drôt, M14



objednávacie číslo	ø kefy (mm)	ø drôtu (mm)	max. otáčky (min <sup>-1</sup> )	model	cena s DPH
D-24119	60	0,5	12 500	125 / 150 mm Uhlová brúska	5,12 €
D-24131	75	0,5	12.500		5,40 €

## Miskovitá kefa z oceleového drôtu – spletaný drôt, M14



objednávacie číslo	ø kefy (mm)	ø drôtu (mm)	max. otáčky (min <sup>-1</sup> )	model	cena s DPH
D-24153	60	0,5	12 500	125 / 150 mm Uhlová brúska	5,89 €
D-29290	100	0,5	8.500	180 / 230 mm Uhlová brúska	9,47 €

## Miskovitá kefa z oceleového drôtu – spletaný drôt, M14



objednávacie číslo	ø kefy (mm)	ø drôtu (mm)	max. otáčky (min <sup>-1</sup> )	model	cena s DPH
D-29555	100	0,5	12 500	125 / 150 / 180 / 230 mm Uhlová brúska	4,95 €
D-29561	115	0,5	12.500		5,92 €
D-29577	125	0,5	12.500		7,09 €
D-45761	150	0,5	8.500	150 mm – Uhlová brúska	8,89 €
D-45777	175	0,5	8.500	180 mm – Uhlová brúska	10,68 €

# Kefy nylónové pre vrtačky

## miskovitá



objednávacie číslo	ø kefy (mm)	zrornosť	hrúbka drôtu (mm)	cena s DPH
D-45559	75	jemný (#240)	6	5,39 €
D-45543	63	jemný (#240)	6	4,77 €
D-45537	50	jemný (#240)	6	3,29 €
D-45521	75	hrubý (#80)	6	5,39 €
D-45515	63	hrubý (#80)	6	4,77 €
D-45509	50	hrubý (#80)	6	3,29 €

## kotúčová



objednávacie číslo	ø kefy (mm)	zrornosť	hrúbka drôtu (mm)	cena s DPH
D-45618	38	jemný (#240)	6	2,52 €
D-45624	50	jemný (#240)	6	3,14 €
D-45630	63	jemný (#240)	6	3,64 €
D-45646	75	jemný (#240)	6	4,77 €
D-45652	100	jemný (#240)	6	5,39 €
D-45565	38	hrubý (#80)	6	2,52 €
D-45571	50	hrubý (#80)	6	3,14 €
D-45587	63	hrubý (#80)	6	3,64 €
D-45593	75	hrubý (#80)	6	4,77 €
D-45602	100	hrubý (#80)	6	5,39 €

## štetcovitá



objednávacie číslo	ø kefy (mm)	zrornosť	hrúbka drôtu (mm)	cena s DPH
D-45705	12	jemný (#240)	6	2,01 €
D-45711	19	jemný (#240)	6	2,64 €
D-45727	25	jemný (#240)	6	2,96 €
D-45733	30	jemný (#240)	6	4,41 €
D-45668	12	hrubý (#80)	6	2,01 €
D-45674	19	hrubý (#80)	6	2,64 €
D-45680	25	hrubý (#80)	6	2,96 €
D-45696	30	hrubý (#80)	6	4,41 €







## lopatková



objednávacie číslo	ø kefy (mm)	zrornosť	hrúbka drôtu (mm)	cena s DPH
D-45755	100	jemný	6	5,83 €
D-45749	100	hrubý	6	5,83 €



# Príruby na uhlové brúsky

objednávacie číslo	popis	model	cena s DPH	
	192227-7	superpríruba	ø 115–230 mm	12,68 €
	196297-8	supermatica	ø 115–230 mm	16,12 €
	195354-9	špeciálna príruba EZYNUT	ø 180-230 mm M14	55,14 €
	224415-9	upínacia príruba	ø 115–230 mm	1,53 €
	224554-5	prírubová matica	ø 115 / 125 / 150 mm	2,04 €
	224543-0		ø 180 / 230 mm	2,20 €



# Príslušenstvo pre uhlové brúsky



objednávacie číslo	popis	model	cena s DPH
782423-1	kolíkový kľúč	GA4530, 9557HN, GA5030, 9558HN, 9565PCV, GA5021/C, GA6021/C,	1,43 €
197610-3	kolíkový kľúč	9564H, 9565H, 9562CR/CVR, 9565CR/CVR, 9566CR/CVR, GA7010C, GA7020/F/RF, GA7030RF01, GA7040RF01, GA9010C, GA9020/F, GA9020RF, 9079SF, GA9030/R/RF01, GA9040R/RF01,	2,09 €
782401-1	kolíkový kľúč	PC1100	1,13 €
153489-2	rukoväť M8		1,40 €
151776-3	rukoväť M14		10,51 €
152539-0			2,39 €
194514-0	antivibračná rukoväť M8		15,60 €
162264-5	antivibračná rukoväť M14		15,47 €
194684-5	bočná rukoväť pre lepšie ťažisko pri rezaní		12,07 €
195385-8	odsávací kryt (180 mm)		66,34 €
195239-9	odsávací kryt (115–125 mm)		50,71 €
193794-5	kryt kotúča s odsávacím adaptérom (125 mm)		138,65 €
194044-1	kryt kotúča s odsávacím adaptérom (230 mm)		234,20 €
196845-3	kryt kotúča s odsávacím adaptérom (125 mm)		86,00 €
193956-5	ochranný kryt proti prachu	GA5021/GA5021C/GA6021/GA6021C/GA7010C/GA9010C	7,25 €
194289-1	ochranný kryt proti prachu	GA7020, GA9020, GA7030/S, GA7040S, GA9030/S, GA9040S	2,61 €
195446-4	ochranný kryt proti prachu	9565PCV	10,50 €
198440-5	adaptér odsávania	uhlové brúsky (230 mm)	121,78 €

# Príslušenstvo pre uhlové brúsky

## Kryty kotúčov



1 – otvorený kryt s výmenou na kľúč



2 – otvorený kryt s beznástrojovou výmenou



3 – zatvorený kryt s beznástrojovou výmenou

model	obj. číslo 1	cena s DPH	obj. číslo 2	cena s DPH	obj. číslo 3	cena s DPH
9557HN/HNR	123098-1	5,44 €	123144-0	9,55 €	122642-1	3,45 €
9558HN/HNR						
9562CR	123099-9	6,36 €	135108-2	5,32 €	122911-0	5,77 €
9562CVR						
9564H	123098-1	5,44 €	123144-0	9,55 €	122910-2	5,57 €
9565CR						
9565CVR	123099-9	6,36 €	135108-2	5,32 €	122911-0	5,77 €
9565H						
9565PCV						
9566CR	135192-7	6,78 €	123146-6	10,82 €	165744-0	10,36 €
BGA/DGA450	123098-1	5,44 €	123144-0	9,55 €	122910-2	5,57 €
BGA/DGA452						
DGA504	123099-9	6,36 €	123145-8	7,53 €	122911-0	5,77 €
DGA506						
GA4530						
GA4530R						
GA4540						
GA4540C01	123098-1	5,44 €	123144-0	9,55 €	122910-2	5,57 €
GA4540R						
GA4541C01						
GA4541R						
GA4541X01						
GA5021	123099-9	6,36 €	135108-2	5,32 €	122911-0	5,77 €
GA5021C						
GA5030	123099-9	6,36 €	123145-8	7,53 €	122911-0	5,77 €
GA5030R						
GA5040						
GA5040C01						
GA5040R	123099-9	6,36 €	123145-8	7,53 €	122911-0	5,77 €
GA5041C01						
GA5041R						
GA5041X01						
GA6021	135192-7	6,78 €	123146-6	10,82 €	165744-0	10,36 €
GA6021C						
GA6040C01						
GA7010C						
GA7020						
GA7020F						
GA7020RF	122889-7	8,27 €	122846-5	9,87 €	122914-4	15,96 €
GA7030RF01						
GA7040RF01						
GA7060R						
GA7061R						
GA9010C						
GA9020						
GA9020F						
GA9020RF						
GA9020RFK						
GA9030						
GA9030R						
GA9030RF01						
GA9030X01	122891-0	11,49 €	122847-3	11,40 €	122913-6	4,46 €
GA9040R						
GA9040RF01						
GA9050						
GA9050R						
GA9060R						
GA9061R						
GA9062R						
GA9063R						











## Ochranné okuliare



objednávacie číslo	obsah balenia	cena s DPH
P-66363*	1 ks okuliare ochranné púzdro štipule do uší šnúrka čistiaca handrička	16,01 €
P-66329*	1 ks okuliare ochranné púzdro štipule do uší šnúrka čistiaca handrička	15,95 €
P-66341*	1 ks okuliare ochranné púzdro štipule do uší šnúrka čistiaca handrička	19,94 €
P-66307*	1 ks okuliare ochranné púzdro štipule do uší šnúrka čistiaca handrička	15,57 €
P-66385*	1 ks okuliare ochranné púzdro štipule do uší šnúrka čistiaca handrička	15,62 €
192219-6	ochranné okuliare	3,00 €
AL00000147	ochranné okuliare	3,09 €

\* do vypredania zásob

# Príslušenstvo ku hoblíkom

popis	objednávacie číslo	KP0800	KP0810/C	1902	1806B	1911B	NI923B	1923H	KP312S	cena s DPH
 nôž z rýchloreznej ocele (pár)	A-83571	•	•	•			•	•		13,52 €
	D-16346	•	•	•			•	•		6,51 €
	793008-8					•				15,01 €
	D-63666				•					23,11 €
 nôž 8 mm s tvrdokovom (pár)	D-07967	•	•	•			•	•		16,07 €
	D-08822					•				24,13 €
obojstranný nôž z tvrdokovu 2 ks	D-07945	•	•	•			•	•		9,93 €
obojstranný nôž z tvrdokovu 10 ks	D-35302	•	•	•			•	•		47,69 €
obojstranný nôž z rýchloreznej ocele (pár)	B-02870								•	42,90 €
 obojstranný nôž s doštičkou (pár)	D-07951	•	•	•			•	•		12,10 €
 prítlačná doštička (1 ks)	A-86175	•	•	•			•	•		3,77 €
	345328-2								•	26,61 €
 mierka na nastavenie noža	123062-2	•	•	•		•	•	•		2,57 €
 trojuholník na nastavenie noža	762001-3				•				•	0,56 €
 držiak noža na brúsenie	123004-6	•	•	•			•	•		2,82 €
	123055-9					•				3,20 €
	123006-2				•					6,10 €
 obťahovací kameň	794061-7	•	•	•		•	•	•		11,52 €
	794060-9				•					13,23 €
 stacionárny prípravok	STEX122338							•		82,97 €

# Príslušenstvo ku hoblíkom



popis	objednávacie číslo	KP0800	KP0810/C	1902	1806B	1911B	N1923B	1923H	KP312S	KP0800/ DKP180	cena s DPH
paralelný doraz	165581-2	•									4,68 €
	122785-9		•								9,16 €
	123053-3				•						11,08 €
	164371-0			•		•					7,19 €
	165259-7							•	•		8,71 €
	165581-2									•	4,68 €
vedenie bočnej hrany	122791-4	•	•								32,00 €
zariadenie na odvádzanie triesok	JPA122194						•				9,92 €
adaptér na odsávaciu hadicu	152122-3						•				3,94 €
	122397-8				•						62,29 €
	414468-8					•					2,73 €
	416368-8	•	•								2,10 €
	192065-7							•			5,71 €
	193733-5								•		39,90 €
adaptér na odsávaciu hadicu ø 45 mm	181575-9				•				•		6,14 €
	451329-1	•									1,57 €
	JPA122275			•		•	•	•			5,68 €
vak na prach	STEX122269			•							43,69 €
	196300-5					•					33,32 €
	122230-4						•				60,56 €
	196298-6							•			38,21 €
	122793-0	•	•								20,89 €
uhlový adaptér	416368-8	•	•							2,10 €	
plastový kufřík	P-72366						•				68,48 €
	824892-1	•									17,52 €
	824786-0		•								42,98 €



# Príslušenstvo ku preťahovačke 2012NB

	objednávacie číslo	popis	cena s DPH
	793346-8	nôž z rýchloreznej ocele 306 mm (pár)	43,08 €
	782203-5	nástrčkový kľúč 9 mm	2,36 €
	762014-4	držiak s magnetom	4,20 €
	793350-7	nôž štandard 306 mm (pár)	84,99 €
	343692-5	nastaviteľná doska pre nôž štandard	7,50 €
	922103-9	skrutka m4 × 4 pre nôž štandard	0,26 €
	762016-0	mierka pre nastavenie noža štandard	3,49 €
	193036-7	odsávací nástavec (bez možnosti pripojenia k vysávačom Makita)	24,17 €
	194053-0	stôl	113,09 €





# Pílové kotúče

Sortiment príslušenstva Makita je vyladenou zmesou zloženou z preverených výrobkov a nápaditých inovácií, dôkladne vybraných tak, aby vyhovovali náročným potrebám profesionálnych užívateľov.

I keď je príslušenstvo Makita konštruované obzvlášť pre použitie s kvalitným náradím firmy Makita, väčšina z nich rovnako účinne rozširuje možnosti pri práci s náradím iných značiek.

## Sortiment TCT pílových kotúčov

Komplexný sortiment TCT pílových kotúčov, ktorých konštrukcia vyhovuje pílam od firmy Makita i mnoho iných výrobcov. Vysoko kvalitnými pílovými kotúčmi firmy Makita vyrobenými z tej najlepšej oceli podľa najprísnejších noriem sa spoľahlivo prevádzajú veľmi presné rezy. Každý zub má perfektne nabrúsené ostrie, ktoré znižuje množstvo malých triesok, čím zaisťuje ostrejšiu a presnejšiu hranu rezu.

Sortiment zahŕňa 5 rôznych typov pílových kotúčov pre ručné a stacionárne náradie.

Makita vyrába vysoko kvalitné príslušenstvo, ktoré v kombinácii s akýmkoľvek profesionálnym náradím vytvorí účinné a spoľahlivé riešenie pre každú prácu.

Mforce sú kotúče s revolučne vyvinutou konštrukciou zubu a dvojitými zubmi pre rýchlejší a čistejší rez.

Makforce je komplexná rada kvalitne vyrobených ručných pílových kotúčov určených pre široké spektrum aplikácií. Majú vysokokvalitné špičky z karbidu wolframu a predĺženú životnosť.

Makblade Plus sú prvotriedne kotúče pre pokosové a stolné píly so špeciálnou konštrukciou zaručujúcou minimálne vibrácie a tichý chod.

Makblade predstavuje radu kotúčov pre pokosové a akumulátorové píly zahŕňajúce všetky obľúbené značky a modely. Kombinujú v sebe čistý presný rez a dlhú životnosť.

Špeciálne kotúče pre zvláštne aplikácie, stroje alebo materiály. Špeciálne konštruované zuby pre rezanie klinev a „hřč“, hliníku a oceli alebo pre akumulátorové píly.

## Ako čítať kódy výrobkov makita

Typ rezu		Priemer listu Ø mm		Vrtanie Ø mm	
C	Hrubý			A	10 mm
S	Stredný			B	15 mm
C	Čistý			C	15,88 mm
X	Extra čistý			D	16 mm
2				E	20 mm
3				F	25,4 mm
0				G	30 mm
2					
4					
G					
L					

Typ pílového kotúča	Špeciálny kotúč	Počet zubov	Zvláštne vlastnosti
MS = Pokosová píla	X = Mforce		L = Laserová štrbina a tichý
CS = Okružná píla	E = zub so zapustenou špičkou		
TS = Stolná píla	A = hliník		
CMS = Akku pokosová píla			
CC = Akku okružná píla			
BSS = BSS610 Li-ion			
CSP = ponorná okružná píla			
MCS = Píla na kov			

PRÍKLADY:  
 MSXF305100GL: pokosová píla – veľmi jemný rez – Ø 305 mm – 100 zubov – vrtanie 30 mm – laserová štrbina a tichý chod  
 CCM15024A: akku kotúčová píla – stredný rez – Ø 150mm – 24 zubov – vrtanie 10 mm  
 TSA20064G: stolná píla – na hliník – Ø 200 mm – 64 zubov – vrtanie 30 mm



# Pílové kotúče



## Pre kotúčové píly

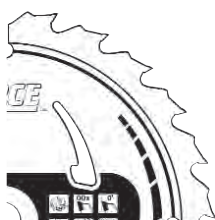

Revolučná zdokonalená konštrukcia zuby, ktorá stanovuje nový medzník v technológii pílových kotúčov. Dvojito zošikmený bok zuby má ostrejšie rezné hrany a tvar M je rovnocenný dvojnásobnému počtu zubov na kotúči. Väčšia trecia plocha a viac rezných plôch má za následok, že kotúč vydrží až 2x dlhšie ako tradičné kotúče.

Rovnaký výsledok s polovicou zubov

Agresívny rez

Väčšia trecia plocha a dlhšia životnosť

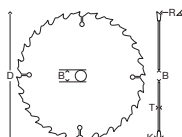

objednávacie číslo	ø kotúča (mm)	ID kód	hrúbka zuby (mm)	vítanie (mm)	počet zubov	hrúbka kotúča (mm)	uhol zuby	ø krúžku (mm)	rez		Max. otáčky (min <sup>-1</sup> )	materiál	cena s DPH
									priečny	pozdĺžny			
B-07886	165	CSCX16510E	2	20	10	1,2	15°		•	•	9 250	drevo	18,78 €
B-07892	165	CSCX16510G	2	30	10	1,2	15°		•	•	9 250	drevo	19,47 €
B-07901	165	CSCX16516E	2	20	16	1,2	15°		•	•	9 250	drevo	19,69 €
B-08006	165	CSCX16524E	2	20	24	1,2	15°		•	•	9 250	drevo	21,60 €
B-07917	170	CSCX17016G	2	30	16	1,2	15°	15,88	•	•	8 980	drevo	15,25 €
B-08012	170	CSMX17024G	2	30	24	1,2	15°	15,88	•	•	8 980	drevo	20,19 €
B-07923	180	CSCX18016E	2	20	16	1,2	15°		•	•	8 480	drevo	20,24 €
B-07939	180	CSCX18016G	2	30	16	1,2	15°		•	•	8 480	drevo	17,72 €
B-08028	180	CSMX18024E	2	20	24	1,2	15°		•	•	8 480	drevo	22,55 €
B-08034	180	CSMX18024G	2	30	24	1,2	15°		•	•	8 480	drevo	21,17 €
B-07945	185	CSCX18516G	2	30	16	1,2	15°	15,88/20	•	•	8 250	drevo	23,09 €
B-08040	185	CSMX18524G	2	30	24	1,2	15°	15,88/20	•	•	8 250	drevo	24,22 €
B-07951	190	CSCX19012C	2	15,88	12	1,2	15°		•	•	8 040	drevo	16,11 €
B-07967	190	CSCX19012G	2	30	12	1,2	15°	15,88/20	•	•	8 040	drevo	21,75 €
B-08056	190	CSMX19024G	2	30	24	1,2	15°	15,88/20	•	•	8 040	drevo	24,74 €
B-08062	190	CSMX19024C	2	15,88	24	1,2	15°		•	•	8 040	drevo	18,52 €
B-07973	210	CSCX21016G	2,3	30	16	1,4	15°		•	•	7 300	drevo	31,06 €
B-08078	210	CSMX21024G	2,3	30	24	1,4	15°		•	•	7 300	drevo	30,61 €
B-08109	210	CSFX21040G	2,3	30	40	1,4	15°		•	•	7 300	drevo	37,65 €
B-07989	230	CSCX23018G	2,3	30	18	1,6	15°		•	•	6 640	drevo	28,54 €
B-08084	230	CSMX23024G	2,3	30	24	1,6	15°		•	•	6 640	drevo	37,32 €
B-08115	230	CSFX23040G	2,3	30	40	1,6	15°		•	•	6 640	drevo	38,88 €
B-07995	235	CSCX23520G	2,3	30	20	1,6	15°	15,88/25	•	•	6 500	drevo	34,54 €
B-08090	235	CSMX23524G	2,3	30	24	1,6	15°		•	•	6 500	drevo	37,79 €
B-08121	235	CSFX23540G	2,3	30	40	1,6	15°	15,88/25	•	•	6 500	drevo	46,70 €



### DLHŠIA ŽIVOTNOSŤ

Zošikmená bočná a horná plocha vytvára 6 rezných hrán, čím výrazne predlžuje životnosť v porovnaní s tradičnými kotúčmi.



### VÄČŠIA RÝCHLOSŤ REZU

Zošikmený bok zuby má dva uhly 10, ktoré vytvárajú agresívnejší a rýchlejší rez.



### ČISTEJŠÍ REZ

Špička tvaru M má viac rezných bodov, čo spôsobuje čistejší rez.

Kotúč s 24 zubami má rovnaký výsledok ako 48 zubov u tradičných kotúčoch.





# Pílové kotúče

**MAKFORCE**

## Pre kotúčové píly



Komplexná rada pílových kotúčov pre všetky značky a modely ručných kotúčových píl. Bohatý výber veľkostí od 140 mm – 355 mm a počtu zubov od 10 – 60 pokrýva možnosti použitia pre hrubé pozdĺžne a priečne rezy až po extra jemné priečne rezy.

Tvrdené a vystužené kotúče absorbujú rázy a zostávajú ploché a rovné.

Výrazné predĺženie životnosti kotúčov vďaka použitiu prvotriedneho karbidu wolframu s pomalým opotrebením.

Úzka rezná špára s menším množstvom odpadu a menším vodiacim tlakom.

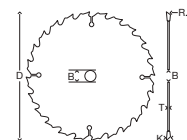

objednávacie číslo	ø kotúča (mm)	ID kód	hrúbka zubu (mm)	vrtanie (mm)	počet zubov	hrúbka kotúča (mm)	uhol zubu	ø krúžku (mm)	rez		Max. otáčky (min <sup>-1</sup> )	materiál	cena s DPH
									priečný	pozdĺžny			
B-08137	140	CSC14018C	1,5	15,88	18	1	20°		•	•	10 910	drevo	28,45 €
B-08280	150	CSM15024E	2,4	20	24	1,5	20°		•	•	10 180	drevo	30,41 €
B-08143	160	CSC16016E	2,4	20	16	1,5	20°	15,88	•	•	9 540	drevo	25,76 €
B-08296	160	CSM16024E	2,4	20	24	1,5	20°	15,88	•	•	9 540	drevo	30,17 €
B-08420	160	CSM16040E	2,4	20	40	1,5	20°	15,88	•	•	9 540	drevo	35,62 €
B-08159	165	CSC16510E	2	20	10	1,4	20°		•	•	9 250	drevo	25,24 €
B-08165	165	CSC16510G	2	30	10	1,4	20°		•	•	9 250	drevo	21,36 €
B-08305	165	CSM16524G	2,4	30	24	1,5	20°		•	•	9 250	drevo	29,15 €
B-08436	165	CSM16540G	2,4	30	40	1,5	20°		•	•	9 250	drevo	34,92 €
B-08171	170	CSC17016G	2,4	30	16	1,5	20°	15,88	•	•	8 980	drevo	23,83 €
B-08311	170	CSM17024G	2,4	30	24	1,5	20°	15,88	•	•	8 980	drevo	22,63 €
B-08442	170	CSM17040G	2,4	30	40	1,5	20°	15,88	•	•	8 980	drevo	29,01 €
B-08193	180	CSC18016G	2,4	30	16	1,5	20°		•	•	8 480	drevo	27,61 €
B-08327	180	CSM18024E	2,4	20	24	1,5	20°		•	•	8 480	drevo	27,70 €
B-08333	180	CSM18024G	2,4	30	24	1,5	20°		•	•	8 480	drevo	26,90 €
B-08458	180	CSM18040E	2,4	20	40	1,5	20s		•	•	8 480	drevo	34,41 €
B-08464	180	CSM18040G	2,4	30	40	1,5	20°		•	•	8 480	drevo	33,00 €
B-08202	185	CSC18516C	1,8	15,88	16	1,2	20°		•	•	8 250	drevo	23,60 €
B-08349	185	CSM18524C	1,8	15,88	24	1,2	20°		•	•	8 250	drevo	33,32 €
B-08470	185	CSM18540C	1,8	15,88	40	1,2	20°		•	•	8 250	drevo	26,91 €
B-08218	190	CSC19012C	2,2	15,88	12	1,4	20°		•	•	8 040	drevo	14,92 €
B-08224	190	CSC19012G	2	30	12	1,4	20°	15,88/20	•	•	8 040	drevo	25,26 €
B-08355	190	CSM19024G	2,2	30	24	1,4	20°	15,88/20	•	•	8 040	drevo	30,17 €
B-08361	190	CSM19024C	2,2	15,88	24	1,4	20°		•	•	8 040	drevo	26,02 €
B-08486	190	CSM19040G	2,2	30	40	1,4	20°	15,88/20	•	•	8 040	drevo	35,99 €
B-08492	190	CSM19040C	2,2	15,88	40	1,4	20°		•	•	8 040	drevo	32,12 €
B-08551	190	CSXF19060G	2,2	30	60	1,4	15°	15,88/20	•	•	8 040	drevo	38,19 €
B-08230	210	CSC21016G	2,4	30	16	1,6	20°		•	•	7 300	drevo	32,56 €
B-08377	210	CSM21024G	2,4	30	24	1,6	20°		•	•	7 300	drevo	37,11 €
B-08501	210	CSM21040G	2,4	30	40	1,6	20°		•	•	7 300	drevo	39,77 €
B-08383	230	CSM23024G	2,3	30	24	1,6	20°		•	•	6 640	drevo	34,93 €
B-08517	230	CSM23040G	2,6	30	40	1,6	20°		•	•	6 640	drevo	45,22 €
B-08567	230	CSXF23060G	2,8	30	60	1,8	15°		•	•	6 640	drevo	46,68 €
B-08252	235	CSC23518G	2,6	30	18	1,6	20°		•	•	6 500	drevo	39,22 €
B-08399	235	CSM23520G	2,3	30	20	1,6	20°		•	•	6 500	drevo	32,31 €
B-08408	235	CSM23524G	2,3	30	24	1,6	20°		•	•	6 500	drevo	38,22 €
B-08523	235	CSM23540G	2,6	30	40	1,6	20°		•	•	6 500	drevo	43,73 €
B-08589	235	CSXF23560G	2,8	30	60	1,8	15°		•	•	6 500	drevo	44,09 €
B-08268	270	CSC27024G	2,6	30	24	1,8	20°		•	•	5 650	drevo	48,17 €
B-08539	270	CSM27040G	2,6	30	40	1,6	20°		•	•	5 650	drevo	63,05 €
B-08573	270	CSXF27060G	2,8	30	60	1,8	15°	20	•	•	5 650	drevo	68,85 €
B-08274	355	CSC35524G	3	30	24	2,2	20°		•	•	4 300	drevo	72,34 €
B-08414	355	CSM35540G	3	30	40	2,2	20°		•	•	4 300	drevo	83,78 €
B-08545	355	CSM35560G	3	30	60	2,2	20°		•	•	4 300	drevo	93,63 €
B-08595	355	CSXF35560G	2,8	30	60	1,8	15°		•	•	4 300	drevo	82,76 €



# Pílové kotúče

Pre pokosové a stolné píly

**MAKBLADE PLUS**

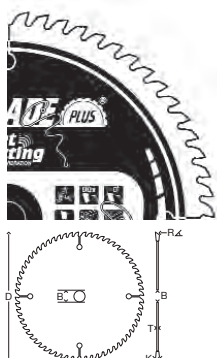

Pílové kotúče Makblade Plus pre pokosové a stolné píly majú jedinečnú patentovanú technológiu. Tieto kotúče sú vyvinuté k pohlienu vibrácií a veľmi tichému chodu. Majú vlastnosti zlepšovať pracovné prostredie, životnosť kotúča a spoľahlivosť celého zariadenia. Kotúč s menšími vibráciami zaistí presnejšie vedenie rezu a tiež znižuje hádzavosť. Výsledným efektom je ideálna rezná plocha. Taktiež má za dôsledok významne dlhšiu životnosť zubov z karbidu wolframu prekračujúcu životnosť konvenčných pílových kotúčov s karbidovými hrotmi.

Presne vystužené kotúče s plochejším ostrím a rovnejším rezom

Povrchová vrstva s veľmi malým trením znamená rezanie bez námahy a ochranu pred koróziou.

objednávacie číslo	ø kotúča (mm)	ID kód	hrúbka zuby (mm)	vrtanie (mm)	počet zubov	hrúbka kotúča (mm)	uhol zuby	ø krúžku (mm)	rez		Max. otáčky (min <sup>-1</sup> )	materiál	cena s DPH
									príčný	pozdĺžny			
B-08604	190	MSC19024EL	2,2	20	24	1,6	5°		•		8 040	drevo	42,85 €
B-08757	190	MSF19060EL	2	20	60	1,4	5°		•		8 040	drevo	67,50 €
B-09802	200	TSM20036GL	2,6	30	36	1,6	20°		•	•	7 630	drevo	52,68 €
B-08822	200	TSF20060GL	2,6	30	60	1,6	15°		•	•	7 630	drevo	100,65 €
B-08610	216	MSC21624GL	2,4	30	24	1,6	5°		•		7 070	drevo	52,88 €
B-08632	216	MSM21648GL	2,4	30	48	1,6	5°		•		7 070	drevo	82,61 €
B-08676	216	MSM21660GL	2,1	30	60	1,6	5°		•		7 070	drevo	73,94 €
B-08791	216	MSXF21680GL	2,8	30	80	1,8	5°		•		7 070	drevo	98,43 €
B-09818	250	TSM25040GL	2,8	30	40	1,8	20°		•	•	6 110	drevo	109,68 €
B-08838	250	TSF25080GL	2,8	30	80	1,8	15°		•	•	6 110	drevo	128,34 €
B-08626	255	MSC25532GL	2,3	30	32	1,8	5°		•		5 990	drevo	77,85 €
B-08648	255	MSM25540GL	2,4	30	40	1,8	5°		•		5 990	drevo	90,82 €
B-08682	255	MSM25560GL	2,3	30	60	1,8	5°		•		5 990	drevo	109,94 €
B-08763	255	MSF25572GL	2,4	30	72	1,8	5°		•		5 990	drevo	92,08 €
B-08654	260	MSM26040GL	2,3	30	40	1,8	5°		•		5 870	drevo	88,54 €
B-09824	260	TSM26040GL	2,8	30	48	1,8	20°		•	•	5 870	drevo	121,18 €
B-08698	260	MSM26060GL	2,3	30	60	1,8	5°		•		5 870	drevo	103,05 €
B-08707	260	MSM26070GL	2,3	30	70	1,8	5°		•		5 870	drevo	93,69 €
B-08779	260	MSF26080GL	2,3	30	80	1,8	5°		•		5 870	drevo	118,60 €
B-08844	260	TSF26080GL	2,8	30	80	1,8	15°		•	•	5 870	drevo	142,04 €
B-08800	260	MSXF260100GL	2,3	30	100	1,8	5°		•		5 870	drevo	108,18 €
B-09830	300	TSM30048GL	2,8	30	48	1,8	20°		•	•	5 090	drevo	102,12 €
B-08850	300	TSF300100GL	2,8	30	100	1,8	15°		•	•	5 090	drevo	130,36 €
B-08660	305	MSM30540GL	2,3	30	40	1,8	5°		•		5 000	drevo	104,85 €
B-08713	305	MSM30560GL	2,3	30	60	1,8	5°		•		5 000	drevo	87,77 €
B-08729	305	MSM30560GLA	2,6	30	60	2	5°		•		5 000	drevo	136,89 €
B-08735	305	MSM30570GL	2,5	30	70	1,9	0°		•		5 000	drevo	104,15 €
B-08785	305	MSF30580GL	2,3	30	80	1,8	5°		•		5 000	drevo	136,14 €
B-08816	305	MSXF305100GL	2,3	30	100	1,8	5°		•		5 000	drevo	134,19 €
B-09846	350	TSM35056GL	3,5	30	56	2,5	20°		•	•	4 360	drevo	124,88 €
B-08866	350	TSF35056GL	3	30	100	2	15°		•	•	4 360	drevo	119,27 €
B-08741	355	MSM35580GL	3	30	80	2,2	5°		•		4 300	drevo	160,57 €



## NÍZKE VIBRÁCIE

Vďaka antivibračnej laserom rezanej drážke.



## TICHÉ REZANIE

Povrchová vrstva s veľmi malým trením. Hlučnosť pílového kotúča je jednou z hlavných nepríjemností na pracovisku. MakBlade plus zaistujú menej hlučné pracovné prostredie.

**Quiet Cutting**  
WITH LESS VIBRATION



# Pílové kotúče



## Špeciálne pílové kotúče EFFICUT

Novo vyvinutý dizajn zubov, najmä pre píly poháňané batériami, chráni batériu a chráni motor. Samozrejme v overenej kvalite Makita!

Nová forma zubov pre vyššiu odolnosť, extra tenké, dokonale vyvážené, vyrobené z ocele pre presný rez. Presné rezné hrany karbidu s novou geometriou pre hladké rezy a dlhú životnosť batérie.

objednávacie číslo	ø kotúča (mm)	hrúbka rezu (mm)	vrtanie (mm)	počet zubov	hrúbka kotúča (mm)	uhol zubu	tvar zubu	max. otáčky (min <sup>-1</sup> )	materiál	cena s DPH
B-62979	165	1,4	20	25	1	23°	ATAFR	9250	drevo	28,64 €
B-57320	165	1,45	20	56	1	23°	ATAFR	9250	drevo, mdf, laminát	48,89 €
B-64185	190	1,45	30	24	1	23°	ATAFR	8040	drevo	31,59 €
B-64624	260	2,15	25,4	45	1,65	10°	ATAFR	5870	drevo	54,74 €

## Špeciálne kotúče na kovy pre aku píly DCS550/551/552/553



objednávacie číslo	ø kotúča (mm)	vrtanie (mm)	počet zubov	max. otáčky (min <sup>-1</sup> )	materiál	cena s DPH
B-46296	150	20	32	4680	kov	34,68 €
B-47008	150	20	52	4680	tenký plech	49,42 €
B-47014	150	20	60	4680	nerez/mäkká oceľ	57,02 €
B-47020	150	20	52	4680	hliník	48,77 €

## Pílové kotúče pre pokosové píly



objednávacie číslo	ø kotúča (mm)	hrúbka zubu (mm)	vrtanie (mm)	počet zubov	hrúbka kotúča (mm)	uhol zubu	Max. otáčky (min <sup>-1</sup> )	materiál	cena s DPH
D-65377	260	2,6	30	40	1,8	15°	5870	drevo	16,45 €
D-65383	260	2,6	30	60	1,8	15°	5870	drevo	19,64 €
D-65399	260	2,6	30	80	1,8	12°	5870	drevo	23,02 €
D-65408	260	2,6	30	100	1,8	12°	5870	drevo	26,11 €

## Pílové kotúče pre kotúčové a pokosové píly



objednávacie číslo	ø kotúča (mm)	hrúbka zubu (mm)	vrtanie (mm)	počet zubov	hrúbka kotúča (mm)	uhol zubu	Max. otáčky (min <sup>-1</sup> )	materiál	cena s DPH
D-64951	190	2,2	30	24	1,4	15°	8040	drevo	7,51 €
D-64973	190	2	30	40	1,3	18°	8040	drevo	11,52 €



# Pílové kotúče

Pre pokosové a stolné píly

**MAKBLADE**

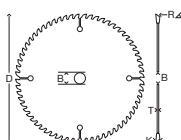

Komplexný výber pílových kotúčov pre všetky značky a modely pokosových píl a ponorných píl vrátane aku píl.

Bohatý výber veľkostí od 190 mm–305 mm a počtu zubov od 24 do 100 pokrýva možnosti použitia od hrubých rezov až po prácu so zvlášť jemnou povrchovou úpravou.

Tvrdené a vystužené kotúče absorbujú rázy a zostávajú ploché a rovné.

Úzka rezná špára s menším množstvom odpadu.

objednávacie číslo	ø kotúča (mm)	ID kód	hrúbka zubu (mm)	vrtanie (mm)	počet zubov	hrúbka kotúča (mm)	uhol zubu	ø krúžku (mm)	rez		Max. otáčky (min <sup>-1</sup> )	materiál	cena s DPH
									priečny	pozdĺžny			
B-08894	190	MSC19024E	2,2	20	24	1,6	5°		•	8 040	Drevo	29,48 €	
B-08953	190	MSM19048E	2,2	20	48	1,6	5°		•	8 040	Drevo	50,26 €	
B-09042	190	MSF19060E	2	20	60	1,4	5°		•	8 040	Drevo	48,37 €	
B-08903	216	MSC21624G	2,4	30	24	1,6	5°		•	7 070	Drevo	37,00 €	
B-08872	216	CMSM21640G	2,1	30	40	1,6	10°		•	7 070	Drevo	61,27 €	
B-08969	216	MSM21648G	2,4	30	48	1,6	5°		•	7 070	Drevo	54,44 €	
B-09058	216	MSF21660G	2	30	60	1,4	5°		•	7 070	Drevo	54,30 €	
B-09092	216	MSXF21680G	2,8	30	100	1,8	5°		•	7 070	Drevo	51,88 €	
B-08919	250	MSC25032G	2,4	30	32	1,6	5°		•	6 110	Drevo	44,05 €	
B-08975	250	MSM25048G	2,4	30	48	1,8	5°		•	6 110	Drevo	54,59 €	
B-09008	250	MSM25060G	2,3	30	60	1,8	5°		•	6 110	Drevo	55,78 €	
B-09064	250	MSF25072G	2,4	30	72	1,8	5°		•	6 110	Drevo	51,13 €	
B-09101	250	MSXF250100G	2,3	30	100	1,8	5°		•	6 110	Drevo	55,58 €	
B-08925	255	MSC25532G	2,3	30	32	1,8	5°		•	5 990	Drevo	69,97 €	
B-08888	255	CMSM25548G	2,1	30	48	1,6	10°		•	5 990	Drevo	65,55 €	
B-09014	255	MSM25560G	2,3	30	60	1,8	5°		•	5 990	Drevo	55,53 €	
B-08931	260	MSC26032G	2,3	30	32	1,8	5°		•	5 870	Drevo	49,58 €	
B-08981	260	MSM26040G	2,3	30	40	1,8	5°		•	5 870	Drevo	38,94 €	
B-09020	260	MSM26060G	2,3	30	60	1,8	5°		•	5 870	Drevo	53,30 €	
B-09070	260	MSF26080G	2,3	30	80	1,8	5°		•	5 870	Drevo	58,66 €	
B-09117	260	MSXF260100G	2,3	30	100	1,8	5°		•	5 870	Drevo	67,27 €	
B-08947	305	MSC30532G	2,3	30	32	1,8	5°		•	5 000	Drevo	56,82 €	
B-08997	305	MSM30540G	2,3	30	40	1,8	5°		•	5 000	Drevo	55,96 €	
B-09036	305	MSM30560G	2,3	30	60	1,8	5°		•	5 000	Drevo	71,85 €	
B-09086	305	MSF30580G	2,3	30	80	1,8	5°		•	5 000	Drevo	82,73 €	
B-09123	305	MSXF305100G	2,3	30	100	1,8	5°		•	5 000	Drevo	94,21 €	
B-46171	315	TSC31528G	2,8	30	28	2,0	20°		•	4850	Drevo	70,37 €	
B-46187	315	TSC31548G	2,8	30	48	2,0	10°		•	4850	Drevo	83,26 €	
B-46193	315	TSC31560G	2,8	30	60	2,0	10°		•	4850	Drevo	93,77 €	
JM27170001	315	TCS31540G	2,8	30	40	2,0	9°		•	4 850	Drevo	34,28 €	



#### MENŠIA NÁMAHA

Úzka rezná špára znižuje namáhanie počas práce a predlžuje predpokladanú životnosť ako stroja, tak kotúča.



#### DLHÁ ŽIVOTNOSŤ

Prvotriedne zuby TCT, pomalé opotrebenie.





# Pílové kotúče

## Špeciálne kotúče pre akku píly

**SPECIALIZED**  
FOR CORDLESS SAWS

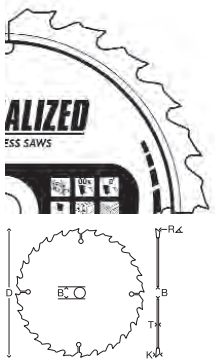

Ušľachtilé pílové kotúče vyrobené špeciálne pre AKKU píly. Ponúkame kotúče na rezanie dreva pomocou všetkých modelov AKKU kotúčových píly v kvalite firmy Makita.

Ultratenké, perfektne vystužené oceľové kotúče pre rovné vedenie. Predlžuje výdrž batérií.

Presne brúsené z prvotriedneho karbidu pre ľahšie, hladšie rezy a dlhú životnosť.

Usporiadanie zubov odpovedá zvláštnym požiadavkám na rezanie.

objednávacie číslo	ø kotúča (mm)	ID kód	hrúbka zubu (mm)	vrtanie (mm)	počet zubov	hrúbka kotúča (mm)	uhol zubu	ø krúžku (mm)	rez		Max. otáčky (min <sup>-1</sup> )	materiál	cena s DPH
									priečny	pozalžný			
B-16885	85	CCF8520B	1	15	20	0,7	10°		•	•	2 240	drevo	10,90 €
B-09139	136	CCM13624A	1,5	10	24	1	20°		•	•	4 500	drevo	22,82 €
B-09210	136	CCF13636A	1,5	10	36	1	18°		•	•	4 500	drevo	36,60 €
B-10643	136	CCC13616E	1,5	20	16	1	20°		•	•		drevo	32,38 €
B-10615	136	MCCS13630E	1,5	20	30	1,2	0°		•	•		kov	58,88 €
B-09145	150	CCM15024A	1,5	10	24	1	20°		•	•	2 500	drevo	27,17 €
B-09226	150	CCF15040A	1,5	10	40	1	18°		•	•	2 500	drevo	29,09 €
B-09151	160	CCC16024E	1,5	20	24	1	20°		•	•	4 770	drevo	24,26 €
D-51079	165	CCC16524E	1,5	20	24	1	20°		•	•	4 770	drevo	9,63 €
B-09173	165	BBS16524E	1,5	20	24	1	20°		•	•	4 770	drevo	26,58 €
B-09189	165	CCC16524E	1,5	10	24	1	20°		•	•	4 770	drevo	14,66 €
B-09232	165	CCF16540E	1,6	20	40	1	18°		•	•	4 770	drevo	29,47 €
B-09248	165	BBS16540E	1,6	20	40	1	18°		•	•	4 770	drevo	30,48 €
B-09195	190	CCC19024G	2	30	24	1,4	20°		•	•	3 000	drevo	31,77 €
B-09254	190	CCM19040G	2	30	40	1,4	10°		•	•	3 000	drevo	38,04 €



### ŠPECIÁLNA KONŠTRUKCIA

Vynikajúce pre Akku píly - predlžuje výdrž batérie a chráni motor.



### ŠIROKÁ MOŽNOSŤ POUŽITIA

Kotúče vhodné pre širokú škálu možného použitia.



### NAJLEPŠÍ POVRCH

Presne brúsené zuby s povrchom ako zrkadlo a ostrejším břitom.

## Pílové kotúče na laminátové dosky

**SPECIALIZED**  
FOR CORDLESS SAWS



objednávacie číslo	ø kotúča (mm)	ID kód	hrúbka zubu (mm)	vrtanie (mm)	počet zubov	hrúbka kotúča (mm)	uhol zubu	ø krúžku (mm)	rez		Max. otáčky (min <sup>-1</sup> )	materiál	cena s DPH
									priečny	pozalžný			
B-29430	85 mm	CCXF8524B	1	15	24	0,7	7°				2240	laminát	17,59 €
B-29446	136 mm	CCXF13648E	1.4	20	48	1	10°				4500	laminát	40,11 €
B-29452	165 mm	CCXF16552EL	1.45	20	52	1	5°				4770	laminát	60,01 €
B-29468	190 mm	MSXF19060GL	2	30	60	1,4	5°				8040	laminát	68,33 €
B-29474	216 mm	MSXF21672GL	2.5	30	72	1,8	5°				7070	laminát	98,21 €
B-29480	250 mm	MSXF25084GL	2.5	30	84	1,8	5°				6110	laminát	134,97 €
B-29496	260 mm	MSXF26084GL	2.5	30	84	1,8	5°				5870	laminát	131,28 €
B-29505	305 mm	MSXF30596GL	2.5	30	96	1,8	5°				5000	laminát	178,80 €



# Pílové kotúče

Špeciálne kotúče pre akku píly – špeciálne zapustené hroty

**SPECIALIZED**  
TIP EMBEDDED  
KNOT AND NAIL CUTTING



Kotúče so zapustenými hrotmi, alebo „hlbokými zubmi“ sú navrhnuté tak, aby vyhovovali pílam Makita i iných výrobcov. Sú to veľmi pevné kotúče odolné proti opotrebovaniu.

Lahko si poradí s „hrčovitým“ drevom a ani rezanie dreva s klincami alebo skrutkami jeho zuby nepoškodí. Sú obzvlášť vhodné pre použitie na stavebné drevo a demolačné práce.

Rezanie klincov a „hrč“.

Extrémne pevný a odolný proti opotrebovaniu.

Dlhšia životnosť a zvýšená produktivita.

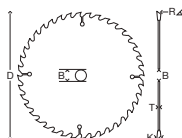

objednávacie číslo	ø kotúča (mm)	ID kód	hrúbka zubu (mm)	vrtanie (mm)	počet zubov	hrúbka kotúča (mm)	uhol zubu	ø krúžku (mm)	rez		Max. otáčky (min <sup>-1</sup> )	materiál	cena s DPH
									priečny	pozdĺžny			
B-09329	165	CSCE16516E	2	20	16	1,25	23°		•	•	9 250	drevo	37,00 €
B-09391	165	CSME16524E	2	20	24	1,25	23°		•	•	9 250	drevo	44,42 €
B-09472	165	CSME16540E	2	20	40	1,25	18°		•	•	9 250	drevo	54,16 €
B-09341	185	CSCE18516G	2	30	16	1,25	25°		•	•	8 250	drevo	22,72 €
B-09400	185	CSME18524C	2	15,88	24	1,25	23°		•	•	8 250	drevo	16,06 €
B-09416	185	CSME18520G	2	30	20	1,25	25°		•	•	8 250	drevo	26,83 €
B-09494	185	CSME18540G	2	30	40	1,25	25°		•	•	8 250	drevo	42,73 €
B-09357	190	CSCE19016G	2	30	16	1,25	23°		•	•	8 040	drevo	28,43 €
B-09422	190	CSME19024G	2	30	24	1,25	23°		•	•	8 040	drevo	34,30 €
B-09503	190	CSME19040G	2	30	40	1,25	23°		•	•	8 040	drevo	45,79 €
B-09363	210	CSCE21018G	1,9	30	18	1,4	23°		•	•	7 300	drevo	32,73 €
B-09438	210	CSME21024G	1,9	30	24	1,4	23°		•	•	7 300	drevo	54,81 €
B-09379	235	CSCE23520G	2,3	30	20	1,6	25°		•	•	6 500	drevo	44,15 €
B-09444	235	CSME23524G	2,3	30	24	1,6	23°		•	•	6 500	drevo	47,25 €
B-09519	235	CSME23548G	2,3	30	48	1,6	18°		•	•	6 500	drevo	64,53 €
B-09450	270	CSME27024G	2,6	30	24	1,8	23°		•	•	5 650	drevo	91,96 €
B-09525	270	CSME27040G	2,6	30	40	1,8	18°		•	•	5 650	drevo	102,14 €
B-09385	355	CSCE35524G	3	30	24	2,2	23°		•	•	4 300	drevo	102,98 €
B-09466	355	CSME35540G	3	30	40	2,2	23°		•	•	4 300	drevo	134,41 €
B-09547	355	CSME35560G	3	30	60	2,2	18°		•	•	4 300	drevo	91,75 €



## CHRÁNENÉ ZUBY

Kotúče so zapustenými hrotmi alebo hlbokými zubmi majú veľmi silnú väzbu medzi telom listu a hrotom TCT.



## VYSOKÉ NÁROKY

Zvlášť vhodné na bednenie a iné náročné práce. Vynikajúce na rezanie dreva s „hrčami“ a klincami.



# Pílové kotúče

Špeciálne kotúče na rezanie hliníka pre kotúčové, pokosové a stolné píly

**SPECIALIZED**  
FOR ALUMINUM CUTTING

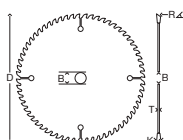

Rada kotúčov pre ručné, pokosové a stolné píly s vynikajúcim rezným výkonom pre hliník, meď, mosadz, bronz a iné farebné kovy. Kotúče sú vhodné aj k práci s plastmi a laminovaným drevom.

Pri rezaní farebných kovov je treba na hroty používať mazivo, aby sa v drážkach kotúča nehromadili triesky.

Presne vystužené kotúče pre plochšie brity a rovnejšie rezy.

Vynikajúca kvalita rezu farebných kovových materiálov.

Špičkový výkon pri laminátových podlahových materiáloch.

objednávacie číslo	ø kotúča (mm)	ID kód	hrúbka zubu (mm)	vrtanie (mm)	počet zubov	hrúbka kotúča (mm)	uhol zubu	ø krúžku (mm)	rez		Max. otáčky (min <sup>-1</sup> )	materiál	cena s DPH
									priečny	pozdĺžny			
B-09553	160	CSA16060E	2,4	20	60	1,8	0°				9 540	hliník	42,95 €
B-09569	160	CSA16060G	2,4	30	60	1,8	0°	20			9 540	hliník	44,17 €
B-09575	180	CSA18060G	2,4	30	60	1,8	0°	15,88/20			8 480	hliník	54,11 €
B-09597	190	CSA19060G	2,4	30	60	1,8	0°	15,88/20			8 040	hliník	66,98 €
B-09612	190	MSA19060E	2	20	60	1,4	-5°				8 040	hliník	54,93 €
B-09690	200	TSA20064G	2,8	30	64	2,2	0°				7 630	hliník	90,15 €
B-09628	216	MSA21664G	2,2	30	64	1,6	-5°				7 070	hliník	65,41 €
B-09606	235	CSA23580G	2,4	30	80	1,8	0°				6 500	hliník	76,65 €
B-09634	250	MSA25080G	2,4	30	80	1,8	-5°				6 110	hliník	74,10 €
B-09709	250	TSA25080G	2,8	30	80	2,2	0°				6 110	hliník	89,73 €
B-09640	250	MSA250100G	2,4	30	100	1,8	-5°				6 110	hliník	72,61 €
B-09656	260	MSA26080G	2,3	30	80	1,8	-5°				5 870	hliník	74,43 €
B-09715	260	TSA26080G	2,8	30	80	2,2	0°				5 870	hliník	100,55 €
B-09662	260	MSA260100G	2,3	30	100	1,8	-5°				5 870	hliník	76,06 €
B-09721	300	TSA30080G	2,8	30	80	2,2	0°				5 090	hliník	118,37 €
B-09678	305	MSA30580G	2,3	30	80	1,8	-5°				5 000	hliník	99,41 €
B-09684	305	MSA305100G	2,3	30	100	1,8	-5°				5 000	hliník	107,15 €
B-09737	350	TSA350100G	3,2	30	100	2,6	0°				4 360	hliník	140,44 €
B-12522	355	TSA355120G	3	30	120	2,4	-5°				4 360	hliník	174,72 €



objednávacie číslo	popis	materiál	počet zubov	priemer (mm)	cena s DPH
D-62103	TCT kotúč 185 x 30 x 40T	hliník	40T	185	11,03 €
D-61874	TCT kotúč 260 x 30 x 100T	hliník	100T	260	33,49 €
D-61880	TCT kotúč 260 x 30 x 120T	hliník	120T	260	35,90 €

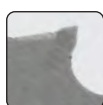

**PERFEKTNÝ PROFIL**

Zuby so špeciálnym profilom pre farebné kovy.



**MÁLO TRIESOK**

Pri použití na laminátové podlahové materiály vytvára málo triesok a odštiepkov.



# Pílové kotúče

## špeciálne kotúče na rezanie kovov pre kotúčové a skracovacie píly



Rada pílových kotúčov Makita na rezanie ocele konštruovaných tak, aby bol rez čistejší a rýchlejší. Predovšetkým vďaka zloženiu karbidu a špeciálnej konštrukcii hrotov sú tieto kotúče odolné proti nárazom a majú dlhú životnosť pri rezaní mäkkej oceli, plechu, potrubia, profilov alebo závitových tyčí.

Kotúče Makita zaisťujú rýchlejší a čistejší rez, pričom vydržia až 30 krát dlhšie ako klasické rezné kotúče. Presne nabrúsené hroty so špeciálnym zložením karbidu pre rýchle a čisté rezy. Malá iskrivosť a minimálna tvorba prachu. Menšie náklady na rez.

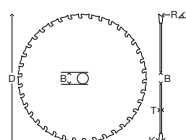

objednávacie číslo	ø kotúča (mm)	ID kód	hrúbka zuby (mm)	vrtanie (mm)	počet zubov	hrúbka kotúča (mm)	uhol zuby	ø krúžku (mm)	rez		max. otáčky (min <sup>-1</sup> )	materiál	cena s DPH
									priečny	pozdĺžny			
B-09743	185	MCS18536G	1,9	30	36	1,5	0°				5 800	mäkká oceľ	68,09 €
B-09759	185	MCS18538G	2	30	38	1,6	0°				5 800	mäkká oceľ	71,44 €
B-09787	185	MCS18548G	2	30	48	1,6	0°				5 800	mäkká oceľ	76,61 €
B-09771	185	MCS18570G	1,7	30	70	1,3	-10°				5 800	plech	81,24 €
B-09765	305	MCS30560F	2,1	25,4	60	1,7	0°				2 000	mäkká oceľ	143,21 €
B-09793	305	MCS30578F	2,3	25,4	78	2	-5°				2 000	tenká mäkká oceľ	213,32 €

## Špeciálne kotúče pre ponorné píly



Kotúče konštruované špeciálne pre ponorné píly sú určené na rezanie dreva a hliníku. Majú zvláštnu konštrukciu zaisťujúcu hladký a čistý rez. Kotúče pre ponorné píly majú podobnú špecifikáciu ako Premium MakBlade Plus s patentovanou technológiou eliminujúcou vibrácie. Práca s kotúčmi s nízkymi vibráciami je presnejšia pri menšom hádzaní a ľahko sa ponorí do materiálu pri vynaložení malého úsilia. Špeciálna antivibračná konštrukcia. Presne vystužené kotúče s plochejšími britmi pre perfektné rovné rezy. K dispozícii kotúče na rezanie dreva a hliníku.

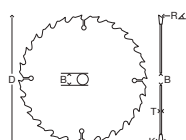

objednávacie číslo	ø kotúča (mm)	ID kód	hrúbka zuby (mm)	vrtanie (mm)	počet zubov	hrúbka kotúča (mm)	uhol zuby	ø krúžku (mm)	rez		max. otáčky (min <sup>-1</sup> )	materiál	cena s DPH
									priečny	pozdĺžny			
B-09260	160	CSP16028E	2,2	20	28	1,6	23°		•	•	9 540	drevo	44,55 €
B-09276	160	CSP16048E	2,2	20	48	1,6	8°		•	•	9 540	drevo	54,42 €
B-09282	165	CSP16528E	2,2	20	28	1,6	23°		•	•	9 250	drevo	46,05 €
B-09298	165	CSP16548E	2,2	20	48	1,6	8°		•	•	9 250	drevo	56,22 €
B-09307	165	CSPX16556E	2,4	20	56	1,7	-3°		•	•	9 250	hliník	79,00 €
B-10344	165	CSPX16548E	2,4	20	48	1,7					9 250	corrian	76,32 €
B-09313	185	CSP18524C	2,2	15,88	24	1,6	20°		•	•	8 250	drevo	23,87 €



# Pílové kotúče

## Špeciálne kotúče na rezanie sendvičových panelov pre kotúčové píly



Pílové kotúče vyrobené špeciálne pre rezanie sendvičových panelov. Extrémne pevné a odolné proti opotrebeniu, dlhá životnosť a produktivita.

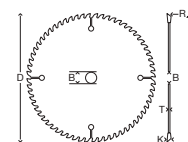

objednávacie číslo	ø kotúča (mm)	ID kód	hrúbka zuby (mm)	vrtanie (mm)	počet zubov	hrúbka kotúča (mm)	uhol zuby	ø krúžku (mm)	rez		max. otáčky (min <sup>-1</sup> )	materiál	cena s DPH
									priečný	pozdižny			
B-17675	235	CSF23550GL	2,1	30	50						6 500	s. panel	94,54 €
B-17681	270	CSF27060GL	2,2	30	60						5 650	s. panel	143,33 €
B-17697	355	CSF35580GL	2,9	30	80						4 300	s. panel	176,08 €
B-63133	165	CSF16542EL	1,4	20	42	1,75	0°				9250	s. panel	67,71 €

## Špeciálne pílové kotúče konštrukt pre kotúčové píly

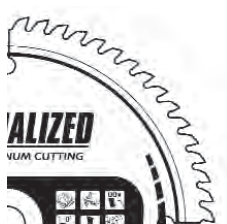

Špeciálna konštrukcia zubov týchto pílových kotúčov umožňuje rezať stavebné drevo s kľincami. Extrémne pevné a odolné proti opotrebeniu, dlhá životnosť a produktivita.

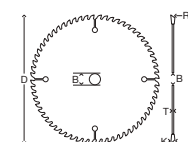

objednávacie číslo	ø kotúča (mm)	ID kód	hrúbka zuby (mm)	vrtanie (mm)	počet zubov	hrúbka kotúča (mm)	uhol zuby	ø krúžku (mm)	rez		max. otáčky (min <sup>-1</sup> )	materiál	cena s DPH
									priečný	pozdižny			
B-13683	190	CSCE19012G	2,6	30	12	1,6			•	•	8 400	drevo	29,22 €
B-13699	235	CSCE23516G	2,6	30	16	1,8			•	•	6 500	drevo	32,51 €

## Špeciálne pílové kotúče na kov a nehrdzavejúcu oceľ

objednávacie číslo	ø kotúča (mm)	ID kód	hrúbka zuby (mm)	vrtanie (mm)	počet zubov	hrúbka kotúča (mm)	uhol zuby	ø krúžku (mm)	rez		max. otáčky (min <sup>-1</sup> )	materiál	cena s DPH
									priečný	pozdižny			
B-23086	136	MCS13656E	1,5	20	56	1,5	-5				3 600	nerez	65,83 €
B-31669	185	MCSF18564GL	1,6	30	64	1,3	0				5 800	nerez	105,65 €
B-23123	305	MCS305100F	2,4	25,4	100	1,5	-5				2 000	nerez	321,28 €

## Redukčné krúžky pre pílové kotúče



objednávacie číslo	ø kotúča (mm)	cena s DPH
B-20987	20 mm × 15,88 mm × 1,2 mm	2,52 €
B-20993	20 mm × 15,88 mm × 1,8 mm	2,64 €
B-21004	30 mm × 15,88 mm × 1,2 mm	2,69 €
B-21010	30 mm × 15,88 mm × 1,8 mm	2,53 €
B-21026	30 mm × 20 mm × 1,2 mm	3,12 €
B-21032	30 mm × 20 mm × 1,4 mm	2,71 €
B-21048	30 mm × 20 mm × 1,8 mm	2,72 €
B-21054	30 mm × 25 mm × 1,6 mm	2,70 €
B-21060	30 mm × 25,4 mm × 1,4 mm	2,86 €
B-21076	30 mm × 25,4 mm × 2,2 mm	2,68 €

# Kotúčové a ponorné píly

obj. číslo	názov	5604R	5603R	HS6101	5017PKB	5704R	5705R/RK	HS7101/K	5903R	5103R	5143R	N5900B	5104S	SP6000/K	cena s DPH
164095-8		•		•		•		•							1,63 €
165108-8			•		•		•								5,07 €
165084-6	paralelný doraz								•	•			•		3,99 €
152498-8											•				56,10 €
164367-1												•			2,31 €
165447-6														•	13,51 €
192420-3			•				•	•							
456914-5	odsávací adaptér								•	•					2,31 €
415816-4											•				5,14 €
193068-4															6,92 €
450316-7															8,16 €
453289-3					•				•						
183288-8	lapač prachu				•										26,20 €
783203-8	montážny kľúč	•	•		•	•	•							•	0,76 €
783204-6				•				•	•	•	•		•		0,69 €
782016-4													•		0,59 €
824555-9	systainer	•	•			•									38,43 €
824554-1							•								37,80 €
193196-5									•						54,94 €
821552-6	systainer												•	51,69 €	
192505-5	adaptér pre vodiacu lištu	•		•		•									33,81 €
192506-3									•						156,53 €
192507-1											•				101,94 €
193517-1					•				•						23,35 €
199140-0	vodiaca lišta 1000 mm	•	•	•		•	•	•	•	•			•	32,18 €	
199141-8	vodiaca lišta 1500 mm	•	•	•		•	•	•	•	•			•	42,40 €	
194367-7	vodiaca lišta 3000 mm	•	•	•		•	•	•	•	•			•	174,99 €	



## Kotúčové a ponorné píly

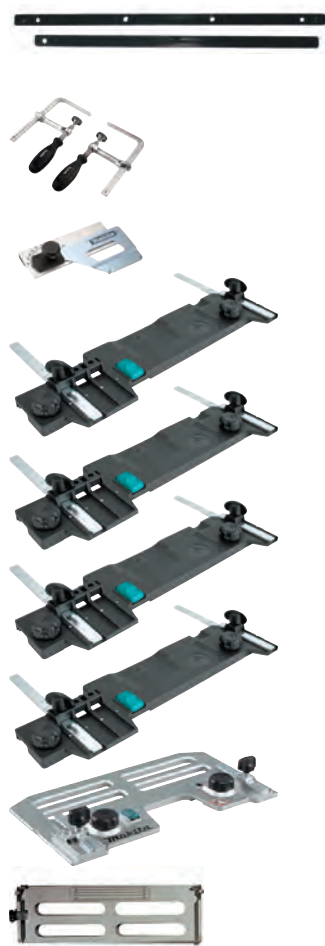

obj. číslo	popis	cena s DPH
P-20177	spojka vodiacej lišty	48,87 €
194385-5	skrutková svorka / pár	33,83 €
196664-7	uhlový adaptér k vodiacej lište SP6000/K	42,77 €
197252-3	adaptér na vodiacu lištu DHS630, DHS630, DHS710, HS7101, HS6101, 4350CT/FCT, 4351CT/FCT, DJV140, DJV, DJV180, DJV180, DJV181, DJV182	68,23 €
196953-0	adaptér na vodiacu lištu DHS680	52,81 €
197462-2	adaptér na vodiacu lištu HS6601	37,97 €
197005-0	adaptér na vodiacu lištu HS7601	55,08 €
198570-2	adaptér na vodiacu lištu HS0600	202,00 €
192506-3	adaptér na vodiacu lištu 5903R,5703R, 5705R, 5017RKB	156,53 €

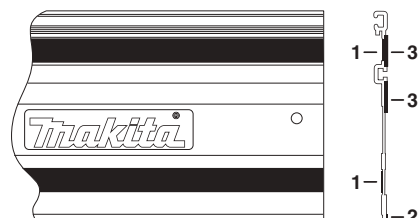

obj. číslo	popis	cena s DPH
423359-2	náhradná guma (2) ku lište 1400 mm	2,80 €
423386-9	náhradná guma (2) ku lište 1900 mm	4,33 €
423360-7	náhradná guma (2) ku lište 3000 mm	7,01 €
423361-5	náhradná penová hmota (3) ku lište 1400 mm	6,86 €
451330-6	náhradná penová hmota (3) ku lište 1900 mm	5,14 €
423362-3	náhradná penová hmota (3) ku lište 3000 mm	13,93 €
413101-9	náhradná klzná páska (1) k lište 1400 mm	3,88 €
423390-8	náhradná klzná páska (1) k lište 1900 mm	8,07 €
413102-7	náhradná klzná páska (1) k lište 3000 mm	6,72 €

# Príslušenstvo k aku pílam

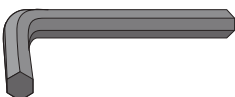





obj. číslo	popis	BSS500RFE	DHS630RFE	BSS610RFE	BCS550RFE	HS300DWE	cena s DPH
164095-8	paralelný doraz	•	•	•	•	•	1,63 €
231007-7	pružina dorazu						0,10 €
251896-4	skrutka dorazu						0,75 €
194415-2		•					2,37 €
452237-9	odsávací adaptér					•	0,72 €
194314-8			•				6,88 €
419283-5					•		1,71 €
783203-8	montážny kľúč	•	•	•	•	•	0,76 €
824802-8		•			•		18,05 €
824995-1	prepravny kufrik		•				61,14 €
824757-7					•		20,59 €
824961-8						•	21,00 €



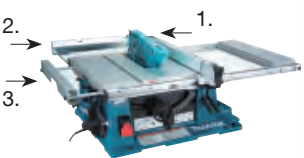

# Stolné a pokosové píly

	objednávacie číslo	popis	MLS100	MLT100	LS0714	LS1040	LH1040	2704	LS1013	LS1016L	LS1018L	LF1000	LS1214	LS1216L	LS1440	LS1019L	LS1219L	cena s DPH
	122852-0		•	•	•	•			•	•		•	•	•		•	•	3,36 €
	122330-0	vak na prach													•			15,41 €
	JM23100501										•							3,32 €
	410602-8	uzáver vaku na prach	•	•	•	•	•	•	•	•	•	•	•	•	•			0,33 €
	122571-8				•								•					8,96 €
	122728-1											•						14,74 €
	122536-0					•	•											8,16 €
	122538-6	zvislá svorka							•									10,03 €
	122854-6									•				•				19,96 €
	JM23100502										•							6,43 €
	JM23000131		•															4,90 €
	122563-7	vodorovná svorka			•	•	•									•		96,68 €
	122930-6														•			90,45 €
	123101-8				•	•	•											11,69 €
	JM23100500	predĺženie stola									•							7,49 €
	JM23000127		•															8,43 €
	762001-3	nastavovací trojuholník	•	•	•	•			•	•	•	•	•	•	•	•	•	0,56 €
	153896-9	prídavný doraz vpravo							•				•					32,26 €
	782223-9	montážny kľúč nástrč. kľúč 13			•													1,42 €
	783208-8	montážny kľúč			•					•				•	•	•		0,54 €
	122729-9	vodiaci doraz										•						30,60 €
	122707-9						•											11,34 €
	122732-0	1. sada na odsávanie										•						23,49 €
	122730-4	2. uhlový doraz 3. kryt komplet										•						18,74 €
	126617-2	zvislá svorka														•	•	20,97 €
	326978-2															•		4,31 €
	327145-2	predĺženie stola															•	3,36 €
	327095-1																•	4,82 €
	123980-4	sada odsávania														•		46,41 €
	126792-4																•	53,37 €

# Stolné a pokosové píly

objednávacie číslo	popis	MLS100	MLT100	LS0714	LS1040	LH1040	2704	LS1013	LS1016L	LS1018L	LF1000	LS1214	LS1216L	LS1440	cena s DPH
 194241-9	klzné vedenie						•								165,65 €
 122734-6	uhlový doraz						•								43,16 €
122740-1	1. vodiaci doraz						•								110,39 €
 194087-3	2. predĺženie stola vzadu						•								44,43 €
194086-5	3. predĺženie stola vľavo						•								43,31 €
 JM21080290	tyč pre posun materiálu		•			•	•								1,15 €
 193730-1	žiarovka pre všetky pokosové píly s označením f														4,27 €

# Stolné a pokosové píly

objednávacie číslo	popis	MLS100	MLT100	LS0714	LS1040	LH1040	2704	LS1013	LS1016L	LS1018L	LF1000	LS1214	LS1216L	LS1440	LS1019	LS1219	cena s DPH
194043-3				•	•	•		•	•	•		•	•	•			122,58 €
194093-8	 pracovné stoly						•										400,30 €
DEAWST05		•		•	•	•		•	•	•		•	•	•	•	•	295,93 €
JM27000300			•														275,03 €

## Univerzálny stôl pre pokosové píly: 1170/2700 x 500 x 550/800 mm



objednávacie číslo	pre modely	cena s DPH
DEAWST06	LS0714, LS0815, LS1013, LS1016, LS1017, LS1018, LS 1019, LS1040, LS1212, LS1214, LS1216, LS1219, LS1220, BLS713, MT230, MLS100	233,44 €

# PRÍSLUŠENSTVO

## ▣ Priamočiare a chvostové píly



TC plátky



diamantové zrno



zrnitosť



priame rezy



rezanie oblúkov



jemný rez



hrubý rez



tvrdý materiál



tenký materiál



tvrdé zuby



počet zubov na palec



nepoužívať na predrez



použitie chladiacej zmesi



# Príslušenstvo

## Typ zubu

frézované bočné zuby

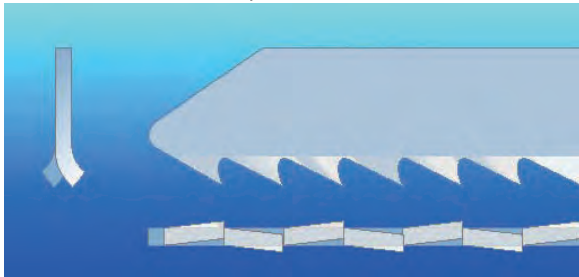

pozdĺžne a bočné zuby



frézované vlnité zuby



tvrdé kuželovité zuby

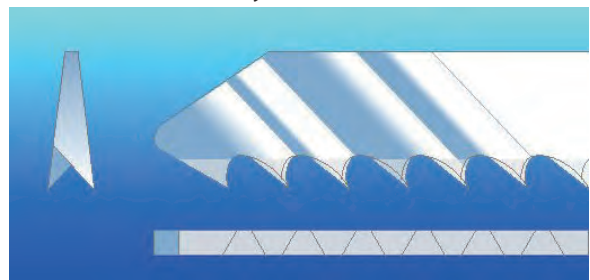

### frézované zuby

- pre bežné rezanie
- mäkké až tvrdé materiály
- dlhá životnosť



### tvrdé zuby

- veľmi ostré zuby
- presný a čistý rez
- mäkké až stredne tvrdé materiály



## Production method

- **bočné zuby:** každý jednotlivý zub je striedavo ohnutý dolava a doprava. Príklad: pravá, ľavá, rovná atď.
- **vlnité zuby:** zuby sú tvarované do vlnovky
- **tvrdé zuby:** teleso čepele sa zužuje smerom dozadu (kuželovité)



bočné zuby

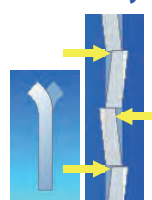

vlnité zuby



tvrdé zuby

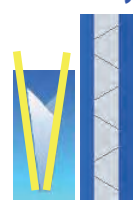

## použitie materiálov na výrobu pílových listov

- **HCS (ocel s vysokým obsahom uhlíka)** na rezanie mäkkých materiálov, ako je drevo alebo plasty.
- **HSS (rýchlorezná ocel)** na rezanie tvrdších materiálov, ako sú kovy.
- **BiM (dvojkov /HCS a HSS/)** na rezanie mäkkých materiálov a tvrdých materiálov ako drevo, kovy, plasty.
- **TC (karbid volfrámu)** na rezanie plastov vystužených sklenenými vláknami, cementovo viazaných drevovláknitých dosiek alebo sadrokartónu.

# Príslušenstvo

## Japonské zuby Reciprosaw Blade



### vlastnosti

#### 1. japonské zuby s ostrou hranou

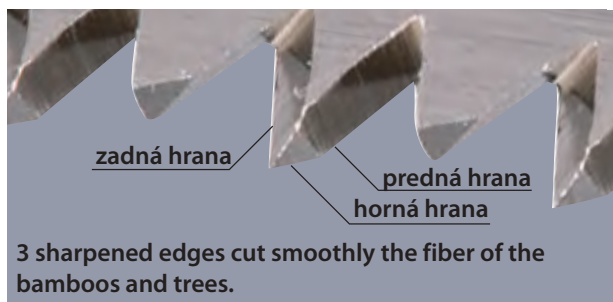

#### 2. čistý dorez materiálu

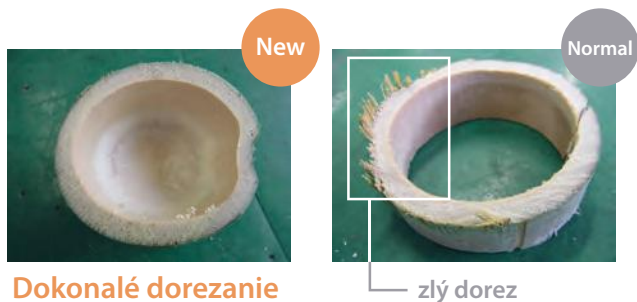

### Použitie

#### dutý materiál

15TPI

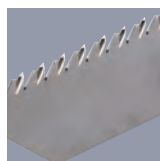

#### mokrú drevo



8.5TPI



## TC Reciprosaw Blade

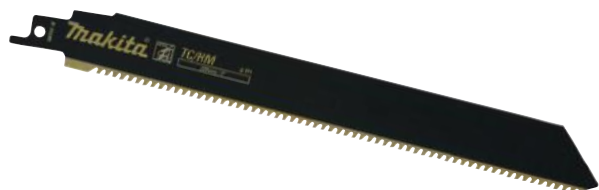

### vlastnosti

karbid volfrámu



### Použitie

#### pre liatinu



#### pre nehrdzavejúcu oceľ





# Pílové listy

## Do priamočiarych píl s univerzálnou stopkou

Hustota píleného materiálu je veľmi odlišná. Najmä pri pílení sa preto vyžaduje dokonalá geometria zubov a pílového listu, aby sa dosiahla optimálna kvalita rezu. Pílové listy sú presne koncipované na požiadavky príslušného materiálu a tak umožňujú dosiahnuť perfektný výsledok pílenia. Pri vyššom namáhaní pri pílení kovov sa musí používať zodpovedajúce chladiace médium na predĺženie životnosti pílového listu.

### Materialy, používané pri výrobe pílových listov do priamočiarych píl

HSS (High Speed Steel – rýchlorezná ocel) na kovy, hliník, neželezné kovy  
 HCS (High Carbon Steel – uhlíková ocel) na drevo, plasty  
 CV (legovaná nástrojová ocel) na drevo, plasty  
 HM (Hartmetall – tvrdý kov) na ušľachtilú ocel, neželezné kovy, pórobetón  
 BiM (Bi-Metal – dvojkov) na hliník, kovy, neželezné kovy



Chladiace médium: ◆ rezací olej Chladiace médium: • terpentín Chladiace médium: ■ voda

obj. číslo	materiál	dĺžka* (mm)	TPI**	popis	na kovy	na drevo	rôzne materiály	ks/bal.	cena s DPH
 B-07674	uhlíková ocel	80	9	B10 bez vylamovania rezných hrán. Veľmi rýchly a čistý rez.		tvrdé a mäkké drevo, preglejky		100	106,70 €
 B-07680	uhlíková ocel	75	9	B11 veľmi čistý rez		tvrdé a mäkké drevo, preglejky a drevovláknité dosky do 30 mm	Plasty ■	100	111,87 €
 B-07696	uhlíková ocel	80	6	B12 veľmi čistý rez		tvrdé a mäkké drevo, preglejky a drevovláknité dosky do 60 mm	Plasty ■	100	97,93 €
 B-07705	uhlíková ocel	80	8	B13 hrubý rez		tvrdé a mäkké drevo do 60 mm	Plasty ■	100	70,85 €
 B-07733	rýchlorezná ocel	50	14	B23	mäkká ocel ◆ 3–6 mm, farebné kovy, zliatiny hliníka 3–10 mm • ◆			100	84,75 €
 B-07749	rýchlorezná ocel	50	24	B22	mäkká ocel ◆ farebné kovy • ◆ hliník a jeho zliatiny • ◆ plechy z nehrdzavejúcej ocele 1,5–4 mm			100	87,97 €

\*\* počet zubov na palec (teeth per inch)



# Pílové listy

Do priamočiarych píl s univerzálnou stopkou

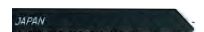

obj. číslo	materiál	dĺžka* (mm)	TPI**	popis	na kovy	na drevo	rôzne materiály	ks/bal.	cena s DPH
B-07711	uhlíková ocel	75	6	B16 rýchly rez		tvrdé a mäkké drevo, preglejky a drevovláknité dosky do 30 mm	plasty ■	100	87,69 €
B-07777	uhlíková ocel	65	9	BR13 veľmi čistý rez		tvrdé a mäkké drevo, preglejky a drevovláknité dosky, dosky s vrstvami z plastov do 60 mm		100	73,07 €
B-07755	rýchlorezná ocel	75	9	B25	mäkká ocel ◆ 3–6 mm, farebné kovy, zliatiny hliníka • ◆ 3–15 mm olovo a zinok ◆ do 20 mm		plasty do 30 mm, vystužené plasty do 20 mm	100	100,89 €
B-07727	uhlíková ocel	45	14	B18 pílový list na pílenie v krivkách, veľmi úzky	na pílenie do dreva do 20 mm v úzkych krivkách alebo pravých uhloch		na pílenie do plastov do 20 mm v úzkych krivkách alebo pravých uhloch	100	64,25 €
B-07761	uhlíková ocel	45	16	B29 pílový list na pílenie v krivkách	tvrdé drevo, mäkké drevo, preglejky a drevovláknité dosky 2–25 mm		plasty lamináty 2–25 mm	100	116,92 €
A-86290	uhlíková ocel	105	7	L1 veľmi tenký pílový list na rovné rezy, so šikmým ostrením a kónickým výbrusom, delenie zubov 4 mm		tvrdé a mäkké drevo, preglejky, drevovláknité dosky do 80 mm	plasty do 80 mm	5	9,50 €
A-86309	uhlíková ocel	105	7	L2 rýchly rez, s rozvedenými a ostrenými zubami (šikmé), delenie zubov 4 mm		tvrdé a mäkké drevo do 80 mm		5	7,98 €
A-86315	uhlíková ocel	155	7	L10 s rozvedenými a ostrenými zubami, delenie zubov 4 mm		tvrdé a mäkké drevo do 110 mm		5	9,34 €

\*\* počet zubov na palec (teeth per inch)



# Pílové listy

Do priamočiarych píl s univerzálnou stopkou

	obj. číslo	materiál	dĺžka* (mm)	TPI**	popis	na kovy	na drevo	rôzne materiály	ks/bal.	cena s DPH
	P-05929	tvrdý kov	50	24	pílový list z tvrdého kovu	ušľachtilá oceľ ♦ 5 mm neželezné kovy • ♦ 10 mm			1	10,72 €
	A-85737	rýchlorezná oceľ	50	24	B22	mäkká oceľ ♦ farebné kovy • ♦ hliník a jeho zliatiny • ♦ plechy z nehrdzavejúcej ocele 1,5–4 mm			5	4,84 €
	A-85709	rýchlorezná oceľ	42	16	B29 pílový list na pílenie v krivkách, veľmi úzky		tvrdé drevo, mäkké drevo, drevotrieskové dosky 2–25 mm	plasty-lamináty 2–25 mm	5	3,80 €
	A-85743	rýchlorezná oceľ	50	14	B23	mäkká oceľ ♦ 3–6 mm, farebné kovy, zliatiny hliníka 3–10 mm • ♦			5	4,84 €
	A-85759	rýchlorezná oceľ	50	32	B24 pri pílení plechov pod 1 mm píliť spolu s drevenou podložkou.	mäkká oceľ ♦ farebné kovy • ♦ zliatiny hliníka do 2 mm			5	5,07 €
	A-85765	rýchlorezná oceľ	75	9	B25	mäkká oceľ ♦ 3–6 mm, farebné kovy, zliatiny hliníka • ♦ 3–15 mm olovo a zinok ♦ do 20 mm		plasty do 30 mm, vystužené plasty do 20 mm	5	5,91 €
	A-85771	rýchlorezná oceľ	75	9	B26 vhodný najmä na pílenie v krivkách	mäkká oceľ ♦ 3–6 mm farebné kovy, zliatiny hliníka • ♦ 3–15 mm olovo a zinok ♦ do 20 mm		plasty do 30 mm, vystužené plasty do 20 mm	5	6,95 €
	A-85721	rýchlorezná oceľ	75	12	B21 veľmi čistý rez	farebné kovy • ♦ hliník • ♦ do 10 mm			5	8,87 €

\*\* počet zubov na palec (teeth per inch)



# Pílové listy

Do priamočiarych píl s univerzálnou stopkou

	obj. číslo	materiál	dĺžka* (mm)	TPI**	popis	na kovy	na drevo	rôzne materiály	ks/bal.	cena s DPH
	A-85787	rýchlorezná ocel	75	24	B27 vhodný najmä na pílenie v krivkách	mäkká oceľ 4 3 mm, farebné kovy • ♦ zliatiny hliníka • ♦ do 6 mm	tvrdé a mäkké drevo do 8 mm	lisované materiály, tvrdá tkanina, izolačné materiály do 8 mm	5	5,49 €
	A-85662	uhlíková ocel	50	18	B14		preglejký a drevovláknité dosky do 15 mm	lisované materiály, tvrdá tkanina, izolačné materiály do 8 mm, plexisklo a linoleum ■ do 8 mm	5	3,69 €
	A-85678	uhlíková ocel	50	12	B15		preglejký a drevovláknité dosky do 30 mm	lisované materiály, tvrdá tkanina, izolačné materiály do 20 mm, plexisklo ■ do 20 mm	5	3,72 €
	A-85709	uhlíková ocel	45	14	B18 pílový list na pílenie v krivkách, veľmi úzky		na pílenie do dreva do 20 mm v úzkych krivkách alebo pravých uhloch	na pílenie do plastov do 20 mm v úzkych krivkách alebo pravých uhloch	5	3,80 €
	A-85634	uhlíková ocel	75	9	B11 veľmi čistý rez		tvrdé a mäkké drevo, preglejký a drevovláknité dosky do 30 mm	plasty ■	5	5,80 €
	A-85640	uhlíková ocel	80	6	B12 veľmi čistý rez		tvrdé a mäkké drevo, preglejký a drevovláknité dosky do 60 mm	plasty ■	5	5,83 €
	A-85656	uhlíková ocel	80	8	B13 hrubý rez		tvrdé a mäkké drevo do 60 mm	plasty ■	5	3,92 €
	A-85793	uhlíková ocel	65	9	BR13 veľmi čistý rez		tvrdé a mäkké drevo, preglejký a drevovláknité dosky, dosky s vrstvami z plastov do 60 mm		5	4,33 €

\*\* počet zubov na palec (teeth per inch)





# Pílové listy

Do priamočiarych píl s univerzálnou stopkou

	obj. číslo	materiál	dĺžka* (mm)	TPI**	popis	na kovy	na drevo	rôzne materiály	ks/bal.	cena s DPH
	A-85232	uhlíková ocel	75	8	B8		2° efekt výkyvu, pre modely bez výkyvu pílového listu; na mäkké a tvrdé drevo 4-60 mm	2° efekt výkyvu, pre modely bez výkyvu pílového listu; na plasty 4-60 mm	5	5,54 €
	A-85690	uhlíková ocel	70	6	B17 vhodný najmä na rezy v krivkách		tvrdé a mäkké drevo do 60 mm		5	5,25 €
	A-85715	uhlíková ocel	70	9	B19 bez vylamovania rezných hrán		tvrdé a mäkké drevo, preglejky		5	5,71 €
	A-85628	uhlíková ocel	80	9	B10 bez vylamovania rezných hrán; veľmi rýchly a čistý rez.		tvrdé a mäkké drevo, preglejky		5	5,82 €
	B-06890	tvrdý kov	75	17	B60		lisované drevotrieskové dosky 5-50 mm	stavebný materiál 5-50 mm	3	20,93 €
	B-06909	tvrdý kov	105	24	B61		lisované drevotrieskové dosky 5-50 mm	stavebný materiál 5-50 mm	3	30,10 €
	B-10970		59	13	veľmi čistý rez		laminát, laminátové podlahy		5	11,22 €
	B-10986		59	13	veľmi čistý rez		laminát, laminátové podlahy		5	13,03 €

\*\* počet zubov na palec (teeth per inch)





# Pílové listy

Do priamočiarych píl s univerzálnou stopkou







	obj. číslo	materiál	dĺžka* (mm)	TPI**	popis	na kovy	na drevo	rôzne materiály	ks/ bal.	cena s DPH
	P-31566		60	13	veľmi čistý rez		laminát, laminátové podlahy		5	9,30 €
	P-31572		75	6,35	rýchly rez		všetky typy dreva		5	6,11 €
	P-38788		54		hrubý rez			sklo, keramika, fibrové sklo	3	12,94 €
	P-05929		75		rýchly rez	železo 1–5 mm hliník, zinok 1,5–3 mm nerez 1–2,5 mm			1	10,72 €
	P-49622		100		rýchly rez	na železo	drevo s klincami		5	8,86 €
	P-49644		180		rýchly rez	železo, hliník.		sendvičové panely.	5	11,06 €
	P-71308-25		116		rýchly rez		všetky typy dreva		25	27,73 €
	P-47204		130	25	rýchly rez		sendvičové panely	5	9,20 €	

\*\* počet zubov na palec (teeth per inch)







# Pílové listy



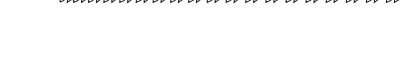

Do priamočiarych píl Super Express s univerzálnou stopkou

obj. číslo	dĺžka* (mm)	TPI**	popis	materiál	ks/bal.	cena s DPH
 B-06460	77	8,5–10,6	B50 pílový list z uhlíkovej ocele	preglejký 5–50 mm, plasty 5–50 mm	5	5,86 €
 B-06476	77	9,8–18,1	B51 pílový list z rýchloreznej ocele	mäkká oceľ 1–8 mm, nehrdzavejúca oceľ 1-3 mm	5	6,51 €
 B-06482	77	5,5–9,8	B52 pílový list z rýchloreznej ocele	drevo 5–50 mm, plasty 5–50 mm, hliník 3–35 mm, nehrdzavejúca oceľ 3–5 mm, mäkká oceľ 3–8 mm	5	6,84 €
   B-06292			sada, obsahujúca 1 × B-06460 1 × B-06476 1 × B-06482	pozri materiály pílových listov B-06460 B-06476 B-06482	3	4,34 €

## Pílové listy do chvostových píl „Super Express“

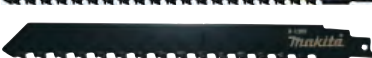
obj. číslo	dĺžka* (mm)	TPI**	popis	materiál	ks/bal.	cena s DPH
 B-05038	152	7,5	Pílový list z dvojkovu	plechy 1–8 mm, profily 5–100 mm	5	14,58 €
 B-05038-25	152	7,5	Pílový list z dvojkovu	plechy 1–8 mm, profily 5–100 mm	25	62,38 €
 B-05044	152	5,5	Pílový list z dvojkovu	drevo s kĺncami, hliníkové profily 3–18 mm, plasty, sklolaminátové dosky	5	14,36 €
 B-05044-25	152	5,5	Pílový list z dvojkovu	drevo s kĺncami, hliníkové profily 3–18 mm, plasty, sklolaminátové dosky	25	61,40 €
 B-05153	203	10,6	Pílový list z uhlíkovej ocele	plasty 6–150 mm, drevo, panely do 175 mm, stavebné rezivo 6–150 mm, drevotrieskové dosky, preglejky	5	15,27 €
 B-05153-25	203	10,6	Pílový list z uhlíkovej ocele	plasty 6–150 mm, drevo, panely do 175 mm, stavebné rezivo 6–150 mm, drevotrieskové dosky, preglejky	25	66,86 €

## Pílový list na tehly a porobetón

obj. číslo	dĺžka* (mm)	TPI**	hrúbka (mm)	výška plátku (mm)	materiál	ks/bal.	cena s DPH
 B-10394	300	12,7/2	1,5		tehla, porobetón	1	34,10 €
 B-10403	450	12,7/2	1,5		tehla, porobetón	1	47,63 €
 B-12809	240	12,7/2	1,5		tehla, porobetón	1	25,02 €
 B-63585	305	8,5/3	1,5	2,2	Ytong, porobetón, sadru, pálené tehly	2	37,54 €
 B-63591	400	12,7/2	1,5	2,2	Ytong, porobetón, sadru, pálené tehly	2	49,61 €

\* uvedená dĺžka je ozubená dĺžka



# Pílové listy

Pílové listy do chvostových píľ s univerzálnou stopkou

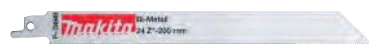









objednávacie číslo	dĺžka* (mm)	TPI**	popis	materiál	ks/bal.	cena s DPH
P-04874	100	18	pílový list z dvojkovu	plechy a profily 1,5–3mm	5	10,94 €
P-04880	150	18	pílový list z dvojkovu	plechy a profily 1,5–3mm	5	11,51 €
P-04896	100	24	pílový list z dvojkovu	plechy a profily 1,2–2mm	5	10,96 €
P-04905	150	24	pílový list z dvojkovu	plechy a profily 1,2–2mm	5	11,58 €
P-04911	150	14	pílový list z dvojkovu	ocel a farebné kovy 3–8mm	5	11,53 €
P-04927	200	14	pílový list z dvojkovu	ocel a farebné kovy 3–8mm	5	15,62 €
P-04933	200	18	pílový list z dvojkovu	ocel a farebné kovy 1,5–3mm	5	15,48 €
P-04949	200	24	pílový list z dvojkovu	ocel a farebné kovy 1,2–2mm	5	15,55 €
P-04955	150	32	pílový list z dvojkovu	ocel, farebné kovy a profily do 1mm	5	12,69 €
P-04961	75	18	pílový list z dvojkovu	hliník, polyester, plasty, oceľové plechy 1,5–3mm	5	13,28 €
P-04983	290	10	pílový list z dvojkovu	liatinové a oceľové rúry 3–10mm, farebné kovy, izolačný materiál a drevo s klincami	5	19,22 €
P-05088	150	6	pílový list z dvojkovu	liatinové a oceľové rúry 3–12mm, farebné kovy, izolačný materiál a drevo s klincami	5	17,90 €
P-04999	150	4	pílový list z rýchloreznej ocele	všetky druhy dreva (najmä na mokré drevo), sádra, hrubý rez, od 3mm	5	8,33 €
P-05000	150	10	pílový list z rýchloreznej ocele	všetky druhy dreva, drevené palety a sádra, jemný rez, do 3mm	5	8,21 €
B-55566	100	8	pílový list z rýchloreznej ocele	železo, nerez, liatinové rúry	1	11,98 €
B-55572	152	8	pílový list z rýchloreznej ocele	železo, nerez, liatinové rúry	1	15,80 €
B-55588	288	8	pílový list z rýchloreznej ocele	železo, nerez, liatinové rúry	1	19,32 €
B-55594	305	8	pílový list z rýchloreznej ocele	železo, nerez, liatinové rúry	1	24,21 €

\* uvedená dĺžka je ozubená dĺžka; \*\* počet zubov na palec (teeth per inch)



# Pílové listy

objednávacie číslo	popis	celková dĺžka (mm)	prac. dĺžka (mm)	ks/bal	TPI	poznámka	cena s DPH
 B-31887	Bi-metal pílový plátok na drevené a laminátové podlahy	100	77	5			11,33 €
 B-16841	Bi-metal pílový plátok na železo (10–100mm)	150	127	5	14		10,37 €
 B-20395	Bi-metal pílový plátok na železo (0,7–3mm)	100	75	5	24		10,03 €
 B-20426	Bi-metal pílový plátok na železo (3–12mm) a drevo s klincami (10–50mm)	100	75	5	10		10,03 €
 B-20410	Bi-metal pílový plátok na železo (3–8mm)	100	75	5	14		10,03 €
 B-16835	Bi-metal pílový plátok na železo (5–100mm)	150	127	5	24		10,37 €
 B-16813	HCS pílový plátok na drevo	150	127	5	3	rýchly rez	7,74 €
 B-31843	Bi-metal pílový plátok na palety, drevo/železo	150	127	5	10		10,38 €
 B-43175	Bi-metal pílový plátok na železo (3–8mm) (ø max175mm)	225		5	14+18		18,28 €



# Pílové listy



objednávacie číslo	popis	celková dĺžka (mm)	prac. dĺžka (mm)	ks/bal	TPI	poznámka	cena s DPH
B-16782	Bi-metal pílový plátok na železo (5–175mm)	225	205	5	18		15,64 €
B-12809	Pílový plátok na tehly (10–175 mm)	240	180	1	2		25,02 €
B-16807	HCS pílový plátok na drevo, OSB dosky/preglejka	150	127	5	10		7,74 €
B-31871	Diamantový pílový plátok na liatinové-železné rúry (Ø 150 mm)	223	205	2			39,92 €
B-16798	HCS pílový plátok na drevo, OSB dosky/preglejka	150	127	5	6	rýchly rez	7,74 €
B-16863	HSS pílový plátok na mokré drevo a opílovanie stromov	280	250	5	6,4		17,90 €



## Pílové listy do chvostových píl s univerzálnou stopkou pre rezanie izolačných materiálov (sklená vlna ,nobasil, polystyrén)



objednávacie číslo	popis	ks/bal	materiál	cena s DPH
P-80438	225x19x1,17	5	uhlíková oceľ	22,90 €
P-80444	300x19x1,27	1	uhlíková oceľ	31,45 €
B-52130	400x45x1,5	5	uhlíková oceľ	28,46 €

## Príslušenstvo pre DSD180/SD100



objednávacie číslo	popis	ks/bal	cena s DPH
B-49703	pílový plátok na sadrokartón	2	21,41 €
B-49719	pílový plátok na drevo	2	30,12 €



# Pílové listy

Pílové listy do chvostových píl s univerzálnou stopkou



objednávacie číslo	dĺžka* (mm)	TPI**	popis	materiál	ks/bal.	cena s DPH
P-45705	150		špeciálne zuby v tvare m	nerez, železo, hliník	5	15,53 €
P-45711	200		špeciálne zuby v tvare m	nerez, železo, hliník	5	18,78 €
P-46975	225	10	Bi-metal demolačný pílový list	železo, drevo s klinecami	3	13,97 €
P-47042	225	6	Bi-metal demolačný pílový list	železo, drevo s klinecami	3	14,16 €

## Pílové listy pre LB1200F



objednávacie číslo	šírka (mm)	TPI**	materiál	ks/bal.	cena s DPH
JM21080294	6	6	drevo, univerzálny rez	1	30,12 €
JM21080295	13	4	drevo, univerzálny rez	1	30,60 €
JM21080296	16	4	drevo, priečny rez	1	30,48 €
JM21080297	16	14	neželezný kov, hliník, mosadz, bronz, meď	1	24,61 €

Rozmery všetkých pílových pásov: 2240 x 0,5 mm



objednávacie číslo	názov	šírka	zuby/palec	použitie	ks/bal	cena s DPH
B-16689	pílový pás	6	6	drevo – rezanie do oblúku	3	55,40 €
B-16673	pílový pás	13	4	drevo – univerzál	3	53,64 €
B-16667	pílový pás	16	4	drevo – priečne rezy	3	63,44 €
B-16695	pílový pás	16	14	neželezné kovy	3	73,32 €
JM21080291	imbus kľúč 4				1	0,47 €
JM21080292	imbus kľúč 5				1	0,47 €
JM21080293	adaptér na odsávanie				1	0,89 €
JM21080290	tyč pre posun materiálu				1	1,15 €
JM21080260	mierka				1	10,67 €
JM21080230	paralelný doraz				1	22,05 €
JM23300008	paralelný doraz				1	43,25 €



# Pílové listy

Pílové listy do chvostových píl s univerzálnou stopkou

	objednávacie číslo	dĺžka* (mm)	TPI**	popis	materiál	ks/bal.	cena s DPH
	P-05022	150	6	pílový list z rýchlereznej ocele, hrubý a rýchly rez	všetky druhy dreva bez klincov, plasty, hrubý a rýchly rez, ako aj rezy v krivkách, od 3 mm	5	9,10 €
	P-05016	300	6	pílový list z rýchlereznej ocele, hrubý a rýchly rez	všetky druhy dreva bez klincov, plasty, hrubý a rýchly rez, ako aj rezy v krivkách, od 3 mm	5	13,24 €
	B-16829	300	6	pílový list z uhlíkovej ocele	s rozvedenými a šikmo brúsenými zubami, na všetky druhy dreva od 3 mm	5	12,84 €
	P-05038	90	6	pílový list so zubami z tvrdého kovu	drevotrieskové dosky, GFK, eternit, liatina, oceľoliatina, karbón, polyuretánová pena, abrazívne materiály od 3 mm	1	20,96 €
	P-05044	150	6	pílový list so zubami z tvrdého kovu	drevotrieskové dosky, GFK, eternit, liatina, oceľoliatina, karbón, polyuretánová pena, abrazívne materiály od 3 mm	1	22,61 €
	P-05050	300	6	pílový list so zubami z tvrdého kovu	GFK, eternitové rúry, abrazívne materiály, atď. od 3 mm	1	54,06 €
	P-05066	400	3		porobetón, plynobetón		46,58 €
	B-16863	300	4-5	pílový list z rýchlereznej ocele	s ozubením na rez čerstvého dreva, odvetvovanie a rez stromov, hrubý rez	5	17,90 €
	B-05169	152	18	pílový list z dvojkovu	tenké kovové dosky 1,5–4 mm, rúry, profily 5–100 mm	5	10,38 €
	B-05175	152	6	pílový list z dvojkovu	drevo s klincami 10–100 mm, plastové profily 5–100 mm, GFK, drevo, kovy, rámy okien do 100 mm	5	12,24 €
	B-10637	305	8	pílový list z dvojkovu	drevo s klincami, plastové profily, GFK, drevo, kovy, rámy okien	3	13,88 €
	B-07250	152	18	pílový list so zubami z tvrdého kovu na kovy	nehrdzavejúca tvarovaná oceľ 5–100 mm, dosky z nehrdzavejúcej ocele 2–4 mm	2	29,28 €
	B-10609	305	3	pílový list z nereze	mrazené potraviny, kosti	1	8,40 €

\* uvedená dĺžka je ozubená dĺžka





# Pílové listy

## Pílové listy do chvostovej píly JR1000FTK

	objednávacie číslo	dĺžka* (mm)	TPI**	popis	na kovy	na drevo	rôzne materiály	ks/bal.	cena s DPH
	A-85232	75	8	B8		2° efekt výkyvu, pre modely bez výkyvu pílového listu; na mäkké a tvrdé drevo 4–60 mm	2° efekt výkyvu, pre modely bez výkyvu pílového listu; na plasty 4–60 mm	5	5,54 €
	A-85628	80	9	B10 žiadne vylamovanie rezných hrán; veľmi rýchly a čistý rez		tvrdé a mäkké drevo, preglejky		5	5,82 €
	A-85715	70	12	B19 žiadne vylamovanie rezných hrán		tvrdé a mäkké drevo, preglejky		5	5,71 €
	A-85737	50	24	B22	mäkká oceľ F, farebné kovy I F, hliník a zliatiny hliníka I F 1,5-4 mm, plechy z nehrdzavejúcej ocele			5	4,84 €
	A-85759	50	32	B24 Pri pílení plechov pod 1 mm píliť spolu s drevenou podložkou.	mäkká oceľ F, farebné kovy I F, hliník a zliatiny hliníka I F 2 mm			5	5,07 €
	B-04961	50	24	B30	mäkká oceľ F, farebné kovy I F, hliník a zliatiny hliníka I F 1-3 mm		2° efekt výkyvu, pre modely bez výkyvu pílového listu; plasty n 1–6 mm	5	4,54 €
	A-80416	75	-	B-K			penový polystyrén do 50 mm, lepenka do 30 mm, guma do 10 mm, koža do 5 mm	5	18,06 €
	P-80438	255					polystyrén, sklená vata	3	23,19 €
	P-80444	300					polystyrén, sklená vata	3	31,87 €
	B-20448	100	6				sadrokartón 5–50 mm	5	11,35 €
	B-20454	100	14–18		železo	drevo	plast	5	11,35 €
	B-31859	225	10			drevo s klincami (palety)		5	15,80 €



# Pílové listy

Špeciálne príslušenstvo do chvostovej píly JR1000FTK

obj. číslo	popis	ks/ bal.	cena s DPH
B-04977	brúsny list/velkronové upínanie, zrnitosť 60 na drevo, rozmery 95 × 22 mm	10	4,22 €
A-40951	plochý pilník na kovy; celková dĺžka 153 mm; pracovná dĺžka 60 mm	3	26,31 €



## Pílové plátky s upínaním Makita



obj. číslo	typ	pracovná dĺžka (mm)	zub/palec	materiál	ks/ bal.	cena s DPH
A-85868	3 / HCS	60	9	drevo, plast	5	3,86 €
A-85818	10 / HCS	60	9	drevo, preglejka, rýchly rez	5	6,97 €
A-85846	17 / HSS	63	14	drevo, preglejka, obľý rez	5	5,78 €
A-02288	BR-3 / HCS	60	9	drevo, čistý rez	5	4,58 €
A-85802	1 / HCS	60	24	tenké železo	5	5,97 €
B-00022	HCS	120	6	všetky typy dreva	5	9,64 €
792543-3	HCS	120	9	všetky typy dreva	5	10,43 €



obj. číslo	popis	ks/ bal.	cena s DPH
A-86882	univerzálna sada pílových plátok s upínaním Makita	1	5,42 €

# Tabuľka na použitie pílových listov Makita

materiál	priamy rez		rez do oblúka		silný rez		tenký rez		čistý rez		rýchly rez	
	MAKITA	EKVIVALENT	MAKITA	EKVIVALENT	MAKITA	EKVIVALENT	MAKITA	EKVIVALENT	MAKITA	EKVIVALENT	MAKITA	EKVIVALENT
tvrdé drevo	B8		B17	T244D	L10		B11	T101B	BR13		L2	
	B11	T101B	B29	T101A0	B8		B15	T119B	B11	T101B	B13	T111C
	B12	T101D	B18	T119B0	B12	T101D			B19	T101BR	B16	T144D
		T101DP			B16	T144D			B29	T101A0		
drevovláknité dosky	B10		B17	T244D			B14		B13		B16	T144D
	B12	T101D		T101A0	B12	T101D	B15		B11	T101B		T11C
	B29	T141HM	B18	T119B0		T301CD	B11	T101B			B17	T244D
		T101DP				T101CD		T301CD				
MFC	B50	T234X			B50	T234X	B50	T234X			B50	T234X
	BR13		B29	T101A0	L2		B29	T101A0	B19	T101BR	B12	T101D
preglejka	B19	T101BR			B12	T101D			B29	T101A0		
						T101DP						
	B8		B29	T101A0	B8		B29	T101A0	B29	T101A0	B15	T119D
	B11	T101BR		T301CD	B15	T119B			B19	T101BR		
laminované drevo	B15	T119B			B11	T101B						
	B50	T234X			L2		B50				B50	T234X
					B50	T234X		T234X				T234X
	BR13		B29		L2		B11	T101B	BR13		B16	T144D
drevo s klinecami	B12	T101D	B17	T244D	B29	T101A0			B11	T101B		
	B19	T101BR				T301CD						
ocel, mäkké kovy	B25		B26		B25		B23		B23	T101BF	B26	
	P-47204	T101BF		T144DF		T144DF		T118BF				T144DF
	B52	T345X			B52	T345X	B52	T345X			B52	T345X
	B23		B27			T318B	B22	T118A			B25	T127D
kovové plechy	B22	T118A		T118AF	B23	T118B		T118EHM				
		T318A			B25	T127D		T118AHM				
		T118EHM										
nehrdzavejúca oceľ	B51	T123X					B51	T123X				
	B22	T118A		T118AF			B24	T118G				
hliník	P-05929	T118AF	B27				P-05929					
	B22		B27				B22					
		T118EHM					B24	T118EHM				
neželezné materiály	P-05929	T118AHM					P-05929	T118AHM				
	B22		B27		B26		B24		B21	T101A	B25	T127D
	B21	T101A	B26	T227D	B25	T127D						
						T318B						
sendičové materiály					B23	T118B						
	B51	T123X			B51	T123X	B51	T123X			B51	T123X
	B23	R118B	B26	T227D		T318B	B24	T118G	B21	T101A	B13	T111C
plasty	P-47204	T318AF		T118AF			B22	T118A				
	B21	T101A										
stavebné materiály, tvrdé plasty	B23		B26		B25		B23		P-47204	T318AF		
	B25				P-47210	T318BF	P-47404	T318AF				
	P-47204	T318AF										
keramika	B8		B15	T119B0	B12	T101D	B8		B21		B13	T111C
	B22		B18	T119B0		T301CD	B12	T101B			B25	T127D
obloženie	B11	T101B										T101DP
	B51	T123X			B51	T123X	B51	T123X	B51	T123X	B51	T123X
keramika	P-38766	T141HM	B26	T227D		T341HM	B23			T101BF	B23	
		T130			B60			T130			P-38766	T141HM
obloženie	B25	T127D			B61							T341HM
	P-38788	T130Riff	P-38788	T130Riff	P-38788	T130Riff	P-38794	T150Riff	P-38794	T150Riff	P-38788	T130Riff
obloženie	P-38794	T150Riff										
	P-47204	T318AF			P-47204							
obloženie	P-38794	T318BF										

# Porovnávací tabuľka

## Pílových lístov pre chvostové píly

MAKITA	AEG	BOSCH	DeWalt	FESTOOL	METABO	MILWAUKEE
P-04874	354791	S522EF	DW4810			48-00-5183
P-04880	354792	S922EF	DW4811	HSR 130/18bi	31454	48-00-5184
P-04896	354795	S522AF	DW4812	HSR 80/24bi		48-00-5185
P-04905	354796	S922AF	DW4813	HSR 130/24bi		48-00-5186
P-04911	354789	S922BF	DW4808	HSR 130/14bi	31491	48-00-5182
P-04927	361345		DW4809	HSR 180/14bi	31494	
P-04933	354793	S1122EF	DW4821	HSR 180/18bi	31493	
P-04949		S1122AF				
P-04977	354787	S422BF			31990	48-00-5162
P-04983				HSR 260/10bi		
P-05000	318127	S811H	DW4806			
P-05016	323802	S1344D	DW4804		31472	48-00-1079
P-05022	323801	S744D				48-00-1076
P-05044	323814	S641HM			31137	
P-05066		S2041HM			31819	
P-05088	354775	S611DF		HSR 130/6bi		48-00-5035

# Montážne kľúče









objednávacie číslo	popis	cena s DPH
781213-9	8 mm	1,58 €
781003-0	10 mm	1,45 €
781203-2	13 – 17 mm	2,38 €
782024-5	13 – 22 mm (2407)	2,96 €
781006-4	13 mm (RP0900)	1,33 €
SC00000499	14 – 17 mm (SC130DRA)	7,34 €
781010-3	19 mm (UT2204/1305)	2,25 €
781043-8	22 mm (4100NB/4105KB)	1,07 €
781012-9	23 mm	1,39 €
781030-7	24 mm	2,50 €

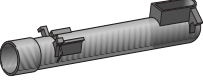

objednávacie číslo	popis	cena s DPH
JM23000130	(MLS100)	0,33 €
782223-9	10 mm	1,42 €
782023-7	13 – 16 mm (DCS230 T)	2,43 €
782230-2	13 – 3 mm (LF1000)	5,68 €
782212-4	13 mm	1,86 €
782210-8	17 mm	1,43 €
782209-3	9 mm (1923B)	1,69 €

# Priamočiare a akumulátorové priamočiare píly

obj. číslo	popis	DJV140D							cena s DPH
		4331D 4334D	DJV180D DJV181 DJV182 JV100D	JV101 JV102 JV103	4326 4327 4329	4350CT 4350FCT	4351CT 4351FCT	JV0600	
	193517-1 adaptér na vodiacu koľajnicu		•	•	•	•	•	•	23,35 €
	192732-4 kombinované vedenie vyrezávača kruhov a paralelný doraz		•	•	•	•	•	•	5,80 €
	192547-9 odsávací adaptér	•							2,64 €
	417853-4 odsávací adaptér		•			•	•		1,11 €
	457801-1			•					4,62 €
	783201-2	•		•	•				0,15 €
	783202-0 imbusový kľúč		•			•	•		0,24 €
	415524-7	•	•	•	•	•	•		0,21 €
	417852-6 plastová klzná doska (náhradný diel)		•			•	•		1,00 €
	141486-0		•						30,02 €
	824809-4 prepravný kufrík (bez vyobrazenia)					•	•		20,56 €
	P-04101				•				47,52 €
	B-48527 sada pilových listov (5 ks) do priamočiarej píly (drevo, železo, plast, laminátové podlahy)								13,96 €

# Pásové píly 2106, 2107, BPB180RFE

Rozmery všetkých pílových pásov: 1140 × 13 × 0,5mm

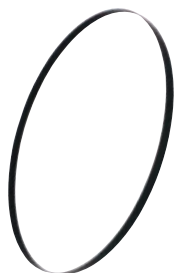

objednávacie číslo	materiál	zuby/palec	maximálny rezný výkon	použitie	ks/bal	cena s DPH
792567-9 •	uhlíková oceľová zliatina	6		drevo	3	37,33 €
792560-3 •	uhlíková oceľová zliatina	14	viac ako 5 mm	plasty, neželezné kovy, mäkká oceľ, liatina, oceľová liatina	3	38,24 €
792559-8 •	uhlíková oceľová zliatina	18	4–5 mm	plasty, neželezné kovy, mäkká oceľ, liatina, oceľová liatina	3	36,06 €
792558-0 •	uhlíková oceľová zliatina	24	menej ako 4 mm	plasty, neželezné kovy, mäkká oceľ, liatina, oceľová liatina	3	39,79 €
792557-2 •	rýchlorezná oceľ	14	viac ako 5 mm	plasty, neželezné kovy, mäkká oceľ, liatina, oceľová liatina, tvrdá oceľ, nehrdzavejúca oceľ	1	21,63 €
792556-4 •	rýchlorezná oceľ	18	4–5 mm	plasty, neželezné kovy, mäkká oceľ, liatina, oceľová liatina, tvrdá oceľ, nehrdzavejúca oceľ	1	22,88 €
194692-6 •	rýchlorezná oceľ	24	menej ako 4 mm	plasty, neželezné kovy, mäkká oceľ, liatina, oceľová liatina, tvrdá oceľ, nehrdzavejúca oceľ	1	21,38 €

- Pílový pás / zliatina uhlíkovej oceli
- Pílový pás / rýchlorezná oceľ

## Pásová píla DPB181

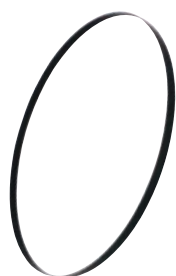

Objednávacie číslo	zuby/palec	max. rezný výkon	použitie	ks/bal	cena s DPH
B-40543	14	3–6 mm	plast, neželezné kovy, mäkká oceľ, liata oceľ	5	49,32 €
B-40559	18	2–3 mm	plast, neželezné kovy, mäkká oceľ, liata oceľ	5	59,69 €
B-40565	24	0–2 mm	plast, neželezné kovy, mäkká oceľ, liata oceľ	5	49,72 €

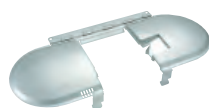

objednávacie číslo	názov	cena s DPH
197975-3	kryt pílového pásu	29,53 €



# Pásova píla 2106, 2107 FK, BPB180RFE

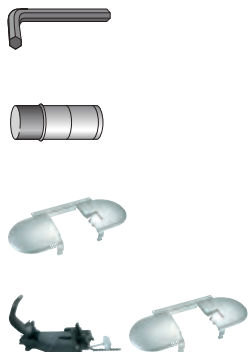

objednávacie číslo	názov	šírka	zuby/palec	ks/bal	cena s DPH
783202-0	imbusový kľúč 4	6	6	1	0,24 €
191897-9	rezací vosk	13	4	1	12,86 €
194070-0	*kryt pílového pásu (chráni pred poškodením)	16	4	1	101,24 €
410048-8	držiak imbusového kľúča 4			1	0,24 €

\*nevhodné pre BPB180RFE

## Dlabačka KC100



objednávacie číslo	popis	šírka (mm)	cena s DPH
P-22078	dlabacia reťaz	30	539,03 €
P-22084	dlabacia reťaz	40	357,51 €
P-22090	dlabacia reťaz	50	362,31 €
P-22109	vodiaca lišta	30	643,05 €
P-22115	vodiaca lišta	40	428,70 €
P-22121	vodiaca lišta	50	407,01 €
P-22137	reťaz	30	84,86 €
P-22143	reťaz	40	86,30 €
P-22159	reťaz	50	99,66 €

## Dlabačka 7104L

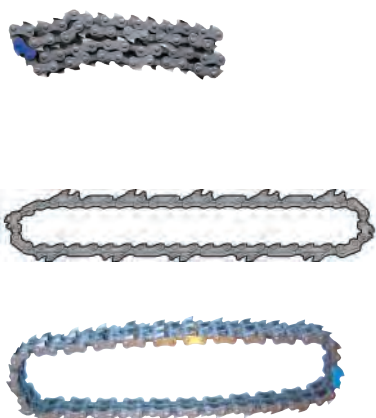

objednávacie číslo	popis	šírka (mm)	cena s DPH
A-16564	dlabacia reťaz	15	409,76 €
A-16570		16,5	453,43 €
A-16586		18	395,30 €
A-16592		21	468,19 €
A-16601		24	610,39 €
* A-16617		30	713,72 €
133571-3	vodiaca lišta	15-24	175,20 €
122235-4		30	157,10 €
221502-5	reťazovka k 30mm	30	23,28 €
182229-1	olej na reťaz 100ml		2,09 €
781204-0	montážny kľúč		2,83 €

\* Použitie len s vodiacou lištou 122235-4 a reťazovkou 221502-5



# Frézovanie

## TCT drážkovacia fréza

Prírodne a ručne opracované drevá a plasty.  
 Táto séria líčovacích fréz sa môže používať na profilovanie,  
 lícovanie, drážkovanie, vyrezávanie otvorov, rýh a zahlbovanie  
 do širokej palety rôznych materiálov.  
 Táto paleta líčovacích fréz kombinuje kvalitu, spoľahlivosť  
 a výkonnosť. Sú vyrobené z karbidu volfrámu, ktorý  
 zabezpečuje dlhšiu životnosť fréz.

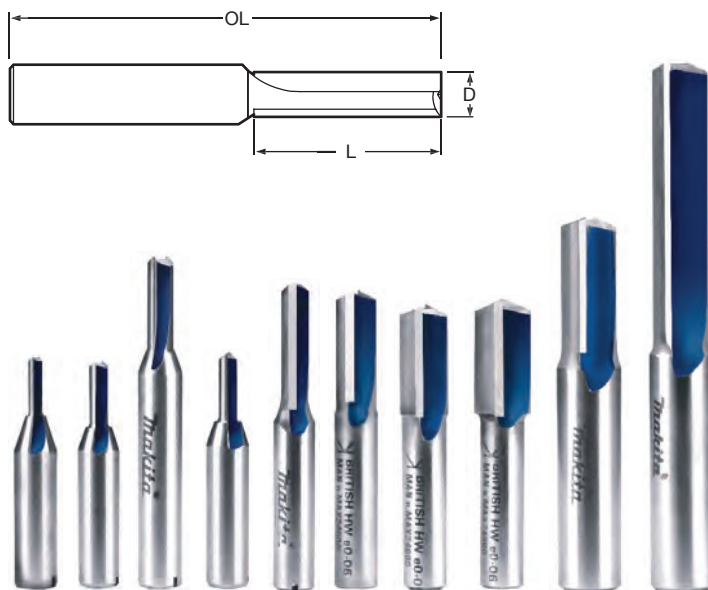

objednávacie číslo	D (mm)	L (mm)	OL (mm)	stopka (mm)	cena s DPH
P-78689	3	10	42	8	26,95 €
P-78695	4	10	42	8	26,95 €
P-78704	5	16	51	8	26,95 €
P-78710	6	16	51	8	27,68 €
P-78726	6	23	58	8	27,80 €
P-78732	8	20	52	8	29,16 €
P-78760	10	20	52	8	33,42 €
P-78776	12	20	52	8	32,69 €
P-78748	12	25	67	12	32,69 €
P-78754	12	50	92	12	56,26 €

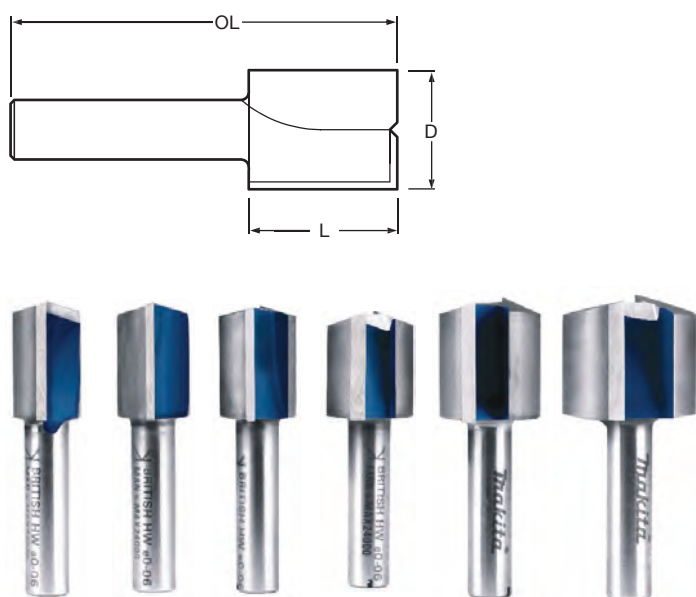

objednávacie číslo	D (mm)	L (mm)	OL (mm)	stopka (mm)	cena s DPH
P-78782	14	20	52	8	34,08 €
P-78798	15	20	52	8	32,69 €
P-78807	16	20	52	8	35,44 €
P-78813	18	20	52	8	36,50 €
P-78829	20	20	52	8	39,01 €
P-78835	24	20	52	8	32,51 €
P-78841	25	20	52	8	39,04 €



# Frézovanie

## TCT žliabkovacia fréza s ložiskom

Prírodne a ručne opracované drevo a plasty. Dva tvary produkované jednou frézou pomocou výmeny ložiska. Ložisko B16 odstraňuje drážky. Väčšie ložiská sú menej náchylné na vznik tepla a majú dlhšiu životnosť ako malé ložiská.

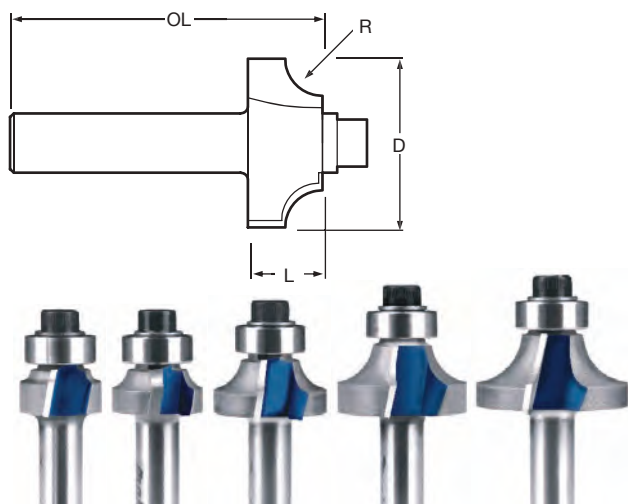

Tvary dosiahnuté pomocou zaobl'ovacích fréz.

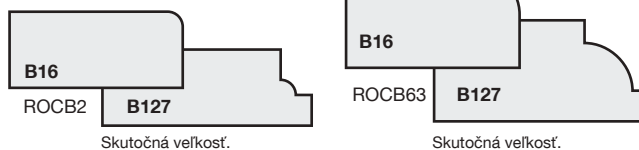

objednávacie číslo	D (mm)	R (mm)	L (mm)	OL (mm)	stopka (mm)	cena s DPH
P-78857	16,7	2	8	40	8	40,33 €
P-78863	18,7	3	8	40	8	43,60 €
P-78879	22	5	10	42	8	40,91 €
P-78885	25	6,3	12,7	45	8	37,83 €
P-78891	28,35	8	13	45	8	39,95 €
P-78900	31,7	9,5	15,8	48	8	44,42 €

## TCT zaobl'ovacia fréza s ložiskom

Prírodne a ručne opracované drevo a plasty. Táto séria obrysových fréz sa môže používať na profilovanie a vyhladzovanie profilov. Vďaka karbidovým hrotom je možné tieto frézy používať na širokú paletu rôznych materiálov. Táto séria je vyrábaná s menšími priermi.

objednávacie číslo	D (mm)	d (mm)	R (mm)	L (mm)	OL (mm)	stopka (mm)	cena s DPH
P-78916	18,7	12,7	2	8	40	6	39,13 €
P-78922	20	12,7	3	9	41	6	40,28 €

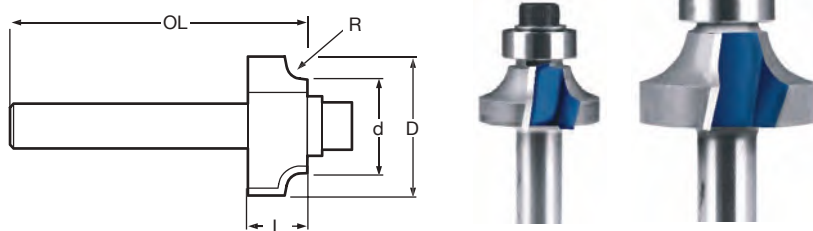

## TCT škárovacia fréza (Biskvit)

Prírodne a ručne opracované drevo a plasty. Umožňuje frézovanie biskvitových spojovacích štrbín do drevotriesky, MDF a tvrdých drev pomocou ručnej frézy.

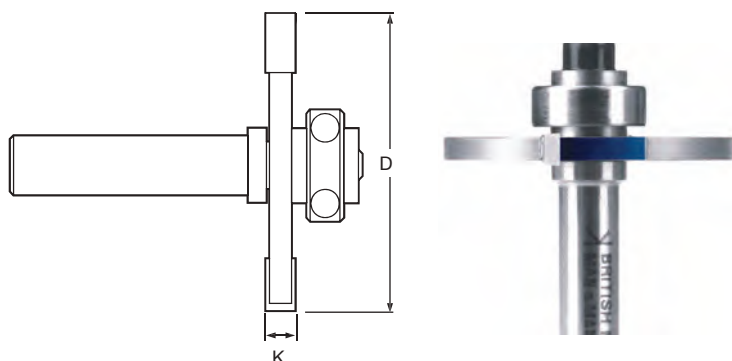

objednávacie číslo	D (mm)	K (mm)	stopka (mm)	cena s DPH
P-79120	40	4	8	36,26 €



# Frézovanie

## TCT žliabkovacia fréza

Prírodne a ručne opracované drevo a plasty.  
Kompletná séria fréz s možnosťou zahĺbenia s horným rezom. Väčšina fréz je kompatibilná so sériou používanou pri linkových spojoch.

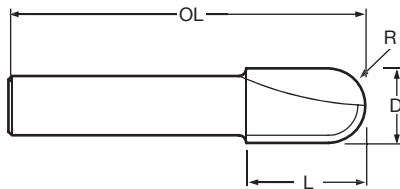

objednávacie číslo	D (mm)	R (mm)	L (mm)	OL (mm)	stopka (mm)	cena s DPH
P-78950	10	5	16	48	8	31,94 €
P-78966	12,7	6,3	17	49	8	32,82 €
P-78972	16	8	18	50	8	33,81 €
P-78944	20	10	18	50	8	38,68 €

## TCT profilová fréza (vnútorný úkos)

Prírodne a ručne opracované drevo a plasty.  
Umožňuje vytváranie pravouhlých rámov. Po zostavení a pri čapovaní sa nevyžaduje lícovanie.

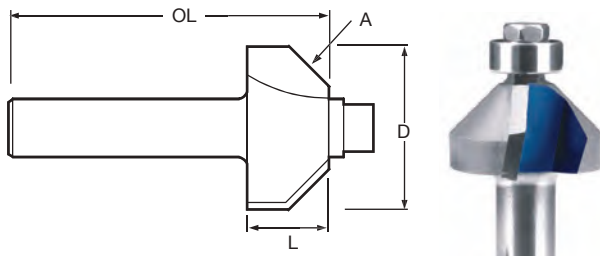

objednávacie číslo	D (mm)	A°	L (mm)	OL (mm)	stopka (mm)	cena s DPH
P-79083	22	45	11	43	8	31,43 €

## TCT falcovacia fréza (Fréza na poldrážku)

Prírodne a ručne opracované drevo a plasty.

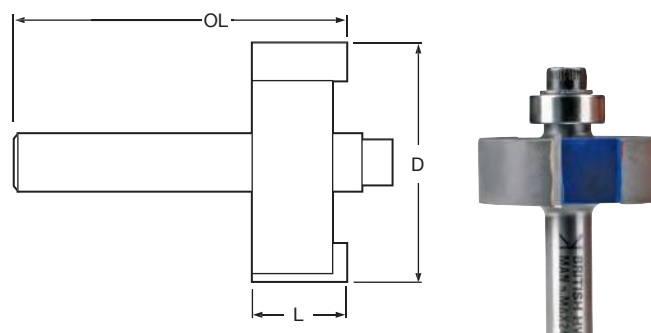

objednávacie číslo	D (mm)	L (mm)	OL (mm)	stopka (mm)	cena s DPH
P-79136	32	12,7	44	8	28,71 €



# Frézovanie

## TCT fazetová fréza s ložiskom (fréza na vyduté panely)

Prírodne a ručne opracované drevo a plasty.  
Panelové frézy na profilovanie alebo drážkovanie dekoratívnych šablón a panelov.  
Vynikajúce pre čelá zásuviek.

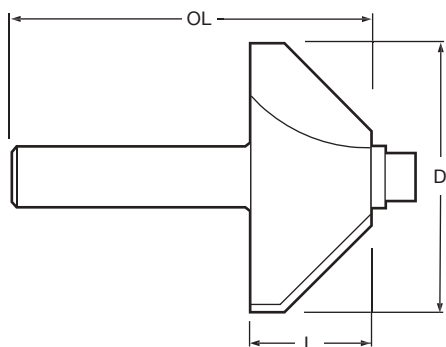

objednávacie číslo	D (mm)	L (mm)	OL (mm)	stopka (mm)	cena s DPH
P-79099	36	16	49	8	36,26 €

## TCT zarovnávací fréza (fréza na vodiace hrany)

Prírodne a ručne opracované drevo a plasty.  
Fréza s dlhšou životnosťou. Mimoriadne populárne frézy na frézovanie umakartu a laminátu.

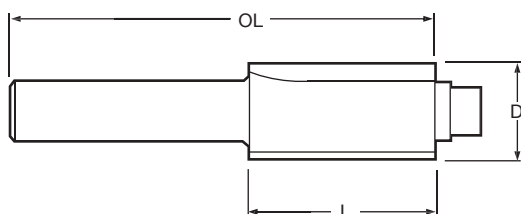

objednávacie číslo	D (mm)	L (mm)	OL (mm)	stopka (mm)	cena s DPH
P-78994	12,71	38,1	86	12	44,93 €
P-79005	12,7	25,4	57	8	31,27 €
P-79011	9,5	25	57	8	34,66 €

## TCT zarovnávací fréza (Fréza na vodiace hrany, malé priemery)

Prírodne a ručne opracované drevo a plasty.  
Vhodné na vyrezávanie otvorov a dier v karavanoch a v priemysle mobilných domov.

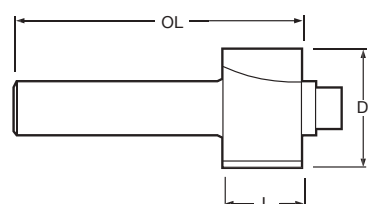

objednávacie číslo	D (mm)	L (mm)	OL (mm)	stopka (mm)	cena s DPH
P-79027	18	50	98	12	54,66 €
P-78988	18	12	50	8	37,92 €



# Frézovanie

## TCT žliabkovácia fréza s ložiskom

Prírodne a ručne opracované drevo a plasty. Táto séria obrysových fréz sa môže používať na profilovanie a úpravu hladkých povrchov na profile. Tieto frézy sa môžu vďaka karbidovým špičkám používať na rôzne druhy materiálov. Táto séria sa vyrába s menším priemerom.

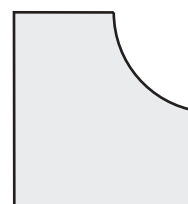
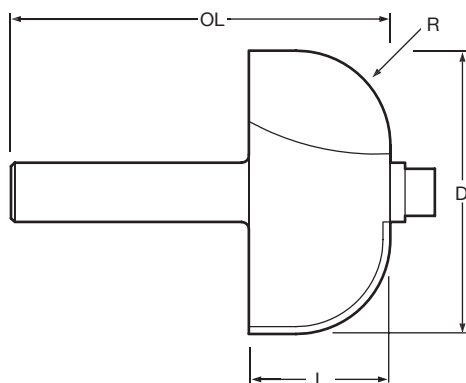

Dodávané s ložiskami B 127 a B 16.

**Tvar dosiahnutý pomocou frézy.**

CMC127 – Aktuálna veľkosť

objednávacie číslo	D (mm)	R (mm)	L (mm)	OL (mm)	stopka (mm)	cena s DPH
P-78938	36	12,7	19	51	8	46,90 €

## Ložiská pre frézy

objednávacie číslo frézy	typ ložiska	objednávacie číslo frézy	typ ložiska	objednávacie číslo frézy	typ ložiska	objednávacie číslo frézy	typ ložiska
P-78857	B127/B95	P-78916	B127	P-79011	B95/3.175	P-79083	B95/3.175
P-78863	B127/B95	P-78922	B127	P-79027	B18	P-79099	B127
P-78879	B127/B95	P-78938	B127	P-79033	B16/8	P-79120	B15
P-78885	B127/B95	P-78988	B18	P-79049	B16/8	P-79136	B127
P-78891	B127/B95	P-78994	B127	P-79055	B19/127		
P-78900	B127/B95	P-79005	B127	P-79077	B16		

## Ložiská pre frézy

objednávacie číslo	typ ložiska	popis	cena s DPH
P-79245	B127	D=12,7 d=6,35 H=4,8	8,81 €
P-79251	B15	D=15 d=6,35 H=5,3	11,42 €
P-79267	B16	D=16 d=6,35 H=5	10,44 €
P-79273	B16/8	D=16 d=8 H=5	10,44 €
P-79289	B18	D=18 d=6,35 H=5,5	11,42 €
P-79293	B19/127	D=19 d=12,7 H=4	15,67 €
P-79304	B95/3.175	D=9,5 d=3,175 H=4	14,69 €
P-79376	B95	D=9,5 d=6,35 H=3,2	16,19 €

D – vonkajší priemer  
d – vnútorný priemer  
H – výška

objednávacie číslo	popis	cena s DPH
P-79310	Inbusová skrutka M4x6	7,73 €



# Frézovanie

## TCT profilová vodiaca fréza s ložiskom

Prírodne a ručne opracované drevo a plasty. Sériu PGC fréz je vyrábaná s centrálnymi hrotmi a je ideálna na slepé profilovanie a zahlbovanie napríklad pri dvojvrstvovej lepenke. Tieto frézy majú vodiace ložiská určené na elimináciu hornej montážnej šablóny.

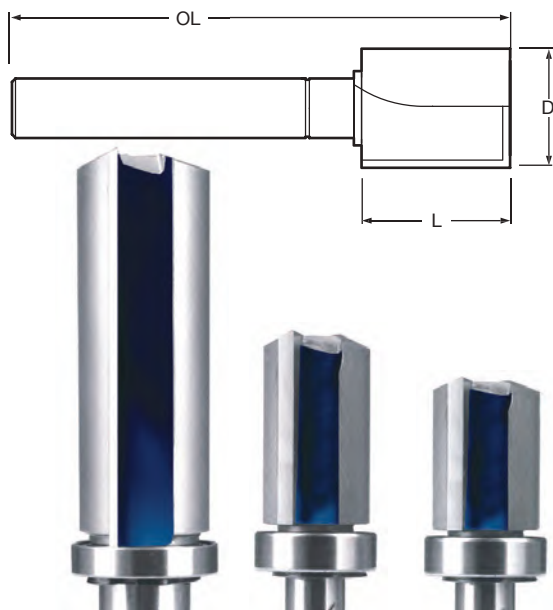

objednávacie číslo	D (mm)	L (mm)	OL (mm)	stopka (mm)	cena s DPH
P-79055	19	50	96	12	64,00 €
P-79049	16	25	72	8	52,09 €
P-79033	16	20	67	8	46,29 €

V porovnaní so sekačkou má séria s vodiacim profilom tú výhodu, že je schopná prechádzať cez vrstvu, ktorá má byť osekaná.

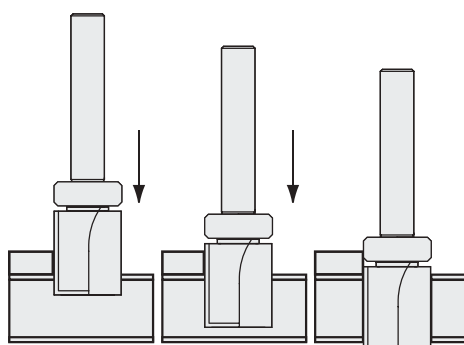

## TCT rybinová fréza

Prírodne a ručne opracované drevo a plasty. Štandardná veľkosť pre všetky aplikácie, napríklad frézovanie na rybinu, skrytú rybinu atď. K dispozícii s rysovacími ihlami (na vyžiadanie), čo umožňuje ich používanie spoločne s prenosnými vodiacimi prípravkami.

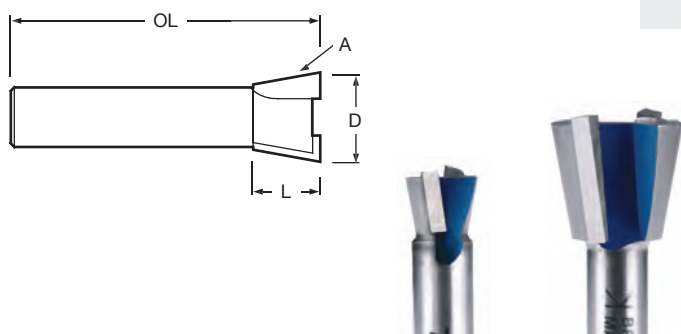

objednávacie číslo	D (mm)	A°	L (mm)	OL (mm)	stopka (mm)	cena s DPH
P-79108	12	10	10	42	8	28,71 €
P-79114	20	10	16	48	8	30,22 €





# Frézovanie

## TCT profilová fréza (drážkovanie – veľký prierez)

Prírodne a ručne opracovávané drevá a plasty.  
Panelové frézy na profilovanie alebo drážkovanie dekoratívnych tvarov a panelov. Dokonalé na čelá zásuviek.

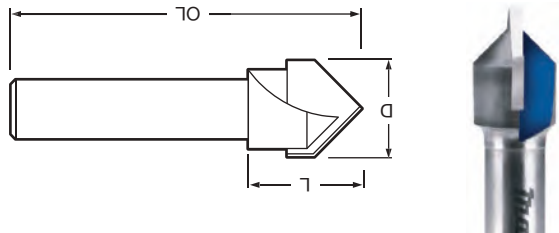

objednávacie číslo	D (mm)	L (mm)	OL (mm)	stopka (mm)	cena s DPH
P-79061	12,7	10	47	8	35,96 €

## TCT fazetová fréza s ložiskom (na hrany)

Prírodne a ručne opracovávané drevá a plasty.  
Táto fréza je najefektívnejšia na tvorbu sklonu a orezávanie plastov a laminátu.

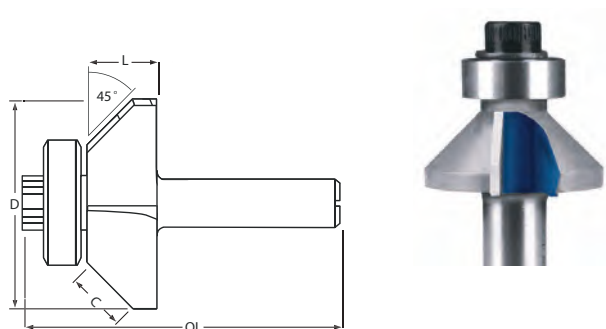

objednávacie číslo	D (mm)	L (mm)	OL (mm)	stopka (mm)	cena s DPH
P-79077	24	9	41	8	33,09 €



# Frézovanie



obj. číslo		priemer (mm)	dĺžka (mm)	celková dĺžka (mm)	rádus (mm)	hĺbka rezu (mm)	uhol (dg)	stopka (mm)	veľkosť ložiska (mm)	max. otáčky (rpm)	cena s DPH
D-47379		3	13	51	–	–	–	8	–	28000	6,31 €
D-47385		4	13	51	–	–	–	8	–	28000	6,96 €
D-47391		5	13	48	–	–	–	8	–	28000	6,20 €
D-47400		6	19	50,8	–	–	–	8	–	28000	6,40 €
D-47416		6	19	50,8	–	–	–	6	–	28000	7,93 €
D-47422		6	16	48	–	–	–	6	–	28000	6,59 €
D-47438		6	25	57	–	–	–	6	–	24000	7,10 €
D-47444		8	19	51	–	–	–	6	–	28000	7,38 €
D-47450		8	25,4	57,4	–	–	–	6	–	24000	6,78 €
D-47466		10	25,4	57,4	–	–	–	6	–	24000	7,25 €
D-47472		12	32	64	–	–	–	6	–	24000	22,97 €
D-47488		14	19	51	–	–	–	6	–	24000	8,39 €
D-47494		20	19	51	–	–	–	6	–	24000	10,38 €
D-47503		6	16	48	–	–	–	8	–	28000	6,59 €
D-47519		6	19	51	–	–	–	8	–	28000	6,74 €
D-47525		8	19	51	–	–	–	8	–	28000	7,46 €
D-47531		10	19	51	–	–	–	8	–	28000	7,67 €
D-47547		12	19	51	–	–	–	8	–	28000	7,11 €
D-47553		14	19	51	–	–	–	8	–	24000	7,65 €



# Frézovanie

obj. číslo	priemer (mm)	dĺžka (mm)	celková dĺžka (mm)	rádus (mm)	hĺbka rezu (mm)	uhol (dg)	stopka (mm)	veľkosť ložiska (mm)	max. otáčky (rpm)	cena s DPH
D-47569	16	19	51	–	–	–	8	–	24000	9,04 €
D-47575	18	19	51	–	–	–	8	–	24000	10,74 €
D-47581	20	19	51	–	–	–	8	–	24000	11,07 €
D-47597	22	25,4	57,2	–	–	–	8	–	24000	12,00 €
D-47606	24	25,4	57	–	–	–	8	–	24000	14,13 €
D-47612	8	25	70	–	–	–	12	–	24000	8,19 €
D-47628	10	25,4	70	–	–	–	12	–	24000	8,35 €
D-47634	12	32	73	–	–	–	12	–	24000	9,33 €
D-47640	14	32	73	–	–	–	12	–	24000	9,86 €
D-47656	16	32	73	–	–	–	12	–	24000	11,37 €
D-47662	19	32	73	–	–	–	12	–	24000	13,31 €
D-47678	22	32	73	–	–	–	12	–	24000	15,11 €
D-47684	25	32	73	–	–	–	12	–	18000	14,86 €
D-47690	9,5	26	66,9	–	–	–	6	9,5	24000	9,13 €
D-47709	12,7	13	56	–	–	–	6	12,7	28000	7,23 €
D-47715	12,7	26	68,5	–	–	–	6	12,7	24000	8,25 €
D-47721	9,5	26	67	–	–	–	8	9,5	24000	7,37 €
D-47737	12,7	13	55,7	–	–	–	8	12,7	28000	8,37 €
D-47743	12,7	26	68,5	–	–	–	8	12,7	24000	8,65 €
D-47759	12,7	26	68,5	–	–	–	8	12,7	24000	12,44 €
D-47765	12,7	38	91,4	–	–	–	12	12,7	24000	14,56 €
D-47771	6,35	19	65	–	–	–	6	–	28000	6,75 €
D-47787	6,35	19	65	–	–	–	8	–	28000	6,27 €
D-47793	9,5	26	75	–	–	–	12	–	24000	8,71 €
D-47802	6,35	12,7	44,5	3,2	–	–	6	–	28000	6,04 €
D-47818	9,5	12,7	44,5	4,8	–	–	6	–	28000	6,72 €
D-47824	12,7	19	51	6,35	–	–	6	–	28000	9,60 €
D-47830	6,35	12,7	44,5	3,2	–	–	8	–	28000	6,41 €
D-47846	9,5	12,7	44,5	4,8	–	–	8	–	28000	7,09 €
D-47852	12,7	19	51	6,35	–	–	8	–	28000	10,81 €







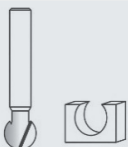

# Frézovanie

obj. číslo	priemer (mm)	dĺžka (mm)	celková dĺžka (mm)	rádus (mm)	hĺbka rezu (mm)	uhol (dg)	stopka (mm)	veľkosť ložiska (mm)	max. otáčky (rpm)	cena s DPH
D-47868	12,7	12,7	44,7	–	–	90dg	6	–	28000	7,82 €
D-47874	12,7	16	48	–	–	60dg	6	–	28000	7,41 €
D-47880	19	16	47,6	–	–	90dg	6	–	24000	9,47 €
D-47896	12,7	12,7	44,7	–	–	90dg	8	–	28000	6,79 €
D-47905	15,9	12,7	44	–	–	90dg	8	–	24000	8,32 €
D-47911	12,7	12,7	54	–	–	90dg	12	–	28000	10,95 €
D-47927	15,9	12,7	50,8	–	–	90dg	12	–	24000	14,98 €
D-47933	19	16	47,6	–	–	90dg	8	–	24000	9,47 €
D-47949	19	16	57,3	–	–	90dg	12	–	24000	18,56 €
D-47955	28,6	22,2	60,3	–	–	90dg	12	–	18000	34,50 €
D-47961	12,7	16	48	–	–	60dg	8	–	28000	8,03 €
D-47977	6,35	6,35	38,3	3,2	–	–	8	–	28000	8,00 €
D-47983	7,9	8	40	4	–	–	8	–	28000	6,38 €
D-47999	9,5	9,5	41,3	4,8	–	–	8	–	28000	6,98 €
D-48000	12,7	10	41,5	6,35	–	–	8	–	28000	7,31 €
D-48016	15,8	12,7	44,5	7,9	–	–	8	–	24000	9,45 €
D-48022	15,8	12,7	54	7,9	–	–	12	–	24000	9,63 €
D-48038	19	12,7	50,8	9,5	–	–	12	–	24000	11,03 €
D-48044	25,4	16	57	12,7	–	–	12	–	18000	16,97 €
D-48050	6,35	8	63,5	–	–	7.5 dg	8	–	28000	6,76 €
D-48066	9,5	9,5	40	–	–	9 dg	8	–	28000	7,12 €
D-48072	12,7	13	45	–	–	14 dg	8	–	28000	7,38 €
D-48088	15	14,3	52	–	–	15 dg	8	–	24000	8,49 €
D-48094	19	22,2	63,4	–	–	7 dg	12	–	24000	12,50 €
D-48103	25,4	22,2	64	–	–	14 dg	12	–	18000	12,86 €

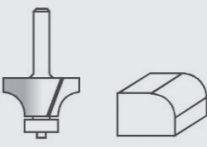

# Frézovanie

obj. číslo		priemer (mm)	dĺžka (mm)	celková dĺžka (mm)	rádus (mm)	hĺbka rezu (mm)	uhol (dg)	stopka (mm)	veľkosť ložiska (mm)	max. otáčky (rpm)	cena s DPH
D-48119		9,5	8,3	41,3	4,8	–	–	8	–	28000	7,05 €
D-48125		12,7	11,4	44,5	6,4	–	–	8	–	28000	7,80 €
D-48131		15,9	14,8	47,6	7,9	–	–	8	–	24000	9,95 €
D-48147		19	18,2	50,8	9,5	–	–	8	–	24000	10,41 €
D-48153		19	12,7	44,7	6,35	–	–	8	–	24000	11,26 €
D-48169		25,4	16	47,6	9,5	–	–	8	–	18000	13,50 €
D-48175		38,1	28,6	60,3	12,7	–	–	8	–	16000	22,52 €
D-48181		19	11	42,4	3,2	–	–	8	–	24000	11,49 €
D-48197		31,3	16	47,9	6,35	–	–	8	–	18000	16,68 €
D-48206		12,7	10	42	2,4	–	–	8	–	28000	8,06 €
D-48212		19	12,7	44,7	4	–	–	8	–	24000	11,52 €
D-48228		25,4	16	54	5,6	–	–	12	–	18000	14,92 €
D-48234		31,8	19	57	8,7	–	–	12	–	18000	23,47 €
D-48240		12,7	9,5	41,5	2	–	–	8	–	28000	8,85 €
D-48256		19	11	43,1	3,2	–	–	8	–	24000	11,14 €
D-48262		22	13	54	3,2	–	–	8	22,2	24000	18,51 €
D-48278		19	9,5	42,5	3,2	–	–	6	–	24000	8,09 €
D-48284		25,4	13,5	45,5	6,35	–	–	6	–	18000	11,91 €
D-48290		19	9,5	53,4	3,2	–	–	6	12,7	24000	10,14 €
D-48309		20,6	10	58,6	4	–	–	6	12,7	24000	11,10 €
D-48315		25,4	13,5	56,5	6,35	–	–	6	12,7	18000	13,74 €
D-48321		28,6	14,5	57,3	7,9	–	–	6	12,7	18000	13,67 €
D-48337		31,8	16,7	59,7	9,5	–	–	6	12,7	18000	15,36 €



# Frézovanie

obj. číslo	priemer (mm)	dĺžka (mm)	celková dĺžka (mm)	rádus (mm)	hĺbka rezu (mm)	uhol (dg)	stopka (mm)	veľkosť ložiska (mm)	max. otáčky (rpm)	cena s DPH
D-48343	17,3	8	51	2,3	–	–	8	12,7	24000	9,77 €
D-48359	19	9,5	53,4	3,2	–	–	8	12,7	24000	9,74 €
D-48365	20,7	10	52,3	4	–	–	8	12,7	24000	11,91 €
D-48371	22,2	12,7	55	4,8	–	–	8	12,7	24000	13,56 €
D-48387	25,4	13,5	56,5	6,35	–	–	8	12,7	18000	12,55 €
D-48393	28,6	14,5	57,3	7,9	–	–	8	12,7	18000	14,93 €
D-48402	31,8	16,7	59,7	9,5	–	–	8	12,7	18000	17,04 €
D-48418	38,1	19	62	12,7	–	–	8	12,7	16000	21,29 €
D-48424	50,8	25,4	76,2	19	–	–	12	12,7	14000	33,16 €
D-48430	17	8	49,1	2,3	–	–	6	9,5	24000	10,05 €
D-48446	19	9,5	51,6	3,2	–	–	6	9,5	24000	9,28 €
D-48452	20,3	10	50,5	4	–	–	6	9,5	24000	17,46 €
D-48468	22,2	12,7	53,2	4,8	–	–	6	9,5	24000	11,00 €
D-48474	28,6	14,5	55,5	7,9	–	–	6	9,5	18000	15,05 €
D-48480	17,3	8	49,1	2,3	–	–	8	9,5	24000	9,28 €
D-48496	19	9,5	51,6	3,2	–	–	8	9,5	24000	9,75 €
D-48505	20,7	10	50,5	4	–	–	8	9,5	24000	11,91 €
D-48511	22,2	13	53,2	4,8	–	–	8	9,5	24000	12,01 €
D-48527	25,4	13,5	54,7	6,35	–	–	8	9,5	18000	13,63 €
D-48533	28,6	14,5	55,5	7,9	–	–	8	9,5	18000	14,84 €
D-48549	31,8	17	57,9	9,5	–	–	8	9,5	18000	16,77 €
D-48555	38,1	19	60,2	12,7	–	–	8	9,5	16000	20,04 €
D-48561	50,8	25,4	74,5	19	–	–	12	9,5	14000	33,51 €
D-48577	28,6	12,7	50,8	4	–	–	8	12,7	18000	14,02 €

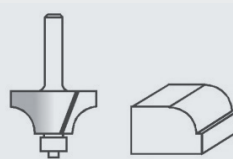
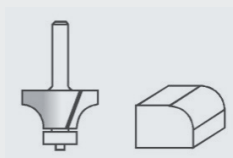



# Frézovanie

obj. číslo	priemer (mm)	dĺžka (mm)	celková dĺžka (mm)	rádus (mm)	hĺbka rezu (mm)	uhol (dg)	stopka (mm)	veľkosť ložiska (mm)	max. otáčky (rpm)	cena s DPH
D-48583	15,9	6,35	49,2	1,6	–	–	8	12,7	24000	12,52 €
D-48599	17,5	6,35	49	2,4	–	–	8	12,7	24000	12,47 €
D-48608	19	9,7	45,6	3,2	–	–	8	12,7	24000	10,99 €
D-48614	22,2	12,7	55,6	4,8	–	–	8	12,7	24000	11,57 €
D-48620	28,6	12,7	55,5	7,9	–	–	8	12,7	18000	14,94 €
D-48636	31,8	14	56	9,5	–	–	8	12,7	18000	17,24 €
D-48642	38,1	15,4	58,3	12,7	–	–	8	12,7	16000	22,06 €
D-48658	25,4	11	51	–	–	45dg	6	12,7	18000	13,52 €
D-48664	22,2	12,7	56,1	–	–	25dg	6	12,7	24000	10,93 €
D-48670	30,2	12,7	54,5	–	–	45dg	8	12,7	18000	15,26 €
D-48686	31,8	13,5	55,1	–	–	45dg	8	12,7	18000	16,53 €
D-48692	34,9	16	58,8	–	–	45dg	8	12,7	16000	18,77 €
D-48701	41,3	20	58,9	–	–	45dg	8	12,7	16000	25,74 €
D-48717	44,5	22,6	68,6	–	–	45dg	12	12,7	16000	24,81 €
D-48723	50,8	27	70,9	–	–	45dg	12	12,7	14000	32,05 €
D-48739	31,8	12,2	54,6	–	9,5	–	8	12,7	18000	16,33 €
D-48745	31,8	12,2	60,8	–	9,5	–	12	12,7	18000	16,98 €
D-48804	25,4	9,5	52,5	3,2	–	–	6	12,7	18000	14,44 €
D-48810	28,6	13	55,3	4	–	–	6	12,7	18000	12,79 €
D-48751	28,6	13	55,3	4	–	–	8	12,7	18000	12,02 €
D-48767	38,1	17,5	60	6,35	–	–	8	12,7	16000	21,85 €
D-48773	31,8	12,7	55,6	4,8	–	–	8	12,7	18000	18,83 €
D-48789	38,1	16	58,9	6,35	–	–	8	12,7	16000	23,08 €



















# Frézovanie

obj. číslo		priemer (mm)	dĺžka (mm)	celková dĺžka (mm)	rádus (mm)	hĺbka rezu (mm)	uhol (dg)	stopka (mm)	veľkosť ložiska (mm)	max. otáčky (rpm)	cena s DPH
D-48795		25,4	12,7	53,7	4,8	–	–	6	12,7	18000	13,82 €
D-48826		25,4	13	61,2	4,8	–	–	8	16	18000	19,52 €
D-48832		19	26	67,1	–	4,7	–	8	9,5	24000	22,23 €
D-48848		28,6	41	90,2	–	7,9	–	12	12,7	18000	33,26 €
D-48854		44,5	28,6	79,2	–	15,9	–	12	12,7	16000	38,61 €
D-48860		34,9	26	69,4	–	11,1	–	8	12,7	18000	32,44 €
D-48876		57,2	47,5	102,6	–	22,2	–	12	12,7	14000	55,39 €
D-48882		41	23,4	78,5	–	–	–	12	22	16000	44,93 €
D-48898		41	23,4	78,5	–	–	–	12	22	16000	64,21 €
D-48907		9,5	10,5	48	–	–	–	8	–	28000	6,46 €
D-48913		30,1	25,4	57,2	–	6,35	–	8	–	18000	26,14 €
D-48929		41,3	25,4	76,2	–	7,9	–	12	–	16000	31,37 €
D-48935		41	19	71	–	8,5	–	12	24	16000	36,30 €
D-48941		47,6	2	59	–	12,7	–	8	22,2	16000	17,95 €
D-48957		47,6	2,5	59	–	12,7	–	8	22,2	16000	17,95 €
D-48963		47,6	3	59	–	12,7	–	8	22,2	16000	17,02 €
D-48979		47,6	4	59	–	12,7	–	8	22,2	16000	15,98 €
D-48985		47,6	5	59	–	12,7	–	8	22,2	16000	16,49 €
D-48991		47,6	5,5	59	–	12,7	–	8	22,2	16000	18,15 €



# Štrbinová fréza

objednávacie číslo	popis	priemer/vrtanie (mm)	uhol zubov	počet zubov	hrúbka kotúča (mm)	cena s DPH	
	B-20644	štrbinová fréza	100 × 22	20°	6	4	23,74 €
	P-13605	pílový kotúč	110 × 20		30	4	44,52 €
	224280-6	vnútorná príruha 3901, PJ7000, DPJ180					3,40 €
	224505-8	vnútorná príruha 3901, PJ7000, DPJ180					2,89 €
	P-08838	spájač na drevo 1000 ks hrúbka 4 mm		N°0 – 46 × 15 mm			49,32 €
	P-08850	spájač na drevo 1000 ks hrúbka 4 mm		N°20 – 56 × 23,5 mm			51,31 €
	122474-6	vak na prach 3901					4,99 €
	123150-5	vak na prach PJ7000, DPJ180					4,98 €
	192349-3	adaptér na hadicu					7,10 €
	415252-4	koleno na odsávanie					1,11 €
	123149-0	doraz PJ7000, DPJ180					15,70 €
	122473-8	doraz 3901					41,89 €
	415579-2	vodidlo 3901, PJ7000, DPJ180					0,56 €
	782401-1	klúč 20 DPJ180, 3901, PJ7000					1,13 €

# Rotačná fréza



3,18 mm

6 mm



objednávacie číslo	popis	materiál	upínanie	cena s DPH
733229-0		sadrokartón, sadra	1/8"	2,27 €
733232-1	frézovací vrták kombinovaný vrták diamantový vrták	sadrokartón, sadra	1/4"	13,94 €
193483-2		drevo, plast	1/8"	5,28 €
324149-5			1/8"	34,60 €
763607-0	upínacia klieština		6 mm	2,74 €
763608-8			1/4"	2,58 €
763240-8	upínacia matica			2,97 €
781008-0	montážny kľúč			1,49 €
193448-4	vyrezávač kruhov			42,27 €
193449-2	odsávací adaptér			5,06 €
192219-6	ochranné okuliare			3,00 €
P-04101	prepravný kufrík			47,52 €

# Multifunkčná fréza RT0700



objednávacie číslo	názov	upínanie	cena s DPH
763636-3		6 mm	8,90 €
763637-1	upínacia klieština	1/4"	9,70 €
763618-5		8 mm	1,62 €
763615-1	upínacia matica		1,16 €
343577-5	vodiace puzdro	10 mm	0,50 €
122965-7	paralelný doraz		3,39 €
195564-8	držiak paralelného dorazu 122965-7 – nevyhnutný pre použitie základne pre zanorenie 195563-0		4,95 €
195136-9*	paralelný doraz s mikro nastavením		57,16 €
195138-5	sada držiakov paralelného dorazu 195136-8 – nevyhnutná pre použitie základne pre zanorenie 195563-0		4,09 €
122703-7	vedenie frézy		4,75 €
195559-1	odsávací adaptér		2,58 €
196612-6	vodiaca základňa		30,45 €
198985-3	sklopná základňa		29,83 €
195562-2	predsadená základňa		91,85 €
195563-0	základňa pre zanorenie		86,77 €
831327-5	univerzálna transportná taška		43,29 €

# Frézy s britmi osadenými tvrdokovom

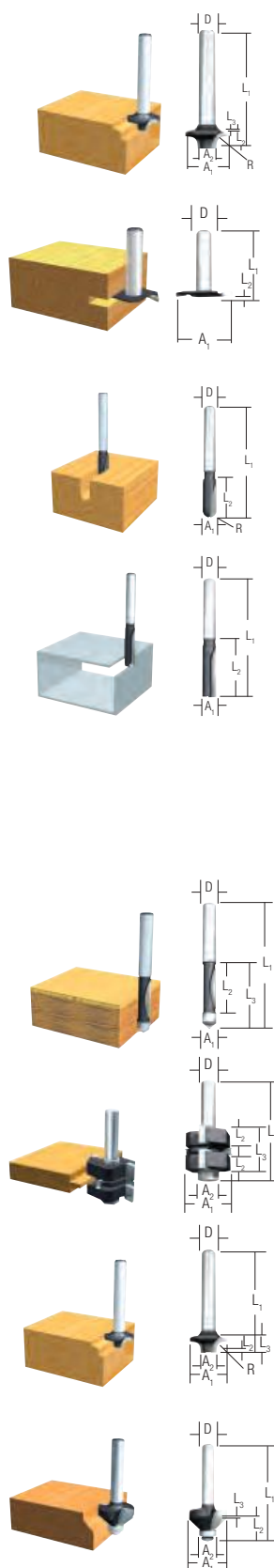

obj. číslo	popis	D	A1	A2	A3	A4	L1	L2	L3	L4	R	R1	R2	H	3612, 3612C RP1800FX RP2300FCX	3620, RP0900 RP0910, RP1110C	3707, 3708, 3709, 3710	cena s DPH
D-09357	fréza na zaoblené hrany	6	20	8			45	10	4		4				•	•	•	20,78 €
D-09363		6	25	9			48	13	5		8				•	•	•	26,94 €
D-07892		12	12				60	30							•			48,37 €
D-09260	drážkovacia fréza	6	8				50	18							•	•	•	8,20 €
73323 9-7		6	6				50	18							•	•	•	9,96 €
79312 6-2		8	8				60	25							•	•		17,34 €
D-09329	drážkovacia fréza – tvar U	6					50	18		3					•	•	•	13,32 €
D-16988	frézy na hliník	6	10				50	20							•	•	•	11,43 €
D-10584	lícovacia fréza	8					60	20	35						•	•		13,25 €
D-12027	pérová fréza	12	38				61	4	20						•			43,16 €
D-09422		6	15	8			37	7	3,5		3				•	•	•	19,11 €
D-09444	fréza na oblé hrany	6	21	8			40	10	3,5		6				•	•	•	25,22 €
D-09547		6	26	12	8		42	12	4,5		8				•	•	•	25,17 €
D-09488	fréza na skosené hrany	6	26	8			42	12					45°		•	•	•	21,21 €

# Príslušenstvo frézy

objednávacie číslo	popis	priemer	A	B	C	3612, MT362, 3612C, RP1800FX, RP2300FCX	3620, RP0900, MT361	3707, 3708	3709, 3710	RP0910, RP1110C	cena s DPH	
343577-5	vodiace puzdro	10	8	10	10			•			0,50 €	
164379-4		9,5	7,7	9,5	11,5	•	•				14,05 €	
164775-6		11	9	11	13	•	•				13,73 €	
164388-3		12	10	12	9	•	•				12,33 €	
164776-4		12,7	11	12,7	13	•	•				13,00 €	
344364-5		16	14,5	16	13	•	•				1,89 €	
164393-0		20	18	20	13	•	•				14,16 €	
164470-8		27	24	27	13	•	•				10,94 €	
163080-8		29	25	29	15	•	•				11,10 €	
164471-6		30	27	30	13	•	•				12,46 €	
165046-4		40	37	40	13	•	•				12,71 €	
193331-5		11	9	11	11,5					•	11,69 €	
193334-9		16	14,5	16	11,5					•	14,23 €	
193340-4		24	22	24	13					•	16,58 €	
193336-5		27	24	27	13					•	15,71 €	
193338-1		30	29	30	13					•	16,71 €	
193339-9		40	37	40	13					•	15,24 €	
763607-0		upínacia klieština	6						•			2,74 €
763662-2			6							•		3,10 €
763636-3	6						•				8,90 €	
763618-5	8						•				1,62 €	
763628-2	12						•				14,79 €	
763808-0	12-6,35						•				3,37 €	
763801-4	upínacie puzdro	6				•					2,91 €	
763804-8		8				•					2,87 €	
763805-6		3/8"				•					3,23 €	
763807-2		10				•					3,53 €	
193180-0	sada upínacích klieštín	6								•	24,73 €	
193178-7		8								•	24,25 €	
193904-4	vedenie frézy							•			71,95 €	
122703-7	vedenie frézy								•		4,75 €	
122256-6	vedenie frézy					•					24,33 €	





# Príslušenstvo frézy

objednávacie číslo	popis	3612, 3612C, RP1800FX, RP2300FCX	3620, RP0900	3707, 3708	3709, 3710	RP0910, RP1110C	cena s DPH
	123022-4 držiak vedenia frézy	•					5,28 €
	122704-5 paralelný doraz				•		3,29 €
	164834-6 paralelný doraz		•			•	4,07 €
	342428-9 paralelný doraz	•					3,98 €
	195136-9* paralelný doraz s mikro nastavením						57,16 €
	195138-5* sada držiakov k paralelnému dorazu						4,09 €

\* pri frézach RP1110C/RP0910 a RP0900 je možné použiť len s držiakom 195138-5

# Príslušenstvo frézy

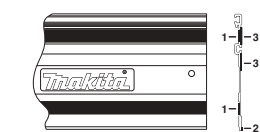
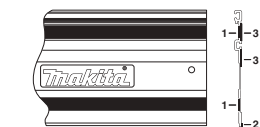
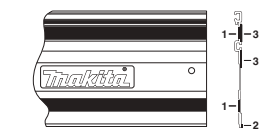

objednávacie číslo	popis	3612, 3612C, RP1800FX, RP2300FCX	3620, RP0900	3707, 3708	3709, 3710	RP0910, RP1110C	cena s DPH
194579-2**	adaptér pre pripojenie k vodiacej lište	•				•	41,45 €
199140-0	vodiaca lišta 1000 mm						38,61 €
199141-8	vodiaca lišta 1500 mm						50,90 €
194367-7	vodiaca lišta 3000 mm	•					174,99 €
198885-7	spojka vodiacej lišty						23,64 €
P-20177		•					48,87 €
194385-5	skrutková svorka (pár)	•					33,83 €
193517-1	adaptér k vodiacej lište	•					23,35 €
423359-2	náhradná guma k lište 1400 mm náhradná guma k lište 1900 mm náhradná guma k lište 3000 mm						2,80 €
423386-9							4,33 €
423360-7							7,01 €
423361-5	náhradná penová hmota k lište 1400 mm náhradná penová hmota k lište 1900 mm náhradná penová hmota k lište 3000 mm						6,86 €
451330-6							5,14 €
423362-3							13,93 €
413101-9	náhradná kľzná páska k lište 1400 mm náhradná kľzná páska k lište 1900 mm náhradná kľzná páska k lište 3000 mm						3,88 €
423390-8							8,07 €
413102-7							6,72 €
415412-8	odsávací adaptér	•					4,54 €
122615-4	odsávací adaptér					•	6,79 €
194934-8	odsávací adaptér	RP1800FX, RP2300FCX					9,47 €
192035-6	odsávací adaptér	3620					18,59 €
194733-8	odsávací adaptér	RP0900					3,10 €
122609-9	odsávací adaptér					•	4,64 €

\*\* pri frézach RP1110C/RP0910 a RP0900 je možné použiť len s držiakom 195138-5

# Vibračné brúsky

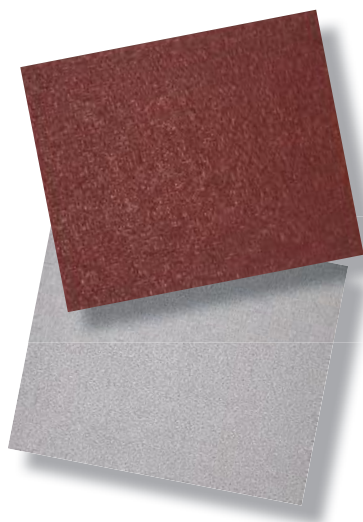

## PRÍSLUŠENSTVO NA BRÚSENIE

### Brúsne papiere

V našej ponuke nájdete dva typy brúsnych papierov:

**Červené** – brúsne papiere s dlhou životnosťou vhodné na brúsenie dreva, farebných kovov, plastov, kovu alebo kameňa. Tieto papiere sú štandardne dodávané perforované alebo neperforované v širokej škále zrnitosti, veľkostí a balení.

**Biele** – brúsne papiere s dlhou životnosťou vhodné na brúsenie dreva, farebných kovov, plastov, kovu alebo kameňa. Tieto brúsne papiere sú ideálne na konečnú úpravu materiálov – brúsenie farieb a lakov. Brúsne papiere sú štandardne dodávané perforované alebo neperforované v širokej škále zrnitosti, veľkostí a balení.

## Použitie brúsnych papierov

farba	drevo	drevené materiály	kov	kameň	plasty	konečná povrchová úprava (farba/lak)
červená	••	••	••	••	••	•
biela	•	•	•	•	•	••

•• Ideálne použitie / • Možné použitie

## Každý obal brúsnych papierov Makita obsahuje nasledujúce informácie

**Rozloženie dier na odsávanie prachu**

**Uchytenie (v tomto prípade na suchý zips)**

**Typ stroja (v tomto prípade excentrická brúska)**

**Odporúčaný materiál (v tomto prípade drevo, kov a dokončovacie práce)**

**Zrnitosť**

**Počet kusov v balení**

**Objednávacie číslo**

**Rozmer brúsneho papiera**

**Značky, pri ktorých je možné tiež použiť papier**

- Vibračné brúsky
- Excentrické brúsky
- Pásové brúsky
- Vibračné brúsky
- Multi Tool
- Elektrické pilníky
- Kov
- Farby, lak
- Odstraňovanie hrdzí
- Suchý zips
- Dokončovacie práce



# Vibračné brúsky – malé vibračné brúsky

## Brúsny papier 114 × 140 mm, neperforovaný

Vhodné pre farebné kovy, plasty, drevo, drevo s klincami, kov, kameň



objednávacie číslo	popis	zrornosť	ks/bal	BO4555	BO4556	BO4557	BO4565	BO4563	cena s DPH
P-36398	brúsny papier	40	10	•	•	•			2,84 €
P-32904		60	10	•	•	•			2,51 €
P-36407		80	10	•	•	•			2,42 €
P-32910		100	10	•	•	•			2,25 €
P-32926		120	10	•	•	•			2,25 €
P-32932		150	10	•	•	•			2,25 €
P-36413		180	10	•	•	•			2,25 €
P-36429		240	10	•	•	•			2,25 €
P-36441		60	50	•	•	•			11,39 €
P-36479		120	50	•	•	•			8,42 €
P-36485		150	50	•	•	•			8,42 €

## Brúsny papier 114 × 140 mm, neperforovaný

Vhodné pre laky a farby, farebné kovy, plasty, drevo, drevo s klincami, kov, kameň.



objednávacie číslo	popis	zrornosť	ks/bal	BO4555	BO4556	BO4557	BO4565	BO4563	cena s DPH
P-36516	brúsny papier	40	10	•	•	•			3,62 €
P-36522		60	10	•	•	•			3,23 €
P-36538		80	10	•	•	•			3,13 €
P-36544		100	10	•	•	•			3,07 €
P-36550		120	10	•	•	•			3,07 €
P-36566		150	10	•	•	•			3,07 €
P-36572		180	10	•	•	•			3,07 €
P-36588		240	10	•	•	•			3,07 €
P-36603		60	50	•	•	•			14,75 €
P-36619		80	50	•	•	•			12,27 €
P-36625		100	50	•	•	•			11,85 €
P-36647		150	50	•	•	•			11,85 €
P-36669		240	50	•	•	•			11,85 €

## Brúsny papier na suchý zips 114 × 102 mm, perforovaný, 6 otvorov

Vhodné pre farebné kovy, plasty, drevo, drevo s klincami, kov, kameň.



objednávacie číslo	popis	zrornosť	ks/bal	BO4555	BO4556	BO4557	BO4565	BO4563	cena s DPH
P-33087	brúsny papier	40	10	•	•	•			3,62 €
P-33093		60	10	•	•	•			3,49 €
P-33102		80	10	•	•	•			3,39 €
P-33118		100	10	•	•	•			3,36 €
P-33124		120	10	•	•	•			3,36 €
P-33130		150	10	•	•	•			3,36 €
P-33146		180	10	•	•	•			3,36 €
P-33152		240	10	•	•	•			3,36 €
P-33168		320	10	•	•	•			3,36 €
P-42416		40	50	•	•	•			15,28 €
P-42422		60	50	•	•	•			14,62 €
P-42438		80	50	•	•	•			14,23 €
P-42444		100	50	•	•	•			14,00 €
P-42450		120	50	•	•	•			14,00 €
P-42466		150	50	•	•	•			14,00 €
P-42472		180	50	•	•	•			14,00 €
P-42488		240	50	•	•	•			14,00 €
P-42494		240	50	•	•	•			14,00 €



# Vibračné brúsky – malé vibračné brúsky

## Brúsny papier na suchý zips 114 × 102 mm, perforovaný 6 otvorov

Vhodné pre laky a farby, farebné kovy, plasty, drevo, drevo s klincami, kov, kameň.

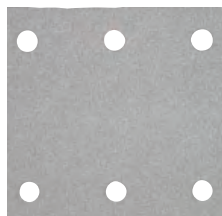

objednávacie číslo	popis	zrntosť	ks/bal	BO4555	BO4556	BO4557	BO4565	BO4563	cena s DPH
P-35807	brúsny papier	40	10	•		•	•		4,18 €
P-35813		60	10	•		•	•		3,95 €
P-35829		80	10	•		•	•		3,85 €
P-35835		100	10	•		•	•		3,79 €
P-35841		120	10	•		•	•		3,79 €
P-35857		150	10	•		•	•		3,79 €
P-35863		180	10	•		•	•		3,79 €
P-35879		240	10	•		•	•		3,79 €
P-35885		320	10	•		•	•		3,79 €
P-42503		40	50	•		•	•		18,15 €
P-42519		60	50	•		•	•		17,04 €
P-42525		80	50	•		•	•		16,52 €
P-42531		100	50	•		•	•		16,16 €
P-42547		120	50	•		•	•		16,16 €
P-42553		150	50	•		•	•		16,16 €
P-42569		180	50	•		•	•		16,16 €
P-42575		240	50	•		•	•		16,16 €
P-42581		320	50	•		•	•		16,16 €

## Brúsny papier na suchý zips 95 × 95 × 95 mm, perforovaný 6 otvorov

Vhodné pre farebné kovy, plasty, drevo, drevo s klincami, kov, kameň.



objednávacie číslo	popis	zrntosť	ks/bal	BO4555	BO4556	BO4557	BO4565	BO4563	cena s DPH
P-33255	brúsny papier	40	10				•	•	2,87 €
P-33261		60	10				•	•	2,81 €
P-33277		80	10				•	•	2,77 €
P-33283		100	10				•	•	2,71 €
P-33299		120	10				•	•	2,71 €
P-33308		150	10				•	•	2,71 €
P-33314		180	10				•	•	2,71 €
P-33320		240	10				•	•	2,71 €
P-33336		320	10				•	•	2,71 €
P-42597		40	50				•	•	11,62 €
P-42606		60	50				•	•	11,26 €
P-42612		80	50				•	•	11,00 €
P-42628		100	50				•	•	10,77 €
P-42634		120	50				•	•	10,77 €
P-42640		150	50				•	•	10,77 €
P-42656		180	50				•	•	10,77 €
P-42662		240	50				•	•	10,77 €
P-42678		320	50				•	•	10,77 €

## Brúsny papier na suchý zips 95 × 95 × 95 mm, perforovaný 6 otvorov

Vhodné pre laky a farby, farebné kovy, plasty, drevo, drevo s klincami, kov, kameň.



objednávacie číslo	popis	zrntosť	ks/bal	BO4555	BO4556	BO4557	BO4565	BO4563	cena s DPH
P-42684	brúsny papier	40	10				•	•	2,87 €
P-42690		60	10				•	•	2,74 €
P-42709		80	10				•	•	2,74 €
P-42715		100	10				•	•	2,68 €
P-42721		120	10				•	•	2,68 €
P-42737		150	10				•	•	2,68 €
P-42743		180	10				•	•	2,68 €
P-42759		240	10				•	•	2,68 €
P-42765		320	10				•	•	2,61 €
P-42771		40	50				•	•	11,59 €
P-42787		60	50				•	•	10,97 €
P-42793		80	50				•	•	10,84 €
P-42802		100	50				•	•	10,61 €
P-42818		120	50				•	•	10,61 €
P-42824		150	50				•	•	10,61 €
P-42830		180	50				•	•	10,61 €
P-42846		240	50				•	•	10,61 €
P-42852		320	50				•	•	10,31 €



# Vibračné brúsky – malé vibračné brúsky

Brúsny papier na suchý zips 100 × 240 mm, perforovaný, 10 otvorov

Vhodné pre farebné kovy, plasty, drevo, drevo s klincami, kov, kameň.

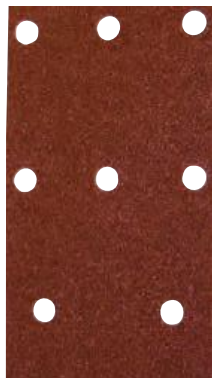

objednávacie číslo	popis	zrornosť	ks/bal	BO4555	BO4556	BO4557	BO4565	BO4563	cena s DPH
P-42868	brúsny papier	40	10	•		•	•		5,12 €
P-42874		60	10	•		•	•		4,93 €
P-42880		80	10	•		•	•		4,83 €
P-42896		100	10	•		•	•		4,73 €
P-42905		120	10	•		•	•		4,73 €
P-42911		150	10	•		•	•		4,73 €
P-42927		180	10	•		•	•		4,73 €
P-42933		240	10	•		•	•		4,73 €
P-42949		40	50	•		•	•		22,78 €
P-42955		60	50	•		•	•		21,84 €
P-42961		80	50	•		•	•		21,38 €
P-42977		100	50	•		•	•		20,92 €
P-42983		120	50	•		•	•		20,92 €
P-42999		150	50	•		•	•		20,92 €
P-43000		180	50	•		•	•		20,92 €
P-43016		240	50	•		•	•		20,92 €

## Ďalšie príslušenstvo

objednávacie číslo	popis	ks/bal	BO4555	BO4556	BO4557	BO4565	BO4563	cena s DPH
450066-4	dierovacia doska	1	•	•	•			0,81 €
135246-0	papierové vrečko vrátane držiaku	1	•	•	•	•	•	4,71 €
193293-7	papierové vrečko / balenie	5	•	•	•	•	•	6,97 €
P-13839	odsávací adaptér k vysávačom	1	•	•	•	•	•	7,96 €
02300B0N	sacia hadica Ø 30 mm – 440	1	•	•	•	•	•	72,88 €
P-70487	sacia hadica Ø 27 mm – 446L/447L	1	•	•	•	•	•	83,47 €
824806-0	transportný kufrík	1	•	•	•	•		13,81 €

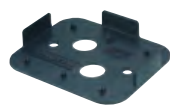





# Vibračné brúsky – malé vibračné brúsky

## Brúsny papier 93 × 228 mm, perforovaný

Vhodné pre farebné kovy, plasty, drevo, drevo s klincami, kov, kameň.



objednávacie číslo	popis	zrnitosť	ks/bal	9036	BO3700, BO3710, BO3711	BO4900V	9046	cena s DPH
P-31837	brúsny papier	40	10	•	•			2,74 €
P-31843		60	10	•	•			2,55 €
P-31859		80	10	•	•			2,48 €
P-31865		100	10	•	•			2,45 €
P-36011		120	10	•	•			2,45 €
P-36027		150	10	•	•			2,45 €
P-36033		180	10	•	•			2,45 €
P-36049		240	10	•	•			2,45 €
P-36055		40	50	•	•			10,90 €
P-36061		60	50	•	•			9,92 €
P-36077		80	50	•	•			9,66 €
P-36083		100	50	•	•			9,40 €
P-36099		120	50	•	•			9,40 €
P-36108		150	50	•	•			9,40 €
P-36114		180	50	•	•			9,40 €
P-36120		240	50	•	•			9,40 €

## Brúsny papier na suchý zips 93 × 185 mm, perforovaný, suchý zips

Vhodné pre farebné kovy, plasty, drevo, drevo s klincami, kov, kameň.



objednávacie číslo	popis	zrnitosť	ks/bal	9036	BO3700, BO3710, BO3711	BO4900V	9046	cena s DPH
P-31871	brúsny papier	40	10	•	•			4,28 €
P-31887		60	10	•	•			3,85 €
P-31893		80	10	•	•			3,75 €
P-31902		100	10	•	•			3,62 €
P-35891		120	10	•	•			3,62 €
P-35900		150	10	•	•			3,62 €
P-35916		180	10	•	•			3,62 €
P-35922		240	10	•	•			3,62 €
P-35938		40	50	•	•			18,64 €
P-35944		60	50	•	•			16,42 €
P-35950		80	50	•	•			15,90 €
P-35966		100	50	•	•			15,41 €
P-35972		120	50	•	•			15,41 €
P-35988		150	50	•	•			15,41 €
P-35994		180	50	•	•			15,41 €

## Brúsny papier 93 × 228 mm, neperforovaný

Vhodné pre farebné kovy, plasty, drevo, drevo s klincami, kov, kameň.



objednávacie číslo	popis	zrnitosť	ks/bal	9036	BO3700, BO3710, BO3711	BO4900V	9046	cena s DPH
P-36136	brúsny papier	40	10	•	•			2,38 €
P-32948		60	10	•	•			2,15 €
P-36142		80	10	•	•			2,12 €
P-32954		100	10	•	•			2,06 €
P-36158		120	10	•	•			2,06 €
P-32960		150	10	•	•			2,06 €
P-36164		180	10	•	•			2,06 €
P-36170		240	10	•	•			2,06 €
P-36192		60	50	•	•			8,06 €
P-36217		100	50	•	•			7,57 €
P-36245		180	50	•	•			7,57 €





# Vibračné brúsky – malé vibračné brúsky

## Brúsny papier 115 x 280 mm, neperforovaný

Vhodné pre farebné kovy, plasty, drevo, drevo s klincami, kov, kameň.



objednávacie číslo	popis	zrornosť	ks/bal	9036	BO3700, BO3710, BO3711	BO4900V	9046	cena s DPH
P-36267	brúsny papier	40	10			•	•	3,98 €
P-32976		60	10			•	•	3,36 €
P-36273		80	10			•	•	3,20 €
P-32982		100	10			•	•	3,07 €
P-36289		120	10			•	•	3,07 €
P-32998		150	10			•	•	3,07 €
P-36295		180	10			•	•	3,07 €
P-36304		240	10			•	•	3,07 €
P-36310		40	50			•	•	16,74 €
P-36326		60	50			•	•	13,94 €
P-36332		80	50			•	•	13,12 €
P-36348		100	50			•	•	12,53 €
P-36354		120	50			•	•	12,53 €
P-36360		150	50			•	•	12,53 €
P-36382		240	50			•	•	12,53 €

## Brúsny papier 115 x 280 mm, perforovaný, 14 otvorov

Vhodné pre farebné kovy, plasty, drevo, drevo s klincami, kov, kameň.

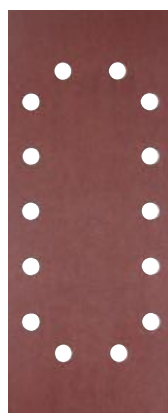

objednávacie číslo	popis	zrornosť	ks/bal	9036	BO3700, BO3710, BO3711	BO4900V	9046	cena s DPH
P-33009	brúsny papier	40	10			•	•	3,53 €
P-33015		60	10			•	•	3,23 €
P-33021		80	10			•	•	3,13 €
P-33037		100	10			•	•	3,07 €
P-33043		120	10			•	•	3,07 €
P-33059		150	10			•	•	3,07 €
P-33065		180	10			•	•	3,07 €
P-33071		240	10			•	•	3,07 €
P-35651		60	50			•	•	13,28 €
P-35667		80	50			•	•	12,83 €
P-35689		120	50			•	•	12,53 €
P-35695		150	50			•	•	12,53 €
P-35710		240	50			•	•	12,53 €

## Brúsny papier so suchým zipsom 115 x 229 mm, perforovaný 10 otvorov

Vhodné pre farebné kovy, plasty, drevo, drevo s klincami, kov, kameň.



objednávacie číslo	popis	zrornosť	ks/bal	9036	BO3700, BO3710, BO3711	BO4900V	9046	cena s DPH
P-33174	brúsny papier	40	10			•	•	5,58 €
P-33180		60	10			•	•	5,29 €
P-33196		80	10			•	•	5,03 €
P-33205		100	10			•	•	4,93 €
P-33211		120	10			•	•	4,93 €
P-33227		150	10			•	•	4,93 €
P-33233		180	10			•	•	4,93 €
P-33249		240	10			•	•	4,93 €
P-35726		40	50			•	•	25,10 €
P-35732		60	50			•	•	23,70 €
P-35748		80	50			•	•	22,29 €
P-35754		100	50			•	•	21,84 €
P-35760		120	50			•	•	21,84 €
P-35776		150	50			•	•	21,84 €
P-35782		180	50			•	•	21,84 €
P-35798		240	50			•	•	21,84 €



# Vibračné brúsky – malé vibračné brúsky

Brúsny papier so suchým zipsom 115 × 229 mm, perforovaný 14 otvorov

Vhodné pre farebné kovy, plasty, drevo, drevo s klincami, kov, kameň.



objednávacie číslo	popis	zrornosť	ks/bal	9036	BO3700, BO3710, BO3711	BO4900V	9046	cena s DPH
P-43022	brúsny papier	40	10			•	•	5,58 €
P-43038		60	10			•	•	5,29 €
P-43044		80	10			•	•	5,03 €
P-43050		100	10			•	•	4,93 €
P-43066		120	10			•	•	4,93 €
P-43072		150	10			•	•	4,93 €
P-43088		180	10			•	•	4,93 €
P-43094		240	10			•	•	4,93 €
P-43103		40	50			•	•	25,10 €
P-43125		80	50			•	•	22,29 €
P-43131		100	50			•	•	21,84 €
P-43147		120	50			•	•	21,84 €
P-43153		150	50			•	•	21,84 €
P-43169		180	50			•	•	21,84 €
P-43175		240	50			•	•	21,84 €

## Ďalšie príslušenstvo



objednávacie číslo	popis	ks/bal	BO3700	BO3710, BO3711	BO4900V	9036	9046	cena s DPH
192989-7	dierovacia doska	1	•	•				5,30 €
192523-3		1			•		•	27,40 €
194930-6	základná doska – suchý zips	1	•	•				15,21 €
193521-0		1			•		•	26,60 €
122442-9	základná doska	1				•		37,93 €
140441-9		1		•				2,57 €
162172-0		1					•	24,07 €
193294-5	papierové vrecko vrátane držiaču	1	•	•	•		•	12,59 €
135246-0		1	•					4,71 €
135246-0		1		•				4,71 €
• 194746-9	papierové vrecko / balenie pre držiak 135237-0 a 135246-0	5	•					4,96 €
•• 193293-7	papierové vrecko / balenie pre držiak 193294-5	5	•	•	•		•	6,97 €
••• 168557-8	papierové vrecko / balenie pre držiak 135237-0 a 135246-0	1		•				2,18 €

\*len k nádobe 135246-0 \*\*len k držiaču 193294-5 \*\*\*len k nádobe 135237-0



# Excentrické brúsky

## Brúsny papier na suchý zips 125 mm, 8 otvorov

Vhodné pre farebné kovy, plasty, drevo, drevo s klincami, kov, kameň.

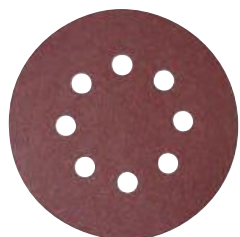

objednávacie číslo	popis	zrornosť	ks/bal	BO5010, BO5012, BO5030, BO5031	BO5020, BO5021, BO5041	BO6030	BO6040	cena s DPH
P-43533	brúsny papier	40	10	•	•			4,11 €
P-43549		60	10	•	•			3,95 €
P-43555		80	10	•	•			3,72 €
P-43561		100	10	•	•			3,66 €
P-43577		120	10	•	•			3,66 €
P-43583		180	10	•	•			3,66 €
P-43599		240	10	•	•			3,66 €
P-43608		320	10	•	•			3,66 €
P-43614		400	10	•	•			3,66 €
P-43620		40	50	•	•			18,25 €
P-43636		60	50	•	•			17,40 €
P-43642		80	50	•	•			16,16 €
P-43658		100	50	•	•			15,83 €
P-43664		120	50	•	•			15,83 €
P-43670		180	50	•	•			15,83 €
P-43686		240	50	•	•			15,83 €
P-43692		320	50	•	•			15,83 €
P-43701		400	50	•	•			15,83 €

## Brúsny papier na suchý zips 125 mm, 8 otvorov

Vhodné pre farebné kovy, plasty, drevo, drevo s klincami, kov, kameň.

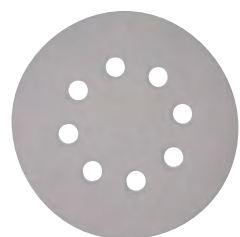

objednávacie číslo	popis	zrornosť	ks/bal	BO5010, BO5012, BO5030, BO5031	BO5020, BO5021, BO5041	BO6030	BO6040	cena s DPH
P-33342	brúsny papier	40	10	•	•			3,69 €
P-33358		60	10	•	•			3,53 €
P-33364		80	10	•	•			3,33 €
P-33370		100	10	•	•			3,23 €
P-33386		120	10	•	•			3,23 €
P-33392		180	10	•	•			3,23 €
P-33401		240	10	•	•			3,23 €
P-33417		320	10	•	•			3,23 €
P-33423		400	10	•	•			3,23 €
P-37384		40	50	•	•			16,03 €
P-37390		60	50	•	•			15,28 €
P-37409		80	50	•	•			14,17 €
P-37415		100	50	•	•			13,71 €
P-37421		120	50	•	•			13,71 €
P-37437		180	50	•	•			13,71 €
P-37443		240	50	•	•			13,71 €
P-37459		320	50	•	•			13,71 €
P-37465		400	50	•	•			13,71 €



# Excentrické brúsky

## Brúsny papier na suchý zips 150mm, 6 otvorov

Vhodné pre laky a farby, farebné kovy, plasty, drevo, drevo s klincami, kov, kameň.



objednávacie číslo	popis	zrnitosť	ks/bal	BO5010, BO5012, BO5030, BO5031	BO5020, BO5021, BO5041	BO6030	BO6040	cena s DPH
P-37471	brúsny papier	40	10			•	•	5,81 €
P-37487		60	10			•	•	5,61 €
P-37493		80	10			•	•	5,42 €
P-37502		100	10			•	•	5,06 €
P-37518		120	10			•	•	5,06 €
P-37524		180	10			•	•	5,06 €
P-37530		240	10			•	•	5,06 €
P-37546		320	10			•	•	5,06 €
P-37552		400	10			•	•	5,06 €
P-37568		40	50			•	•	27,06 €
P-37574		60	50			•	•	26,14 €

## Brúsny papier na suchý zips 150mm, 6 otvorov

Vhodné pre laky a farby, farebné kovy, plasty, drevo, drevo s klincami, kov, kameň.



objednávacie číslo	popis	zrnitosť	ks/bal	BO5010, BO5012, BO5030, BO5031	BO5020, BO5021, BO5041	BO6030	BO6040	cena s DPH
P-37580	brúsny papier	80	50			•	•	25,23 €
P-37596		100	50			•	•	23,40 €
P-37605		120	50			•	•	23,40 €
P-37611		180	50			•	•	23,40 €
P-37627		240	50			•	•	23,40 €
P-37633		320	50			•	•	23,40 €
P-37649		400	50			•	•	23,40 €

## Brúsny papier na suchý zips 150mm, 6 otvorov

Vhodné pre laky a farby, farebné kovy, plasty, drevo, drevo s klincami, kov, kameň.



objednávacie číslo	popis	zrnitosť	ks/bal	BO5010, BO5012, BO5030, BO5031	BO5020, BO5021, BO5041	BO6030	BO6040	cena s DPH
P-37655	brúsny papier	40	10			•	•	5,42 €
P-37661		60	10			•	•	5,09 €
P-37677		80	10			•	•	4,90 €
P-37683		100	10			•	•	4,73 €
P-37699		150	10			•	•	4,73 €
P-37708		180	10			•	•	4,73 €
P-37714		240	10			•	•	4,73 €
P-37720		320	10			•	•	4,73 €
P-37736		400	10			•	•	4,73 €
P-37742		40	50			•	•	23,66 €
P-37758		60	50			•	•	21,90 €
P-37764		80	50			•	•	20,99 €
P-37770		100	50			•	•	20,24 €
P-37786		120	50			•	•	20,24 €
P-37792		180	50			•	•	20,24 €
P-37801		240	50			•	•	20,24 €
P-37817		320	50			•	•	20,24 €
P-37823		400	50			•	•	20,24 €



# Excentrické brúsky

## Brúsny papier na suchý zips 150 mm, 8 + 1 otvor

Vhodné pre farebné kovy, plasty, drevo, drevo s klincami, kov, kameň.



objednávacie číslo	popis	zrornosť	ks/bal	BO5010, BO5012, BO5030, BO5031	BO5020, BO5021, BO5041	BO6030	BO6040	cena s DPH
P-31918	brúsny papier	40	10			•	•	5,81 €
P-31924		60	10			•	•	5,61 €
P-31930		80	10			•	•	5,42 €
P-31946		100	10			•	•	5,06 €
P-31952		120	10			•	•	5,06 €
P-31968		150	10			•	•	5,06 €
P-31974		180	10			•	•	5,06 €
P-31980		220	10			•	•	5,06 €
P-31996		240	10			•	•	5,06 €
P-32007		320	10			•	•	5,06 €
P-32013		400	10			•	•	5,06 €
P-32574		40	50			•	•	27,06 €
P-32580		60	50			•	•	26,14 €
P-32596		80	50			•	•	25,23 €
P-32605		100	50			•	•	23,40 €
P-32611		120	50			•	•	23,40 €
P-32655		240	50			•	•	23,40 €
P-32661		320	50			•	•	23,40 €
P-32677		400	50			•	•	23,40 €

## Brúsny papier na suchý zips 150 mm, 8 + 1 otvor

Vhodné pre laky a farby, farebné kovy, plasty, drevo, drevo s klincami, kov, kameň.



objednávacie číslo	popis	zrornosť	ks/bal	BO5010, BO5012, BO5030, BO5031	BO5020, BO5021, BO5041	BO6030	BO6040	cena s DPH
P-37839	brúsny papier	40	10			•	•	5,42 €
P-37845		60	10			•	•	5,09 €
P-37851		80	10			•	•	4,90 €
P-37867		100	10			•	•	4,73 €
P-37873		120	10			•	•	4,73 €
P-37889		150	10			•	•	4,73 €
P-37895		180	10			•	•	4,73 €
P-37904		220	10			•	•	4,73 €
P-37910		240	10			•	•	4,73 €
P-37932		400	10			•	•	4,73 €
P-37960		80	50			•	•	20,99 €
P-37976		100	50			•	•	20,24 €
P-37982		120	50			•	•	20,24 €
P-37998		180	50			•	•	20,24 €
P-38009		240	50			•	•	20,24 €
P-38015		320	50			•	•	20,24 €
P-38021		400	50			•	•	20,24 €



# Príslušenstvo pre BO6050



objednávacie číslo	popis	ø (mm)	cena s DPH
197317-1	brúsny tanier (suchý zips) na leštenie	150	47,29 €
197314-7	brúsny tanier (suchý zips) jemný	150	47,64 €
197315-5	brúsny tanier (suchý zips) tvrdý	150	56,35 €

## Brúsny papier pre DSL800

objednávacie číslo	popis	priemer (mm)	zrnitosť	ks/bal	cena s DPH
B-68389	brúsny papier	225	40	25	31,82 €
B-68395		225	80	25	30,19 €
B-68404		225	120	25	26,11 €
B-68410		225	180	25	26,11 €
B-68426		225	320	25	26,11 €



# Excentrické brúsky

Brúsny papier / rolka



objednávacie číslo	popis	rozmer / m	zrניות	cena s DPH
P-38102	brúsny papier	120 / 5	40	6,20 €
P-38196		120 / 50	40	58,33 €
P-38118		120 / 5	60	4,93 €
P-38205		120 / 50	60	45,14 €
P-38124		120 / 5	80	4,34 €
P-38211		120 / 50	80	39,10 €
P-38130		120 / 5	100	3,95 €
P-38227		120 / 50	100	36,13 €
P-38146		120 / 5	120	3,95 €
P-38233		120 / 50	120	36,13 €
P-38152		120 / 5	180	3,95 €
P-38249		120 / 50	180	36,13 €
P-38168		120 / 5	240	3,95 €
P-38255		120 / 50	240	36,13 €
P-38174		120 / 5	320	3,95 €
P-38261		120 / 50	320	36,13 €
P-38180		120 / 5	400	3,95 €

## Brúsny kameň

objednávacie číslo	popis	rozmer	cena s DPH
794061-7	brúsny kameň	150 × 70 × 20	11,52 €
794060-9		180 × 70 × 20	13,23 €





# Excentrické brúsky

## Príslušenstvo



- len k nádobe 135246-0
- len k držiaku 193294-5



objednávacie číslo	popis	ks/bal	BO5010, BO5012, BO5030, BO5031	BO5020, BO5021, BO5041	BO6030	BO6040	cena s DPH
743081-8		1	•	•			16,51 €
197468-0		1	•	•			12,93 €
A-87806	základná doska základná doska tvrdá základná doska stredná základná doska mäkká	1			•	•	22,74 €
196684-1		1			•	•	47,16 €
196686-7		1			•	•	27,22 €
135246-0	papierové vrečko vrátane držiaku	1	•				4,71 €
193294-5		1		•	•		12,59 €
• 194746-9	papierové vrečko / balenie	5	•	BO5041			4,96 €
•• 193293-7		5		•	•		6,97 €
794560-9	leštiaci návlak	1	BO5012 BO5031	BO5021 BO5041			17,77 €
794619-2		1			•	•	34,03 €
794558-6	tanier pre nanášanie vosku	1	BO5012 BO5031	BO5021 BO5041			19,05 €
794618-4	tanier pre odstraňovanie vosku	1			•	•	15,31 €
P-13839	odsávací adaptér	1	•	•	•	•	7,96 €
125779-3	bočná rukoväť			•			7,43 €
824591-5	prepravný kufrík	1				•	25,61 €
824562-2		1	BO5030 BO5031	BO5041			20,71 €

# Elektrické pilníky

## Príslušenstvo

objednávacie číslo	popis	ks/bal	9032	9031	9910	9911	cena s DPH
125158-5	oporné rameno 9 mm	1	•				33,94 €
125159-3	oporné rameno 13 mm	1	•				82,08 €
193618-5	vodiace sane	1	•				40,13 €
192694-6	skrutkové svorky / pár	2			•	•	48,49 €
342152-4	oceľová doska	1		•			5,61 €
345503-0		1			•	•	5,22 €
122548-3	zberné vrečko na prach	1			•	•	4,90 €
P-13839	odsávací adaptér k vysávaču	1	•	•	•	•	7,96 €





# Elektrické pilníky

## Textilný brúsny pás 6 × 533 mm

Vhodné pre farebné kovy, plasty, drevo, drevo s klincami, kov, kameň.



objednávacie číslo	popis	zrnitosť	ks/bal	9032	9031	9910	9911	cena s DPH
P-43181	Brúsny papier	40	5	•				4,37 €
P-43197		60	5	•				4,31 €
P-43206		80	5	•				4,21 €
P-43212		100	5	•				4,18 €
P-43228		120	5	•				4,18 €
P-43234		150	5	•				4,18 €
P-43240		240	5	•				4,18 €

## Textilný brúsny pás 9 × 533 mm

Vhodné pre farebné kovy, plasty, drevo, drevo s klincami, kov, kameň.



objednávacie číslo	popis	zrnitosť	ks/bal	9032	9031	9910	9911	cena s DPH
P-43256	Brúsny papier	40	5	•				4,99 €
P-43262		60	5	•				4,86 €
P-43278		80	5	•				4,73 €
P-43284		100	5	•				4,70 €
P-43290		120	5	•				4,70 €
P-43309		150	5	•				4,70 €
P-43315		240	5	•				4,70 €
P-43256	Brúsny papier	40	5	•				4,99 €
P-43262		60	5	•				4,86 €
P-43278		80	5	•				4,73 €
P-43284		100	5	•				4,70 €
P-43290		120	5	•				4,70 €
P-43309		150	5	•				4,70 €

## Textilný brúsny pás 13 × 533 mm

Vhodné pre farebné kovy, plasty, drevo, drevo s klincami, kov, kameň.



objednávacie číslo	popis	zrnitosť	ks/bal	9032	9031	9910	9911	cena s DPH
P-43321	Brúsny papier	40	5	•				6,33 €
P-43337		60	5	•				6,14 €
P-43343		80	5	•				5,94 €
P-43359		100	5	•				5,88 €
P-43365		120	5	•				5,88 €
P-43371		150	5	•				5,88 €
P-43387		240	5	•				5,88 €

## Textilný brúsny pás 30 × 533 mm

Vhodné pre farebné kovy, plasty, drevo, drevo s klincami, kov, kameň.



objednávacie číslo	popis	zrnitosť	ks/bal	9032	9031	9910	9911	cena s DPH
P-36675	Brúsny papier	40	5		•			3,95 €
P-36681		60	5		•			3,82 €
P-36697		80	5		•			3,75 €
P-36706		100	5		•			3,62 €
P-36712		120	5		•			3,62 €
P-36728		150	5		•			3,62 €
P-36734		240	5		•			3,62 €



## Elektrické pilníky

### Textilný brúsny pás 30 × 533 mm

Vhodné na sklo – suché brúsenie.



objednávacie číslo	popis	zrornosť	ks/bal	9032	9031	9910	9911	cena s DPH
P-01395	Brúsny papier	40	5		•			10,25 €
P-01404		60	5		•			8,75 €
P-01199		80	5		•			8,58 €
P-01208		100	5		•			8,23 €
P-01214		120	5		•			7,31 €
P-01220		150	5		•			7,31 €
P-01236		240	5		•			7,31 €

## Pásové brúsky

### Textilný brúsny pás 76 × 457 mm

Vhodné na sklo – suché brúsenie



objednávacie číslo	popis	zrornosť	ks/bal	9032	9031	9910	9911	cena s DPH
P-37091	Brúsny papier	40	5			•	•	8,23 €
P-37100		60	5			•	•	8,00 €
P-37116		80	5			•	•	7,90 €
P-37122		100	5			•	•	7,83 €
P-37138		120	5			•	•	7,83 €
P-37144		150	5			•	•	7,83 €
P-37150		240	5			•	•	7,83 €
P-37166		40, 80, 120	3			•	•	4,80 €

### Textilný brúsny pás 76 × 533 mm

Vhodné pre farebné kovy, plasty, drevo, drevo s klincami, kov, kameň.



objednávacie číslo	popis	zrornosť	ks/bal	9903	9920	9924DB	9402	9403	9404	cena s DPH
P-37172	Brúsny papier	40	5	•						8,94 €
P-37188		60	5	•						8,42 €
P-37194		80	5	•						7,93 €
P-37203		100	5	•						7,77 €
P-37219		120	5	•						7,77 €
P-37225		150	5	•						7,77 €
P-37231		240	5	•						7,77 €
P-37247		40	25	•						38,48 €
P-37253		60	25	•						36,75 €
P-37269		80	25	•						33,23 €
P-37275		100	25	•						32,61 €
P-37281		120	25	•						32,61 €
P-37297		150	25	•						32,61 €
P-37306		240	25	•						32,61 €
P-43393		40	50	•						71,35 €
P-43402		60	50	•						68,71 €
P-43418		80	50	•						65,74 €
P-43424		100	50	•						65,21 €
P-43430		120	50	•						65,21 €
P-43446		150	50	•						65,21 €
P-43452		240	50	•						65,21 €



# Pásové brúsky

## Textilný brúsny pás 76 × 610mm

Vhodné pre farebné kovy, plasty, drevo, drevo s klincami, kov, kameň.



objednávacie číslo	popis	zrnitosť	ks/bal	9903	9920	9924DB	9402	9403	9404	cena s DPH
P-37312	Brúsny papier	40	40	5		•	•			9,66 €
P-37328		60	60	5		•	•			9,27 €
P-37334		80	80	5		•	•			8,52 €
P-37340		100	100	5		•	•			8,29 €
P-37356		120	120	5		•	•			8,29 €
P-37362		150	150	5		•	•			8,29 €
P-37378		240	240	5		•	•			8,29 €
P-51144		40	40	25		•	•			44,86 €
P-51150		60	60	25		•	•			42,48 €
P-51164		80	80	25		•	•			42,26 €
P-51172		100	100	25		•	•			37,38 €
P-51188		120	120	25		•	•			36,97 €
P-51194		150	150	25		•	•			37,18 €
P-51203		240	240	25		•	•			37,18 €

## Textilný brúsny pás 100 × 610mm

Vhodné pre farebné kovy, plasty, drevo, drevo s klincami, kov, kameň.



objednávacie číslo	popis	zrnitosť	ks/bal	9903	9920	9924DB	9402	9403	9404	cena s DPH
P-36887	Brúsny papier	40	5			•	•	•	•	11,10 €
P-36893		60	5			•	•	•	•	10,64 €
P-36902		80	5			•	•	•	•	10,44 €
P-36918		100	5			•	•	•	•	10,15 €
P-36924		120	5			•	•	•	•	10,15 €
P-36930		150	5			•	•	•	•	10,15 €
P-36946		240	5			•	•	•	•	10,15 €
P-36952		40	25			•	•	•	•	46,90 €
P-36968		60	25			•	•	•	•	44,72 €
P-36974		80	25			•	•	•	•	43,77 €
P-36980		100	25			•	•	•	•	43,35 €
P-36996		120	25			•	•	•	•	43,35 €
P-37007		150	25			•	•	•	•	43,35 €
P-37013		240	25			•	•	•	•	43,35 €
P-43468		40	50			•	•	•	•	93,81 €
P-43474		60	50			•	•	•	•	89,40 €
P-43480		80	50			•	•	•	•	87,54 €
P-43496		100	50			•	•	•	•	86,66 €
P-43505		120	50			•	•	•	•	86,66 €
P-43511		150	50			•	•	•	•	86,66 €
P-43527		240	50			•	•	•	•	86,66 €



# Pásové brúsky

## Textilný brúsny pás 100 × 620 mm

Vhodné pre farebné kovy, plasty, drevo, drevo s klincami, kov, kameň.



objednávacie číslo	popis	zrornosť	ks/bal	9903	9920	9924DB	9402	9403	9404	cena s DPH
P-37029	Brúsny papier	40	5			•				11,33 €
P-37035		60	5			•				10,84 €
P-37041		80	5			•				10,64 €
P-37057		100	5			•				10,35 €
P-37063		120	5			•				10,35 €
P-37079		150	5			•				10,35 €
P-37085		240	5			•				10,35 €

## Textilný brúsny pás 100 × 560 mm

Vhodné pre farebné kovy, plasty, drevo, drevo s klincami, kov, kameň.



objednávacie číslo	popis	zrornosť	ks/bal	9903	9920	9924DB	9402	9403	9404	cena s DPH
P-36740	Brúsny papier	40	5	•	•	•	•	•	•	10,41 €
P-36756		60	5	•	•	•	•	•	•	10,05 €
P-36762		80	5	•	•	•	•	•	•	9,92 €
P-36778		100	5	•	•	•	•	•	•	9,76 €
P-36784		120	5	•	•	•	•	•	•	9,76 €
P-36790		150	5	•	•	•	•	•	•	9,76 €
P-36809		240	5	•	•	•	•	•	•	9,76 €
P-36815		40	25	•	•	•	•	•	•	41,78 €
P-36821	60	25	•	•	•	•	•	•	40,47 €	
P-36837	80	25	•	•	•	•	•	•	39,76 €	
P-36843	100	25	•	•	•	•	•	•	39,36 €	
P-36859	120	25	•	•	•	•	•	•	39,36 €	
P-36865	150	25	•	•	•	•	•	•	39,36 €	
P-36871	240	25	•	•	•	•	•	•	39,36 €	



# Pásové brúsky

## Príslušenstvo



objednávacie číslo	popis	ks/bal	9903	9920	9924DB	9402	9403	9404	9910/9911	9901	cena s DPH	
193055-3	stojan na pásovú brúsku	1	•	•				•			102,46 €	
122353-8										•	60,31 €	
342332-2	držiak	1				•					2,99 €	
193071-5	brúsny rám	1		•							95,84 €	
193072-3		1						•			98,88 €	
193070-7		1	•								83,33 €	
• 151749-6			1	•								4,51 €
• 150980-1	oceľová doska • oceľová doska vrátane korku	1						•			5,68 €	
• 151750-1		1		•							5,10 €	
• 151751-9		1							•		5,75 €	
341705-6		1			•						2,42 €	
342328-3		1				•					2,37 €	
423312-8	korková doska • korková doska pre 150980-1	1	•								1,72 €	
423313-6		1		•							2,25 €	
423035-8		1			•						2,48 €	
423314-4		1							•		2,91 €	
• 421646-3		1							•		2,55 €	
421093-8		1					•	•			2,63 €	
423315-2		1	•								3,06 €	
423036-6		1			•						2,83 €	
423316-0		grafitová doska	1		•							3,61 €
423317-8			1						•			5,17 €
421648-9	1							•			3,94 €	
A-86262		1				•					3,74 €	
122591-2	lapač prachu	1	•	•				•			17,11 €	
122296-4		1			•						18,60 €	
122297-2		1				•					12,56 €	
122562-9		1						•			17,38 €	
192613-2	adaptér na odsávanie	1	•	•		•	•	•			19,04 €	
192518-6		1			•						15,72 €	
192694-6	svorky / pár								•		48,49 €	





# Priame brúsky / brúsky na betón

## Príslušenstvo

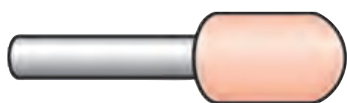
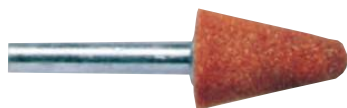

objednávacie číslo	tvar	ø stopky (mm)	ø telieska (mm)	ks/bal	cena s DPH
794050-2		3	5	10	20,92 €
794052-8	kúžeľovitý	3	8	10	18,60 €
794053-6		3	10	10	18,59 €
794054-4		3	5	10	28,22 €
794055-2	polguľatý	3	6	10	24,23 €
794057-8		3	10	10	25,39 €
794059-4	guľatý	3	10	10	29,76 €



objednávacie číslo	popis	ø stopky (mm)	ks/bal	906	GD0600 GD0601	GD0602	DGD800	GD0800C GD0810C	GD0801C GD0811C	cena s DPH
763627-4		3	1	•	•					12,19 €
763669-8		3	1			•	•			18,21 €
763620-8	upínacia klieština	6	1	•	•					8,21 €
763670-3		6	1			•	•			9,63 €
763671-1		8	1			•	•			17,16 €
763240-8			1	•						2,97 €
763664-8	upínacia matica		1		•					1,45 €
763668-0			1			•	•			1,33 €
193011-3		3	1					•	•	26,22 €
193012-1	upínacia klieština s maticou	6	1					•	•	21,54 €
192988-9		8	1					•	•	26,78 €



# Priame brúsky / brúsky na betón

Príslušenstvo k PC1100



objednávacie číslo	popis	cena s DPH
192613-2	adaptér na odsávanie	19,04 €
122193-4	vak na prach	17,85 €
181789-0	oceľový kufrík	79,87 €
782401-1	kolíkový kľúč 20	1,13 €

## Príslušenstvo

### Diamantový kotúč z nízkymi vibráciami

#### Nízke vibrácie

Technológia kotúča vstrebáva vibrácie pri brúsení, tým sú vibrácie prenášané na obsluhu menšie.

#### Menej otrasov

Lepšia priľnavosť k materiálu zabezpečí rýchlejšie a efektívnejšie brúsenie.

<porovnanie povrchu, brúsenie po 30 sekundách>



typ z nízkymi vibráciami

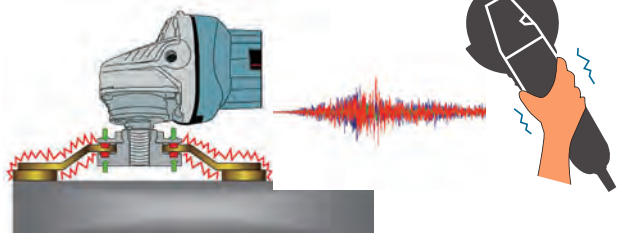

typ z nízkymi vibráciami



bežný kotúč

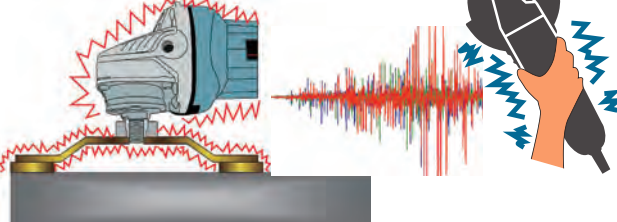

bežný kotúč

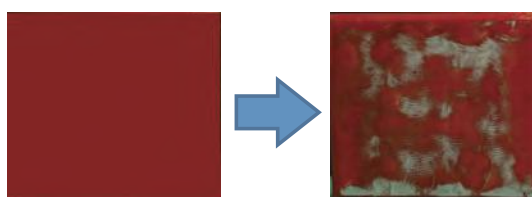



## Brúsne diamantové kotúče



objednávacie číslo	popis	cena s DPH
B-48533	kotúč diamantový 125 mm x M14	107,97 €
B-48549	kotúč diamantový 125 mm x M14	108,85 €
B-48555	kotúč diamantový 125 mm x M14	117,91 €



## Brúsne diamantové kotúče



objednávacie číslo	popis	cena s DPH
B-48561	kotúč diamantový 125 mm x 22.23MM	87,17 €
B-48577	kotúč diamantový 125 mm x 22.23MM	92,05 €
B-48583	kotúč diamantový 125 mm x 22.23 MM	98,87 €



# Priame brúsky / brúsky na betón

Príslušenstvo k PW5000CH



objednávacie číslo	popis	ø kotúča (mm)	zrnitosť	farba	cena s DPH
D-15584		100	50	modrá	13,51 €
D-15590		100	100	žltá	14,65 €
D-15609		100	200	oranžová	14,17 €
D-15615	diamantový kotúč	100	400	červená	10,90 €
D-15621		100	800	tmavozelená	11,89 €
D-15637		100	1500	svetlozelená	17,67 €
D-15643		100	3000	hnedá	14,48 €
D-15805	diamantové kotúče – sada 8 ks	100	50	modrá	133,29 €
		100	100	žltá	
		100	200	oranžová	
		100	400	červená	
		100	800	tmavozelená	
		100	1500	svetlozelená	
		100	3000	hnedá	
D-15659	diamantový pryžový kotúč	100		zelená	22,29 €
743080-0	brúsny kotúč	100			32,64 €
P-67016	oddelovací adaptér				775,95 €



# Brúsky a leštičky

## Brúsny papier 180 mm, neperforovaný k brúsnemu kotúču 743053-3

Vhodné pre farebné kovy, plasty, drevo, drevo s klincami, kov, kameň.

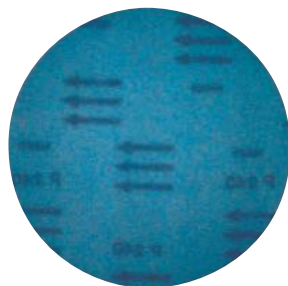

objednávacie číslo	popis	zrornosť	ks/bal	PV7000C	9207SPB	9227CB	9227CB	cena s DPH
P-33445		80	10	•	•	•	•	8,26 €
P-33451		120	10	•	•	•	•	7,44 €
P-38059		240	10	•	•	•	•	7,34 €
P-38065		320	10	•	•	•	•	7,34 €
P-38071		360	10	•	•	•	•	7,34 €
P-38087		400	10	•	•	•	•	7,34 €
P-38093		500	10	•	•	•	•	7,34 €

## Fibrové kotúče

Fibrové kotúče 180 mm k brúsnym kotúčom 743012-7 a P-05913.

Vhodné pre farebné kovy, plasty, drevo, drevo s klincami, kov, kameň.



objednávacie číslo	popis	zrornosť	ks/bal	PV7000C	9207SPB	9227CB	SA7000C	cena s DPH
P-01024		16	5		•		•	7,70 €
P-01030		24	5		•		•	6,63 €
P-01046		36	5		•		•	6,63 €
P-01052		40	5		•		•	6,63 €
P-01068	brúsny papier	50	5		•		•	6,63 €
P-01074		60	5		•		•	6,63 €
P-01080		80	5		•		•	6,63 €
P-01096		100	5		•		•	6,63 €
P-01105		120	5		•		•	6,63 €



# Brúsky a leštičky

Príslušenstvo k priamym brúskam a leštičkám



objednávacie číslo	popis	priemer (mm)	ks/bal	PV7000C	9207SPB	9227CB	SA7000C	cena s DPH
P-04488	oceľová drôtená hrncová kefa 18 vrkočov	65	1	•	•	•	•	11,70 €
743053-3	brúsny tanier – suchý zips	165	1	•	•	•	•	19,98 €
192629-7	leštiaci nástavec k 743053-3	180	1	•	•	•	•	18,12 €
P-05913	brúsny tanier s prírubou	180	1	•	•	•	•	7,56 €
794176-0	nástavec na leštenie k 743012-7 a P-05913	180	1	•	•	•	•	23,34 €
743053-3	kotúč so suchým zipsom pre hubky	165	1	•	•	•	•	19,98 €



objednávacie číslo	popis	ks/bal	cena s DPH
D-56960	adaptér pre leštiaci kotúč D-56954	1	1,34 €
D-56954	leštiaci kotúč 230 x 75 mm	1	28,72 €

Príslušenstvo pre BO6040/6030



objednávacie číslo	popis	priemer (mm)	ks/bal	cena s DPH
794619-2	leštiaci kotúč	150	1	34,03 €
794618-4	leštiaci kotúč	150	1	15,31 €





# Brúsky a leštičky

## Leštiace hubky a kotúče



objednávacie číslo	popis	priemer (mm)	ks/bal	9565CVL	PV7000C	9227CB	SA7000C	cena s DPH
P-21777	kotúč so suchým zipsom pre hubky	120	1	•	•	•	•	10,09 €
P-21727	hustá hubka na dvojvrstvové farebné nátery	150	1	•	•	•	•	12,57 €
P-21733	mäkká hubka na celulózu, akryláty atď.	150	1	•	•	•	•	10,51 €
P-21749	pevná hubka na leštenie	150	1	•	•	•	•	8,58 €
P-21761	kotúče na uchytanie „baránka“	170	1		•	•	•	28,34 €

# Dvojkotúčové brúsky

## Brúsne kotúče k dvojkotúčovým brúskam



objednávacie číslo	typ/zrznosť	použitie	rozmer	cena s DPH
B-51904	A36M	železo	150 × 16 × 12,7	14,61 €
B-51910	A60M	železo	150 × 16 × 12,7	12,14 €
B-51932	GC120H	tenké plechy Cu,Ni,Ms,Zn	150 × 16 × 12,7	17,54 €
B-51895	A60M	železo	150 × 6,4 × 12,7	13,35 €
B-51926	WA60K	Železo/nerez	150 × 16 × 12,7	14,70 €
B-51948	A36P	železo	205 × 19 × 15,88	19,39 €
B-51954	A60P	železo	205 × 19 × 15,88	20,98 €
B-51976	GC120H	tenké plechy Cu,Ni,Ms,Zn	205 × 19 × 15,88	25,81 €
B-51960	WA60K	železo/nerez	205 × 19 × 15,88	22,13 €



# Kefové brúsky

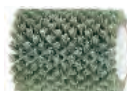

objednávacie číslo	popis	zrornosť	cena s DPH
P-01127	lamelová brúsna kefa na brúsenie povrchov, odstraňovanie farieb a pod.	40	65,52 €
P-65648	kefa z oceľového drôtu, potiahnutá mosadzou, 0,5mm pre vysoký uber vhodná na štruktúrovanie dreva, na odrezávanie a čistenie		109,55 €
794382-7	drôtená kefa na leštenie železných plôch	120	149,07 €
P-04400	kefa z oceľového drôtu 0,5mm na odstraňovanie rezu a farieb, na čistenie betónového debnenia		115,19 €
P-04416	fibrová kefa na zapracovanie moridiel a lakov + na následné vyhladenie		91,20 €
79438 1-9	bavlnená leštiaca kefa na leštenie povrchových plôch aj s pridaním zodpovedajúcich leštiacich pást		218,71 €
P-04422		60	108,51 €
P-04438	brúsna nylonová kefa na štruktúrovanie mäkkého dreva a na dopracovávanie štruktúrovaní starého dreva. pre zvýraznenie štruktúry dreva a na odstraňovanie existujúcich drevených vlákien.	80	107,98 €
P-04444	pre optimálnu prípravu plôch na lakovanie a morenie.	120	108,17 €
P-04450	pre zhotovenie brúsneho obrazu na ušľachtilej oceli a hliníku.	180	110,27 €
794384-3		80	189,18 €
P-18035		80	60,09 €
P-18041	valcová kefa vlies na jemné štruktúrovanie ušľachtilej ocele a jemné brúsenie povrchových plôch dreva	120	60,78 €
P-18029		180	58,54 €
P-18057		80	65,66 €
P-19233	valcová kombinovaná kefa leinen/vlies na jemné štruktúrovanie ušľachtilej ocele a jemné brúsenie povrchových plôch dreva	120	67,34 €
P-19249		180	69,25 €
410899-9	nástavec na odsávanie		1,25 €



# Sponkovačky

## Spony pre AT638

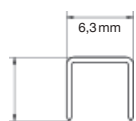

objednávacie číslo	typ	šírka (mm)	dĺžka (mm)	ks/bal	vhodné pre stroj	cena s DPH
F-32557	spony	6,3	16	5000	AT638	10,28 €
F-32560	spony	6,3	19	5000	AT638	10,44 €
F-32573	spony	6,3	22	5000	AT638	12,01 €
F-33607	spony	6,3	25	5000	AT638	16,87 €
F-33610	spony	6,3	28	5000	AT638	25,36 €
F-33623	spony	6,3	30	5000	AT638	24,45 €
F-33636	spony	6,3	32	5000	AT638	19,28 €
F-33649	spony	6,3	38	5000	AT638	24,20 €

## Spony pre AT1150A

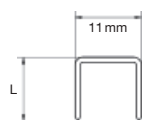

objednávacie číslo	typ	šírka (mm)	dĺžka (mm)	ks/bal	vhodné pre stroj	cena s DPH
F-32078	spony	11	25	10000	AT1150A	50,94 €
F-32081	spony	11	28	10000	AT1150A	65,60 €
F-32094	spony	11	32	10000	AT1150A	59,67 €
F-32100	spony	11	35	10000	AT1150A	75,17 €
F-32113	spony	11	40	10000	AT1150A	88,07 €
F-32126	spony	11	45	10000	AT1150A	101,94 €
F-32139	spony	11	51	10000	AT1150A	87,84 €

## Spony pre AT2550A

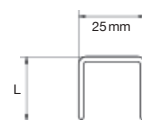

objednávacie číslo	typ	šírka (mm)	dĺžka (mm)	ks/bal	vhodné pre stroj	cena s DPH
F-32023	spony	25	25	10000	AT2550A	60,28 €
F-32036	spony	25	32	10000	AT2550A	101,93 €
F-32049	spony	25	38	10000	AT2550A	86,89 €
F-32052	spony	25	45	10000	AT2550A	111,22 €
F-32065	spony	25	51	10000	AT2550A	109,21 €



# Sponkovačky

Spony pre T221/BST/DST112/DST220BST/DST221

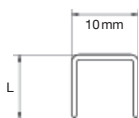

objednávacie číslo	rozmer (mm)	ks/bal	cena s DPH
F-32917	10 × 8	5000	9,63 €
F-32647	10 × 10	5000	11,52 €
F-32650	10 × 13	5000	12,32 €
F-32663	10 × 16	5000	14,88 €
F-32676	10 × 19	5000	15,05 €
F-32689	10 × 22	5000	18,56 €

Spony pre BST/DST110/ST113

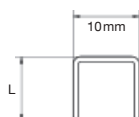

objednávacie číslo	rozmer (mm)	ks/bal	cena s DPH
F-81518	10 × 7	2500	1,25 €
F-81521	10 × 10	2500	4,36 €

Ďalšie príslušenstvo ku sponkovačkám/klincovačkám



objednávacie číslo	typ	rozmer	ks/bal	vhodné pre stroj	cena s DPH
243105-5	vsuvka			(všetky vysokotlaké stroje)	11,08 €
960016	vsuvka	5/8"		AN943	2,94 €
HY00000080	vsuvka	1/2"		AN902, AN901, AN621, AT1150, AT2250, AT638, AF201Z, AF505	1,18 €
P-45989	kompresorová vsuvka	1/4"	1	AT638, AT1150A, AT2550A	8,73 €
P-45973	vzduchová hadica 15 m	ø 8 mm	1	AT1150A, AT2550A	57,46 €
181434-7	olejová nádoba 30 cc		1	AT638, AT1150A, AT2550A	1,08 €





# Klincovačky

## Príslušenstvo

objednávacie číslo	typ	rozmer	ks/bal	vhodné pre stroj	cena s DPH
 P-45989	kompresorová vsuvka	1/4"	1	AN621, AN911, AN510H, AN510H, AN610H, AN620H, AN711H, AN911H	8,73 €
243104-7		3/8"	1	AN943	4,80 €
P-45973	vzduchová hadica 15 m	Ø 8 mm	1	AF201Z, AN621, AN911, AN943	57,46 €
 B-80036	vysokotlaková vzduchová hadica 7,5 m		1	AN450H, AN610H, AN620H, AN711H, AN911H	193,77 €
B-80014	vysokotlaková vzduchová hadica 15 m		1	AN450H, AN610H, AN620H, AN711H, AN911H	226,34 €
B-80020	vysokotlaková vzduchová hadica 30 m		1	AN450H, AN610H, AN620H, AN711H, AN911H	309,92 €
B-80008	navijak na vysokotlakové vzduchové hadice		1	AN450H, AN610H, AN620H, AN711H, AN911H	577,44 €
 181434-7	olejová nádoba 30 cc		1	AF201Z, AN621, AN911, AN510H, AN510H, AN610H, AN620H, AN711H, AN911H	1,08 €
421996-6	adaptér ústia klincovačky adaptér ústia klincovačky – dosky		1	AN510H	0,71 €
421997-4	adaptér ústia klincovačky – podlahy		1	AN510H	0,98 €
 960016	adaptér rýchlospojky		1	AN943	2,94 €

## Klince do betónu pre AN250HC

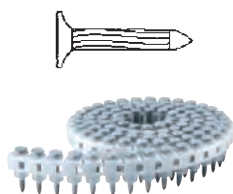

objednávacie číslo	typ	šírka (mm)	dĺžka (mm)	ks/bal	Vhodné pre stroj	cena s DPH
F-33591	klince do betónu	3	19	1000	AN250HC	90,30 €
F-33575	klince do betónu	2,5	22	1000	AN250HC	56,99 €
F-33588	klince do betónu	2,5	25	1000	AN250HC	60,16 €

## Klince pre AN450H (klince páskované pod 16° uhlom)

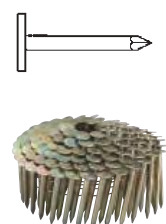

objednávacie číslo	typ	typ drieku	šírka (mm)	dĺžka (mm)	ks/bal	Vhodné pre stroj	cena s DPH
F-37737	klince spájané drôtom	hladký	3,1	19	7200	AN450H	62,18 €
F-30762	klince spájané drôtom	hladký	3,1	22	7200	AN450H	64,95 €
F-30775	klince spájané drôtom	hladký	3,1	25	7200	AN450H	71,08 €
F-30788	klince spájané drôtom	hladký	3,1	32	7200	AN450H	84,59 €
F-30791	klince spájané drôtom	hladký	3,1	38	7200	AN450H	100,17 €
F-30807	klince spájané drôtom	hladký	3,1	45	7200	AN450H	75,46 €



# Klincovačky

Klince pre AN621, AN901, AN902, AN610H, AN620H, AN711H, AN911H, AN960, AN961

(klince s hladkým driekom páskované pod 16° uhlom)



objednávacie číslo	typ	typ drieku	priemer (mm)	dĺžka (mm)	ks/bal	vhodné pre stroj	cena s DPH
F-30810	klince spájané drôtom	hladký	2,5	45	10800	AN621, AN901, AN902, AN911, AN510H, AN610H, AN620H, AN711H, AN911H	65,42 €
F-31243	klince spájané drôtom	hladký	2,5	50	10800	AN621, AN901, AN902, AN911, AN510H, AN610H, AN620H, AN711H, AN911H	125,91 €
F-30823	klince spájané drôtom	hladký	2,8	50	9000	AN621, AN901, AN902, AN911, AN510H, AN610H, AN620H, AN711H, AN911H	91,82 €
F-30849	klince spájané drôtom	hladký	2,9	50	9000	AN621, AN901, AN902, AN911, AN510H, AN610H, AN620H, AN711H, AN911H	135,38 €
F-31256	klince spájané drôtom	hladký	2,5	57	8100	AN621, AN901, AN902, AN911, AN610H, AN620H, AN711H, AN911H	102,12 €
F-30900	klince spájané drôtom	hladký	2,5	65	8100	AN621, AN901, AN902, AN911, AN610H, AN620H, AN711H, AN911H	64,65 €
F-30836	klince spájané drôtom	hladký	3,1	65	6750	AN621, AN901, AN902, AN911, AN620H, AN711H, AN911H	99,26 €
F-30852	klince spájané drôtom	hladký	3,3	65	4050	AN621, AN901, AN902, AN911, AN620H, AN711H, AN911H	82,61 €
F-31359	klince spájané drôtom	hladký	3,4	75	3600	AN911, AN901, AN902, AN711H, AN911H	50,43 €
F-31304	klince spájané drôtom	hladký	3,1	85	4050	AN911, AN901, AN902, AN911H	110,51 €
F-31317	klince spájané drôtom	hladký	3,1	90	4050	AN911, AN901, AN902, AN911H	71,24 €
F-31362	klince spájané drôtom	hladký	3,8	90	2700	AN911, AN901, AN902, AN911H	117,21 €



# Klincovačky

## Klince pre AF201Z, BPT/DPT350, BPT/DPT351, DPT353, PT354

(klince bez hlavičky – pinky)

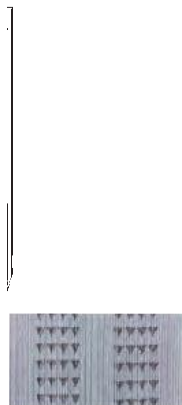

objednávacie číslo	typ	typ drieku	priemer (mm)	dĺžka (mm)	ks/bal	vhodné pre stroj	cena s DPH
F-31825	klince – pinky	hladký	0,6	18	10000	AF201Z, DPT350, DPT351	11,58 €
F-32142	klince pozink	hladký	0,6	18	10000	AF201Z, DPT350, DPT351	26,62 €
F-31838	klince – pinky	hladký	0,6	25	10000	AF201Z, DPT350, DPT351	14,61 €
F-32155	klince pozink	hladký	0,6	25	10000	AF201Z, DPT350, DPT351	29,78 €
F-31841	klince – pinky	hladký	0,6	30	10000	DPT350, DPT351	15,65 €
F-32168	klince pozink	hladký	0,6	30	10000	AF201Z, DPT350, DPT351	30,78 €
F-31854	klince – pinky	hladký	0,6	35	10000	DPT350, DPT351	19,55 €
F-32171	klince pozink	hladký	0,6	35	10000	AF201Z, DPT350, DPT351	35,08 €

## Klince pre AN621, AN901, AN902, AN610H, AN620H, AN711H, AN911H, AN960, AN961

(klince so skrutkovitým driekom páskované pod 16° uhlom)



objednávacie číslo	typ	typ drieku	priemer (mm)	dĺžka (mm)	ks/bal	vhodné pre stroj	cena s DPH
F-30971	klince spájané drôtom	skrutkovitý	2,9	50	9000	AN621, AN901, AN902, AN911, AN620H, AN711H, AN911H	143,66 €
F-30878	klince spájané drôtom	skrutkovitý	2,5	57	8100	AN621, AN901, AN902, AN911, AN610H, AN620H, AN711H, AN911H	109,38 €
F-31272	klince spájané drôtom	skrutkovitý	2,9	57	6750	AN621, AN901, AN902, AN911, AN620H, AN711H, AN911H	121,73 €
F-31269	klince spájané drôtom	skrutkovitý	2,5	65	8100	AN621, AN901, AN902, AN911, AN610H, AN620H, AN711H, AN911H	123,63 €
F-30881	klince spájané drôtom	skrutkovitý	2,9	65	6750	AN621, AN901, AN902, AN911, AN620H, AN711H, AN911H	114,50 €
F-31285	klince spájané drôtom	skrutkovitý	2,9	73	6750	AN911, AN901, AN902, AN711H, AN911H	149,01 €
F-31320	klince spájané drôtom	skrutkovitý	3,2	75	4050	AN911, AN901, AN902, AN711H, AN911H	103,41 €
F-31333	klince spájané drôtom	skrutkovitý	3,1	85	4050	AN911, AN901, AN902, AN911H	121,73 €
F-31346	klince spájané drôtom	skrutkovitý	3,2	90	4050	AN911, AN901, AN902, AN911H	110,58 €





# Klincovačky

## Klince pre AN510H, AN610H, AN560

(klince s hladkým driekom páskované pod 16° uhlom)



objednávacie číslo	typ	typ drieku	priemer (mm)	dĺžka (mm)	ks/bal	vhodné pre stroj	cena s DPH
F-32766	klince spájané drôtom	hladký	2,1	32	21600	AN510H, AN610H	96,25 €
F-32779	klince spájané drôtom	hladký	2,1	38	18000	AN510H, AN610H	138,23 €
F-32782*	klince spájané drôtom	hladký	2,1	45	18000	AN510H, AN610H	76,61 €

\* vhodné pre modely AN901, AN902



## Klince pre AN610H

(klince so skrutkovitým driekom páskované pod 16° uhlom)



objednávacie číslo	typ	typ drieku	priemer (mm)	dĺžka (mm)	ks/bal	vhodné pre stroj	cena s DPH
F-32814	klince spájané drôtom	skrutkovitý	2,1	45	18000	AN610H, AN901, AN902	104,74 €
F-32827	klince spájané drôtom	skrutkovitý	2,1	50	14400	AN610H, AN901, AN902	84,11 €



## Klince pre AN943

(klince D s hladkým driekom, páskované papierom pod 34° uhlom)



objednávacie číslo	typ	typ drieku	priemer (mm)	dĺžka (mm)	ks/bal	vhodné pre stroj	cena s DPH
F-30566	klince D, páskované papierom	hladký	2,9	60	3000	AN943	58,26 €
F-30582	klince D, páskované papierom, galvanizované	hladký	3,1	75	3000	AN943	130,57 €
F-30614	klince D, páskované papierom	hladký	3,3	75	3000	AN943	71,74 €
F-30627	klince D, páskované papierom, galvanizované	hladký	3,3	75	3000	AN943	123,76 €
F-30601	klince D, páskované papierom	hladký	3,1	83	3000	AN943	63,65 €
F-30630	klince D, páskované papierom	hladký	3,3	83	3000	AN943	93,74 €
F-30643	klince D, páskované papierom, galvanizované	hladký	3,3	83	3000	AN943	101,76 €
F-30656	klince D, páskované papierom	hladký	3,3	90	3000	AN943	94,60 €
F-31645	klince D, páskované papierom, galvanizované	hladký	3,3	90	3000	AN943	103,92 €





# Klincovačky

## Klince pre AF505 / DBN500

(kolárske klince)

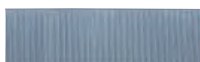

objednávacie číslo	typ	typ drieku	dĺžka (mm)	ks/bal	vhodné pre stroj	cena s DPH
P-45923	kolárske klince	hladký	20	5000	AF505	9,62 €
P-45939	kolárske klince	hladký	25	5000	AF505	10,99 €
P-45945	kolárske klince	hladký	30	5000	AF505	12,56 €
P-45951	kolárske klince	hladký	40	5000	AF505	14,92 €
P-45967	kolárske klince	hladký	50	5000	AF505	17,47 €

## Klince pre AF505/AF505N/DBN500 (Kolárske klince)

objednávacie číslo	typ	typ drieku	dĺžka (mm)	ks/bal	vhodné pre stroj	cena s DPH
F-31867	kolárske klince	hladký	15	5000	AF505/AF505N	8,65 €
F-31870	kolárske klince	hladký	20	5000	AF505/AF505N	12,24 €
F-31883	kolárske klince	hladký	25	5000	AF505/AF505N	13,80 €
F-31896	kolárske klince	hladký	30	5000	AF505/AF505N	15,22 €
F-31915	kolárske klince	hladký	35	5000	AF505/AF505N	18,88 €
F-31928	kolárske klince	hladký	38	5000	AF505/AF505N	19,10 €
F-31931	kolárske klince	hladký	40	5000	AF505/AF505N	20,37 €
F-31944	kolárske klince	hladký	45	5000	AF505/AF505N	22,64 €
F-31957	kolárske klince	hladký	50	5000	AF505/AF505N	25,45 €

## Pneumatické náradie



objednávacie číslo	popis	veľkosť	ks/bal	cena s DPH
P-51487	klinec AN621	2,5 × 45 mm	9000	90,44 €
P-51502	klinec AN621	2,5 × 64 mm	9000	108,10 €
P-51493	klinec AN621, AN901/AN902	2,5 × 50 mm	5000	95,03 €
P-51524	klinec AN901/AN902	2,8 × 65 mm	5000	75,17 €
P-51530	klinec AN901/AN902	2,8 × 75 mm	5000	84,59 €
P-51552	klinec AN901/AN902	3,1 × 90 mm	4500	99,82 €

## Príslušenstvo pre BCG/DCG180, CG100



objednávacie číslo	popis	cena s DPH
196351-8	300 ml set	36,86 €
196352-6	600 ml set	100,64 €
197195-9	puzdro pre veľkosť 800ml	71,71 €

### Mazacia pištoľ



objednávacie číslo	popis	cena s DPH
P-90451	mazacia pištoľ	111,22 €
P-90489	náhradná hadica 600mm	8,64 €

# Príslušenstvo pre Lasery



objednávacie číslo	popis	cena s DPH
A-89501	statív 400–1140 mm (5/8")	102,41 €
A-88989	statív s nivelačnou doskou 555–1175 mm (5/8")	639,74 €
P-81315	statív 1000–2700 mm (5/8")	443,47 €
LE00785638	magnetický terč	22,39 €
TK0LEG2000	okuliare	13,63 €
LE00837085	detektor (SK102Z, SK103PZ, SK104Z)	195,17 €
LE00785637	nástenný držiak vrátane 1/4" skrutky (SK102Z, SK103PZ, SK104Z)	136,14 €
LE00785633	magnetický držiak s 5/8" a 1/4" adaptérom (SK102Z, SK103PZ, SK104Z)	20,13 €
LE00785519	adaptér na statív z 5/8" na 1/4" (SK102Z, SK103PZ, SK104Z)	24,64 €
LE00785636	taška (SK102Z)	25,84 €
LE00822220	taška SK103PZ/SK104Z	31,75 €
LE00796587	prijímač (SKR200Z, SK102Z, SK103PZ, SK104Z)	290,38 €
LE00784968	magnetický držiak (SKR200Z)	119,32 €
LE00796588	dialkové ovládanie (SKR200Z)	63,22 €
LE00791661	držiak na stenu s 5/8" skrutkou (SKR200Z)	106,65 €
P-81309	meracia tyč hliníková (4 m)	96,77 €
TKAK400MUN	taška (SK312GD)	213,16 €
TKOLDG301G	laserový prijímač LDG3 (SK312GD)	350,40 €
199010-3	napájací kábel USB (SK312GD)	11,16 €
TK000ET03F	nástenný držiak (SK312GD)	287,14 €



# Príslušenstvo pre Aku viazač armatúr DTR180

objednávacie číslo	popis	Ø (mm)	ks/bal	cena s DPH
199137-9	žiháný viazací drôt	0,8	50	262,41 €





# Benzínové rozbrusovačky



objednávacie číslo	popis	druh/veľkosť	DPC6430 7330	EK6100 7300	DPC6431 7331	EK6101 7301	DPC8132 EK8102	cena s DPH
966121151	rezací kotúč	oceľ / 300 × 20 mm ø	•					14,94 €
966141150		oceľ / 350 × 20 mm ø			•			34,21 €
966121120		kameň / 300 × 20 mm ø	•					11,56 €
966141120		kameň / 350 × 20 mm ø				•		17,07 €
P-27676	diamantové kotúče na betón* asfalt**	rezanie za sucha a za mokra 300 × 20 mm ø*	•					205,63 €
D-56998		rezanie za sucha 355 × 25,4 mm ø*			•			78,14 €
B-13275		rezanie za sucha 355 × 25,4 mm ø**				•		195,51 €
394361621		základný vozík, sivý (len vozík)	•		•			385,98 €
394366612	adaptačná súprava	sivá (k základnému vozíku)	•		•			152,29 €
394362622	obmedzovač hĺbky	sivý, kompletný (k základnému vozíku)	•		•	•		160,40 €
957802600	nádrž na vodu	tlaková nádrž na vodu/10l (3–5 bar)	•		•	•		318,33 €
394365622		spádová nádrž na vodu – súprava/15l	•		•			265,15 €
394365102	vodná armatúra	na tlakovú a spádovú nádrž	•		•	•		70,96 €
010114081	uhlový uzáver nádrže	dopĺňanie paliva	•		•	•		12,56 €
957004006		súprava náradia kompletná	•		•	•		16,42 €
950004002		taška na náradie (prázdna)	•		•	•		1,65 €
782028-7	montážne náradie	kombinovaný kľúč 13 / 19 mm	•		•	•		3,59 €
782025-3		uhlový skrutkovač (torx)	•		•	•		3,69 €
783012-5		skrutkovač (karburátor)	•		•	•		2,38 €
394228121	redukčný krúžok	z 24,5 mm na 20 mm	•		•	•		9,42 €
980008606	olej do dvojtaktných motorov	1 : 50, 100 ml	•		•	•		2,47 €
980008107		1 : 50, 1 liter	•		•	•		9,37 €
168517-0	zapaľovacia sviečka		•		•	•		4,21 €
168652-4		EK7651H						9,80 €
395173090	naolejovaný filter					•		7,46 €
395173081	filter		•		•			15,45 €
442165-6	vzduchový filter	EK7651H						13,18 €
DT4000	vozík	EK7651H						1 149,12 €





# Vrecká a držiaky

## Príslušenstvo k odsávaniu



objednávacie číslo	popis	vhodné pre stroj	ks/bal	cena s DPH
83132B8I		440	5 (20l)	14,97 €
• 83133B8K		440	5 (25l)	18,12 €
83132BEK		445X	5	20,20 €
P-70203		447L/447M	5	67,86 €
P-81804		447L/447M	2	18,15 €
195558-3		VC3211M/L, VC3210L	5	25,78 €
P-70194	papierové vrecká	446L	5	25,46 €
•• 195557-5	• priemyselné vrecko •• vrecko z netkanej textilie na opakované použitie	DVC860L/VC2211M	5	23,60 €
83134B8I		448	5	12,03 €
•• P-72899		VC2010L, VC2511, VC2012L, VC2512L, VC3011L	5	20,37 €
P-84078**		VC3012L/M**		33,62 €
P-78293		VC3511L	5	35,43 €
•• W107418353		VC4210L/M	5	36,45 €
••• W107418354		VC4210L/M	1	194,02 €
195440-6		VC3210LX1, VC3211M/H	5	10,55 €
P-70297		446L, VC2010L, VC2012L, VC2511, VC2512L, VC3011L, VC3511L	5	38,69 €
P-70306		447L	5	49,83 €
195432-5	vak na prach – nepriepustná fólia	DVC860L	10	9,30 €
P-80575		447L/M	2	16,93 €
W107418355		VC4210L/M	5	29,87 €
443060-3		4071D	1	0,66 €
166084-9	papierový filter	4072D, 4073D, 4013D, 4093D	1	0,79 €





# Filtre

## Príslušenstvo k vysávaniu

	objednávacie číslo	Názov	Pre model	cena s DPH
	83203BJA		440	56,73 €
	83202BDG		448	51,15 €
	83203BDG		448	60,98 €
	P-70219		446L, VC2010L, VC2012L, VC2511, VC2512L, VC3011L, VC3511L	32,23 €
	P-70225	Papierové filtre • BGIA filter •• Filter s držiakom	447L	73,44 €
	• 83202BEB		445X, 448	51,60 €
	•• 83140H0G		449	138,92 €
	196252-0		VC3211M, VC2211M	16,09 €
	W107418352		VC4210L/M	32,31 €
	196253-8	• Prefilter	prefilter VC3211M/H, VC2211M	15,21 €
	195553-3	•• Prefilter pre mokré vysávanie	DVC860L	25,62 €
	83035BHB	Polyuretánový filter pre mokré vysávanie	440, 448, 445X	7,59 €
	83035H0B		449	30,98 €
	83100BJA	Nylonový filter • Polyester	440	30,94 €
	83038B5A		445X	38,69 €
	W107418351	HEPA filter	VC4210L/M	65,12 €
	W302000606	plátený filter	446	102,88 €



# Príslušenstvo k aku vysávačom



objednávacie číslo	popis	vhodné pre stroj	Ø priemer (mm)	cena s DPH
122520-5		4073D, 4093D, 4013D	28	6,36 €
122859-6		DCL140Z, DCL180Z, CL100, CL102, DVC182Z, CL183DZ	28	6,19 €
SH00000058	hubica široká	DCL500Z	28	25,94 €
198149-9		vhodné pre všetky modely	28	12,32 €
198527-3		vhodné pre všetky modely	28	16,47 €
198552-4		vhodné pre všetky modely	28	5,79 €
198553-2	hubica tvar o	vhodné pre všetky modely	28	5,56 €
140456-6	hadica	BVC340Z, BVC350Z	28	33,48 €
198544-3	hadica	všetky aku vysavače Makita	28	7,19 €
191724-0	kefa	všetky aku vysávače	28	7,48 €
132025-7	hubica	BVC340Z, BVC350Z	28	3,62 €
416041-0		4073D, 4093D, 4013D, CL070DS, CL100D, CL104	28	0,56 €
451243-1	hubica štrbinová	CL100, CL102, DCL140Z, DCL180Z, DVC182Z, CL183DZ	28	0,68 €
198990-0	hubica štrbinová dĺžka 300 mm	vhodné pre všetky modely	28	2,04 €
416042-8		4073D, 4093D, 4013D	28	4,91 €
451424-7	predlžovacia trubka	DCL140, DCL180, CL070DS, CL100D, CL102, CL104, DVC182Z, CL183DZ	28	1,77 €
SH00000040		DCL500Z	28	72,81 €
443060-3	vrecko na prach 1ks	CL070D, CL100D, DCL140Z, DCL180Z, DVC182Z, CL183DZ		0,66 €
166084-9	vrecko na prach 1ks	CL102D, 4073D, 4093D, 4076D		0,79 €
194566-1	vrecko na prach 5 ks	CL102D, 4073D, 4093D, 4076D, CL104, DVC182Z, CL183DZ		3,66 €
451208-3	predfilter	CL070D, CL100D, DCL140Z, DCL180Z		1,44 €



# Hubice a trubice

## Príslušenstvo pre vysávanie



objednávacie číslo	popis	vhodné pre stroj	poznámka	cena s DPH
50091B0N	predlžovacia trubica	440, 445X, 448, 449		25,79 €
40021B5N	otočná prípojka chrómovaná	449		48,44 €
P-70346		VC4210L/M, VC3012L/M, 446,447L, 447M	31,92 €	
192562-3		VC3210LX1, VC3211H/M, VC2211M, DVC860L	hliník	5,97 €
P-70437	predlžovacia trubica	446L, 447L	Ø 36 mm 2 × 515 mm	46,40 €
P-72942	predlžovacie trubice plastové čierne	443, 446L, 447L, VC2010L, VC2511, VC3511L	Ø 36 mm 2 × 520 mm	29,73 €
192563-1		VC3210LX1, VC3211H/M, VC2211M, DVC860L	hliník	5,68 €
412040-0	plastová trubica	4037D, 4071/2D, 4091/2D		3,55 €
W107418350	predlžovacia trubica chróm	VC4210L/M	Ø 35 × 350 mm 3ks	32,64 €
P-81745	štrbinová hubica	VC2012L, VC2512L, VC3011L	Ø 35 × 200 mm	19,33 €
132025-7	gumová hubica	4014NV, UB1101, UB120D, BUB182Z		3,62 €
50089B0N	trojuholníková hubica	440, 445X, 448, 449		8,31 €
50080B0N	štrbinová hubica	440, 445X, 448, 450		10,33 €
W6084		446L, 447L, VC2010L, VC3012L/M, VC4210L/M pozn. ø 35 × 300	290 mm	4,57 €
416041-0	štrbinová hubica	4072D, 4073D, 4093D, UB120D		0,56 €
411891-8		4071D, 4072D, 4073D, 4092D, UB1101, UB140D		1,13 €
410306-2		VC3210LX1, VC3211H/M, DVC860L, VC2211M	330 mm	1,72 €
60277B0N	hubica široká – základňa	440, 445X, 448		12,89 €
60278B0N	kefa pre mokré vysávanie	440, 445X, 448		10,45 €
60279B0N	kefa pre suché vysávanie	440, 445X, 448		10,35 €



# Hubice a trubice

Príslušenstvo pre vysávanie



objednávacie číslo	popis	vhodné pre stroj	poznámka	cena s DPH
P-72964	hubica pre mokré vysávanie	446L, 447L, VC2010L		81,14 €
W14295	hubica na vankúše	VC2010L, VC2511, VC3511L		3,06 €
W107417892	hubica kobercová	443, 446L, 447L, VC2010L, VC2511, VC3511L		61,05 €
P-70471	hubica s kefou	446L, 447L, VC2010L, VC2511, VC3511L		11,49 €
60005B5N	hubica na priemyselné podlahy 400 mm	449		36,10 €
60007B5N	hubica na mokré vysávanie 400 mm	449		40,08 €
122520-5	hubica	4013D, 4073D, 4093D		6,36 €
122234-6	hubica	4071D, 4091D, 4092D		10,57 €
195551-7	hubica	VC3210LX1, VC3211H/M, DVC860L, VC2211M		23,83 €
W107402706	hubica	VC2012L, VC2512L, VC3011L		13,32 €
P-81789	hubica na podlahy 300mm	VC3012L/M, VC4210L/M		21,67 €
191657-9	hubica tvar o ø 38mm			13,87 €

# Sady

Príslušenstvo pre vysávanie pre vysávače 446L, 447L a VC2010L / VC2511 / VC3511 L



objednávacie číslo	obsah sady	cena s DPH
P-70312	1. predĺžovacia trubica 2 ks 2. otočná prípojka chrómovaná 3. hubica kobercová 4. štrbinová hubica 5. hubica s kefou 6. hubica na vankúše 7. plastový držiak	100,20 €
P-70328	1. predĺžovacia trubica 2 ks 2. otočná prípojka chrómovaná 3. hubica podlahová 4. hadica priem. 36 mm, 4 m	122,47 €
W302002734	1. predĺžovacia trubica 2 ks 2. hadica priem. 27 mm, 3 m s prípojkou 3. hubica podlahová 4. štrbinová hubica 5. hubica s kefou 6. hubica na vankúše	87,09 €



# Hadice a adaptéry

## Príslušenstvo na odsávanie/vysávanie



objednávacie číslo	popis	vhodné pre stroj	priemer (mm)	dĺžka (m)	cena s DPH
02300B0N		440, 445X, 448	25	3	72,88 €
195433-3	ohybná hadica	VC3210LX1, VC3211H/M, VC2211M, DVC860L	28	3,5	60,58 €
195434-1		VC3210LX1, VC3211H/M, VC2211M, DVC860L	38	2,5	72,77 €
01319B0N		440, 445X, 448	45	4	72,86 €
P-70487	ohybná hadica	446L/447L/447MX	27	3,5	83,47 €
W15365	hadica s apdatérom	P-70421, 446L/447L/447MX	36	4,0	58,87 €
192108-5	hadica	440, 445X, 448	19	2,5	27,03 €
P-84084	hadica	VC3012L/M, VC4210L/M	32	4	69,46 €
•• P-70487	hadica • s integrovanou rukoväťou •• antistatická	446L, 447L, VC2010L, VC2511, VC3511L	27	3,5	83,47 €
• P-72914		46L, 447L, VC2010L, VC2511, VC3511L	32	3	70,47 €
P-72920		446L, 447L, VC2010L, VC2511, VC3511L	36	3	39,26 €
•• P-70362		446L, 447L	36	3	129,87 €
P-81739		VC2012L, VC2512L, VC3011L	32	3,5	36,69 €
01316B0N	hadica s integrovanou rukoväťou	440, 445X, 448	45	2	61,78 €
50096B0N	rukoväť bez regulácie	440, 445X, 448			16,16 €
50095B0N	regulácia k rukoväti	440, 445X, 448			8,74 €
P-72908	rukoväť s reguláciou	VC2010L, VC2511, VC3511L			22,41 €



# Adaptéry na hadice vysávačov

objednávacie číslo	popis	poznámka	Ø adaptéru (mm)	pre vysávač	cena s DPH
50075B0N	adaptér hadice (k vysávaču)	pre hadicu 01318B09, Ø 45 mm	60	440/445X/448	4,08 €
P-70409	adaptér hadice (k vysávaču)	pre hadicu P-70487, Ø 36 mm	58	446L, 447L, VC2010L, VC2511, VC3511L	14,47 €
P-70390	adaptér hadice (k vysávaču)	pre hadicu P-70362 a P-72920, Ø 36 mm	58	446L, 447L, VC2010L, VC2511, VC3511L	14,54 €
P-70378	adaptér ku stroju antistatický (použiteľný s krúžkom 213419-6)	pre hadicu s rýchlopínaním	25/38	446L, 447L, VC2010L, VC2511, VC3511L	25,98 €
W107418688	adaptér ku stroju antistatický (použiteľný s krúžkom 213419-6)	pre hadicu s rýchlopínaním	38	446L, 447L, VC2010L, VC2511, VC3511L, VC4210L/M	29,83 €
P-70415	adaptér ku stroju antistatický (použiteľný s krúžkom 213419-6)	pre hadicu P-70487, Ø 27 mm	37/45	446L, 447L, VC2010L, VC2511, VC3511L	9,31 €
213419-6	O krúžok	pre adaptéry ku strojom			2,39 €
P-70421	antistatický adaptér	pre hadicu P-70487, Ø 27 mm	25/38	446L, 447L, VC2010L, VC2511, VC3511L	21,51 €
P-72936	adaptér	pre hadicu P-72914, Ø 32 mm	25/38	446L, 447L, VC2010L, VC2511, VC3511L	11,13 €
195547-8	adaptér 22	pre hadicu 195433-3, Ø 28 mm	22	VC3210LX1, BCV340, BCV350	1,97 €
195546-0	adaptér ku stroju 24	pre hadicu 195433-3, Ø 28 mm	24	VC3210LX1, BCV340, BCV350	2,93 €
195545-2	adaptér 38	pre hadicu 195433-3, Ø 28 mm	38	VC3210LX1, BCV340, BCV350	5,67 €
195547-8	adaptér 22	pre hadicu 195433-3 priemer 28 mm	22	VC3210, VC3211, BCV340, BCV350, DVC860L, VC2211M	1,97 €
195546-0	adaptér 22	pre hadicu 195433-3 priemer 28 mm	24	VC3210, VC3211, BCV340, BCV350, DVC860L, VC2211M	2,93 €
P-81745	adaptér s reguláciou	pre hadicu P-81739 priemer 32 mm	25/38	VC2012L, VC2512L, VC3011L	19,33 €



# Príslušenstvo pre Aku chrbtový vysávač DVC260Z



objednávacie číslo	popis	priemer (mm)	dĺžka (m)	priemer vývodu (mm)	cena s DPH
143787-2	hadica na čistenie/vysávanie	28	1,0		30,54 €
A-34235	hadica pre napojenie so strojmi	28	1,5	22, 38	44,46 €



objednávacie číslo	popis	cena s DPH
123584-2	teleskopická sacia rúra	18,66 €
123677-5	koleno	7,80 €
192236-6	štrbinová hubica použiteľné s hadicou s priemerom 28 mm /priemer vývodu 22 mm/	5,65 €
197901-2	gumená hubica	5,63 €
123486-2	podlahová hubica	9,73 €
A-59950	podlahová hubica so štetinami	19,88 €
166116-2	držiak hadice	0,98 €
195547-8	adaptér priemer vývodu 22	1,97 €
195546-0	adaptér priemer vývodu 24	2,93 €
195545-2	adaptér priemer vývodu 38	5,67 €
195548-6	spojka 22-38	6,49 €
123636-9	Hepa filter	9,47 €
197903-8	flisovú zberné sáčky	26,36 €



## Príslušenstvo pre DVC860LZ, 862LZ, 864LZ



objednávacie číslo	popis	priemer (mm)	dĺžka (m)	priemer vývodu (mm)	cena s DPH
A-34235	hadica pre napojenie so strojmi	28	1,0	22, 38	44,46 €
195437-5	hadica pre napojenie so strojmi	28	2,5	22, 24, 38	52,49 €
195433-3	hadica pre napojenie so strojmi	28	3,5	22, 24, 38	60,58 €
195436-7	hadica pre napojenie so strojmi	28	5	22, 24, 38	80,85 €
195434-1	hadica na čistenie/vysávanie	38	2,5	38	72,77 €
195435-9	hadica na čistenie/vysávanie	38	5	38	123,05 €



objednávacie číslo	popis	cena s DPH
192563-1	sacie nadstavce – rovná trubica	5,68 €
192562-3	sacie nadstavce – zahnutá trubica	5,97 €
410306-2	sacie nadstavce – štrbinová hubica	1,72 €
195551-7	hubica – univerzálny nadstavec suché/mokrú	23,83 €
195549-4	hubica – užší nadstavec a	21,28 €
195550-9	hubica – užší nadstavec b	20,01 €
A-47846	hubica – široký nadstavec	42,76 €
195544-4	držiak kábla 10–33	0,82 €
195547-8	adaptér – priemer vývodu 22	1,97 €
195546-0	adaptér – priemer vývodu 24	2,93 €
195545-2	adaptér – priemer vývodu 38	5,67 €
195548-6	spojka 22–38	6,49 €
*197166-6	prachový filter	69,59 €
195553-3	predfilter	25,62 €
140248-3	textilný filter	15,99 €
195555-9	filter na mokré vysávanie	43,61 €
195432-5	zberný sáčok igelitový 10 ks / bal	9,30 €
195557-5	zberný sáčok textil 5 ks / bal	23,60 €

## Príslušenstvo pre DRC200Z



objednávacie číslo	popis	cena s DPH
SH00000231(EU)	páska na vytýčenie hranice (15 m rolka)	55,72 €
SH00000065	bočné kefy	53,81 €
SH00000063	výkonná kefa	81,12 €
SH00000064	kryt rotačnej kefy	38,43 €
SH00000213	filter	82,48 €

## Sada príslušenstva pre vysávače DVC860LZ, 862LZ, 864LZ



objednávacie číslo	popis	cena s DPH
195439-1	195434-1/hadica ø38mmx2,5m	106,60 €
	192563-1/trubica rovná, hliník/	
	192562-3/trubica zahnutá, hliník/	
	410306-2/štrbinová hubica, plast/	
	195551-7/univerzálny nadstavec	

## Rozmery adaptérov na odsávanie





# Adaptéry na odsávanie

## Príslušenstvo na odsávanie

objednávacie číslo	popis	vhodné pre stroj	priemer (mm)	cena s DPH
192176-8	sada na odsávanie pre kladivá	HR2010, BHR200, DHR162, DHR164, DHR165	25	52,45 €
193472-7		DHR262, HR2450, HR2020, HR2440, HR2460, HR2470, HR2810, HR2811, DHR261, DHR241, DHR202	25	48,61 €
193794-5	odsávací adaptér pre uhlové brúsky	Ø 115/125 mm		138,65 €
194044-1		Ø 180-230 mm		234,20 €
196845-3	kryt kotúča s odsávacím adaptérom s vývodom 38 mm		125	86,00 €
JPA122275	odsávací adaptér pre hoblíky	1902, 1911B, 1923H, N1923B		5,68 €
181575-9		1806B, KP312S		6,14 €
191726-6		1901, 1902		5,65 €
192065-7		1923B, 1923H		5,71 €
193733-5	nástavec pre odsávanie	K312S		39,90 €
414468-8		1911B		2,73 €
152122-3		N1923B		3,94 €
451329-1		KP0800		1,57 €
416368-8	odsávací adaptér	LF1000, KP0800, KP0810/C, DKP180		2,10 €
JPA122194		N/1923B		9,92 €
196536-6	odsávacia sada	HR4003C, HR4013C		81,96 €
196858-4		HR5202C, HR5212C		88,32 €
199144-2	odsávanie na sekacie kladivá	SDS-MAX		42,09 €
195179-1	odsávací adaptér pre kladivá	SDS-plus		8,81 €
P-81795	adaptér 50mm	LF1000		42,86 €



# Adaptéry na odsávanie

## Príslušenstvo na odsávanie

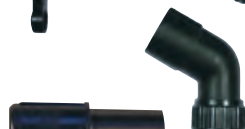
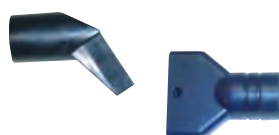

objednávacie číslo	popis	vhodné pre stroj	priemer (mm)	cena s DPH
410899-9	odsávací adaptér pre kefovú pílu	9741		1,25 €
192613-2	odsávací adaptér	4105KB, 9401, PC1100		19,04 €
192504-7	odsávací adaptér	BO4550, BO4553, BO4554, BO4561, BO4563		2,35 €
192518-6	odsávací adaptér	9924DB		15,72 €
192420-3		5603R, 5604R, 5703R, 5704R, 5705R		2,82 €
453289-3		HS6101, HS7101		3,85 €
415816-4		5143R		5,14 €
191879-1		SR2100, SR2300, SR2600		1,94 €
192032-2	odsávací adaptér k okružným pílam	5100BR, 5900BR		1,46 €
450316-7		5104S		8,16 €
194415-2		N5900B		2,37 €
196520-1		HS6601, HS761		2,07 €
416706-4		5621RDWA, BSR730WA		3,46 €
419283-5		BSS610		1,71 €
194314-8	odsávací adaptér	DHS630		6,88 €
194415-2		BSS500/501		2,37 €
192547-9		4304 – 4305T, 4331D, 4334D		2,64 €
196022-7	odsávací adaptér	TM3000C		4,05 €
417853-4		4340CT-51FCT, DJV140/180RFE		1,11 €
192035-6		3612BR, 3620		18,59 €
415412-8		3612, 3612C		4,54 €
194934-8	uhlový adaptér	RP1800FX/2300FCX		9,47 €
194733-8		RP0900, RT0700C		3,10 €
122609-9	odsávací adaptér	RP0910, RP1110C		4,64 €
122615-4	uhlový adaptér	RP0910, RP1110C		6,79 €
P-24810	odsávací adaptér	SG150		10,65 €



# Vaky na prach

Príslušenstvo na odsávanie



objednávacie číslo	popis	vhodné pre stroj	cena s DPH
196300-5		1911B	33,32 €
196298-6		1923H	38,21 €
122230-4	vak na prach	N1923B, 1902, 1900B	60,56 €
122793-0		KP0800, KP0810/C, DKP180	20,89 €
STEX122269		1901, 1902	43,69 €
122321-1		4014NV, UB1101, UB140D, UB120D	3,68 €
122918-6	vak na prach	BVC340, BVC350	18,65 €
122814-8		BUB142, BUB182	3,79 €
122297-2		9401, 9402	12,56 €
122296-4		9900B, 9924DB	18,60 €
122329-5	vak na prach	9901	18,08 €
122591-2		9404, 9902, 9903, 9920	17,11 €
122562-9		9403	17,38 €
122548-3		9910, 9911	4,90 €
122330-0		LS1440	15,41 €
122852-0	vak na prach	LS0714, LS1013, LS1016, LS1040, LS1214, LS1216, LH1040, LF1000, DLS713	3,36 €
122351-2		LS0810	5,11 €
JM23100501		LS1018L	3,32 €
122474-6		3901	4,99 €
123150-5		PJ7000	4,98 €
122193-4	vak na prach	PC1100	17,85 €
122853-8		PC5000C, PC5001C	5,33 €
123185-6		4105KB	38,87 €
123241-2		UB1103	6,24 €
122814-8	vak na prach	DUB182	3,79 €
122852-0		LS1019L/LS1219L	3,36 €

# Prípojenie stroja k vysávačom

A	B	C	D	E	F	G
W/ Ø28mm hadica	W/ Ø28mm hadica	W/ Ø28mm hadica	W/ Ø38mm hadica	W/ Ø28mm hadica	W/ Ø32mm hadica	W/ Ø32mm hadica
Model VC3211H VC3211M VC2211M VC3210L	Model VC2510L VC1310L DVC861L DVC863L DVC864L	Model DVC350	Model DVC860L DVC861L DVC862L DVC863L	Model DVC260	Model VC2012L VC2512L VC3011L	Model VC3012L VC4010L VC3012M VC4010M
W/ ø koncovky hadice 38 24 22	W/ ø koncovky hadice 38 24 22	W/ ø koncovky hadice 38 24 22	W/ adaptér 22-38	W/ ø koncovky hadice 38 24 22	W/ adaptér 24 W/ adaptér 38 (voliteľný) P-81745 P-70421	W/ adaptér 24 38 P-70378 W10741868

modely	pripojenie k vysávaču
--------	-----------------------

<p><b>vŕtacie a búracie kladivá</b></p> <p>(len pri sekani) 199144-2 (w/hose for) 199143-4 (w/o hose for)</p> <p>hadica s ø 28 mm môže byť pripojená na priamo</p> <p><b>17mm(11/16")Hex:</b> HM0830,HR3530, HR4030C</p> <p><b>SDS-MAX:</b> HR4001C/02/10C/11C, HR4501C/10C/11C, HR3540C/41FC HM0870C/71C, HM1101C/11C, HM1203C/13C, HM1214C HR4501C/10C/11C, HR4013C HR4003C, HR3540C/41FC</p> <p>DHR400, HR5202C, HR5212C, HM1205</p> <p><b>19mm(3/4")Hex:</b> HR4041C</p>	<p><b>odsávací adaptér</b></p> <p><b>príame pripojenie</b></p> <p><b>príame pripojenie</b></p> <p><b>príame pripojenie</b></p> <p><b>ø28mm hadica</b></p> <p><b>príame pripojenie</b></p> <p><b>s adaptérom 24</b></p> <p><b>s adaptérom 24</b></p>
<p><b>búracie kladivá</b></p> <p>HM1304/B, HM1306, HM1317C/CB, HM1307C/CB, HM1400, HM1500/B, HM1810, HM1801, HM1812, HM1802</p> <p>197168-2 (w/o hose for) 197148-8 (w/ hose for)</p> <p>hadica s ø 28 mm môže byť pripojená na priamo</p>	<p><b>odsávací adaptér</b></p> <p><b>príame pripojenie</b></p> <p><b>s adaptérom 24</b></p> <p><b>s adaptérom 24</b></p>

modely	pripojenie k vysávaču
--------	-----------------------

<p><b>vŕtacie a sekacie kladivá</b></p> <p>DHR242, HR2300, HR2600 HR2601/F, HR2610, HR2611F, HR2630, HR2631F, HR2641, HR2650, HR2651, HR2661, DHR280, DHR282</p> <p>DHR243, HR2320T, HR2610T HR2611FT, HR2630T, HR2631FT, HR2651T, DHR281, DHR283</p> <p>BHR262, DHR164, DHR165, DHR171, DHR202, DHR241, DHR263, HR140D, HR166D, HR1840, HR1841F, HR1830, HR1830F, HR2230, HR2432, HR2460/F, HR2470/F, HR2475, HR2800, HR2810, HR2811F</p>	<p><b>odsávací adaptér</b></p> <p>195179-1</p> <p>195179-1</p> <p>195179-1</p> <p><b>odsávací adaptér</b></p> <p>193472-7</p> <p><b>odsávací adaptér</b></p> <p>195866-2</p> <p>(Max. Bit Diameter 40mm)</p>
<p><b>vŕtacie a sekacie kladivá</b></p> <p>DHR164, DHR165 DHR202, BHR262/T DHR263, DHR264</p> <p>HR2470 series HR2800 series</p>	<p><b>príame pripojenie</b></p> <p><b>ø koncovky hadice 22</b></p> <p><b>ø koncovky hadice 22</b></p> <p><b>ø koncovky hadice 22</b></p> <p><b>adaptér 22-38</b></p> <p>195548-6</p> <p><b>ø koncovky hadice 22</b></p> <p><b>adaptér + adaptér 25-50</b></p> <p>192349-3</p> <p><b>adaptér 38 + adaptér 22-38</b></p> <p>195548-6</p>
<p><b>vŕtacie kladivá</b></p> <p>HR4002, HR4011C, HR4010C, HR4001C, HR4511C, HR4510C, HR4501C</p> <p>DHR400, HR4013C, HR4003C HR5212C, HR5202C</p>	<p><b>príame pripojenie</b></p> <p><b>s adaptérom 24</b></p> <p><b>s adaptérom 24</b></p>

Položky štandardného vybavenia a špecifikácií sa môžu líšiť podľa krajiny alebo oblasti.



# Pripojenie stroja k vysávačom

modely	pripojenie k vysávaču
4112H 4112HS 4114 4114S	<b>adaptér 32</b> 192613-2
4105KB	<b>adaptér 32</b> 192613-2
4100KB	
4157KB	
SG1251, SG1250	
PC5000C, PC5001C	
	<b>odsávací adaptér</b> pre brúsenie diamantovým kotúčom
pre modely 115, 125 mm	195239-9
pre modely 180 mm	195385-8

**A**

ø koncovky hadice 38

**B**

ø koncovky hadice 38

**C**

ø koncovky hadice 38

**D**

**E**

ø koncovky hadice 38

**F**

adaptér 38

**G**

adaptér 38

modely	pripojenie k vysávaču
pre 125 mm Model	<b>odsávací adaptér</b> 196845-3
pre 230 mm Model	198440-5
pre 115, 125 mm Model	<b>odsávací adaptér</b> 193794-5
pre 180 mm Model pre 230 mm Model	194044-1
9924DB	<b>adaptér 32</b> 192518-6
9404, 9902, 9903, 9910, 9911, 9920,	
9403, 9921	<b>adaptér 32</b> 192349-3
9741	<b>adaptér</b> 410899-9

**A**

ø koncovky hadice 38

**B**

ø koncovky hadice 38

**C**

ø koncovky hadice 38

**D**

**E**



ø koncovky hadice 38

**F**

adaptér 38

**G**

adaptér 38

Položky štandardného vybavenia a špecifikácií sa môžu líšiť podľa krajiny alebo oblasti.



# pripojenie stroja k vysávačom

modely	pripojenie k vysávaču
9032	<b>adaptér</b> 122652-8
9031	
9046, BO3700, BO3710, BO3711, BO4900/V, BO4901, BO4555, BO4556, BO4565, BO4566, BO4557, BO4558	
BO5012, BO5030, BO5031, BO5040, BO5041, BO6030, BO6040, DBO140, DBO180	
	<b>odsávací adaptér</b>
DTM50, DTM40	195965-0
TM3000C	196022-7
TM3010C	196550-2
DTM51, DTM41	196765-1
	<b>odsávací adaptér</b>
DHS630	194314-8
DSS611, DSS610	419283-5
DSS501, DSS500	194415-2
JV100D, JV143D, JV183D, 4326, 4327, 4328, 4329, JV0600	
	<b>odsávací adaptér</b> 417853-4
DJV140, DJV180, 4350T/CT/FCT, 4351T/CT/FCT	



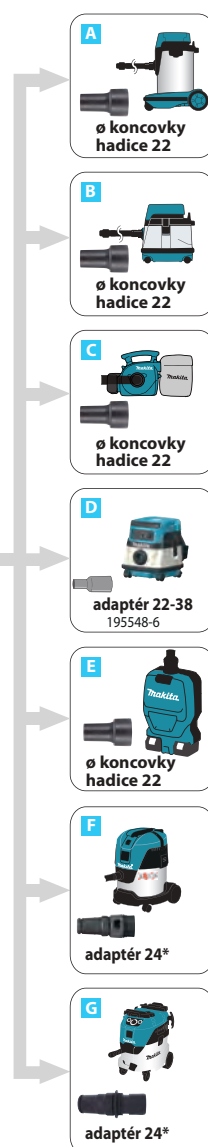
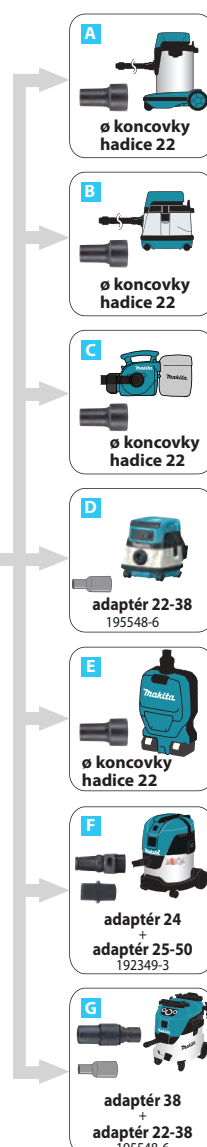



modely	pripojenie k vysávaču
9031	<b>ø koncovky hadice 24</b> 195546-0
HS6100, HS6101, HS7100, HS7101	453289-3
DHS710, HS6600, HS6601, HS7010, HS7600, HS7601, HS7610, HS7611	196520-1
HS6600, HS7000, HS7600, DHS711	196843-7 (with short lever)
HS0600	198263-1
	198265-7 (with short lever)
DHS680	196961-1
	196952-2 (with short lever)
HS7000, HS7600	196520-1
	197221-4 (with short lever)
	<b>ø koncovky hadice 24</b> 195546-0
SP6000	<b>ø koncovky hadice 24</b> 195546-0
DSP600, DSP601	
CA5000	
	<b>adaptér</b>
DJV141, DJV142, DJV181, DJV182, DJV102D, JV103D	126331-0
	457801-1
	<b>ø koncovky hadice 24</b> 195546-0
LS1019/L, LS1219/L	<b>ø koncovky hadice 24</b> 195546-0
DLS110, DLS111, DLS112	







\* nie je potrebný pri koncovke hadici s ø 24mm

Položky štandardného vybavenia a špecifikácií sa môžu líšiť podľa krajiny alebo oblasti.

# pripojenie stroja k vysávačom

modely	pripojenie k vysávaču
DLS713 DLS714	<b>A</b>  ø koncovky hadice 38
LS0714/F/FL/L LS0815F/FL LS1016L LS1017L LS1018/L LS1216/L	<b>B</b>  ø koncovky hadice 38
LS1030N, LS1440	<b>C</b>  ø koncovky hadice 38
LS1040/F, LS1045, LS1221	<b>D</b> 
DLS600	<b>E</b> 
LF1000	<b>F</b>  adaptér 38
LH1040/F LH1201FL	<b>G</b>  adaptér 38

modely	pripojenie k vysávaču
2704, 2705	adaptér 419093-0 
MLT100	adaptér JM27000090 
2712	<b>E</b> 
LB1200F	adaptér 419093-0 



Položky štandardného vybavenia a špecifikácií sa môžu líšiť podľa krajiny alebo oblasti.

# pripojenie stroja k vysávačom

modely	pripojenie k vysávaču
<p><b>adaptér</b></p> <p>5603R, 5704R, 5705R — 192420-3</p> <p>5143R — 415816-4</p>	<p><b>A</b></p> <p>ø koncovky hadice 38</p>
<p>5103R, 5903R — 415426-7</p> <p>5104S, 5104 — 450316-7</p> <p>N5900B, 5902B — 193068-4 (with short lever)</p>	<p><b>B</b></p> <p>ø koncovky hadice 38</p>
	<p><b>C*</b></p> <p>ø koncovky hadice 38</p>
<p>5604R, 5037NB</p>	<p><b>D</b></p>
	<p><b>E</b></p> <p>ø koncovky hadice 38</p>
<p>5017RKB 5057KB</p>	<p><b>F</b></p> <p>adaptér 38</p>
	<p><b>G</b></p> <p>adaptér 38</p>

**\*C: DVC350, DVC340 nie je možné použiť pri hoblíkoch**

modely	pripojenie k vysávaču
<p>1050D, 1051D KP0810/C</p>	<p><b>A</b></p> <p>ø koncovky hadice 38</p>
	<p><b>B</b></p> <p>ø koncovky hadice 38</p>
<p><b>Nozzle</b></p> <p>DKP180, DKP140 KP0800 — 451329-1</p>	<p><b>C*</b></p> <p>ø koncovky hadice 38</p>
	<p><b>D</b></p>
<p>1805N — JPA122277</p>	<p><b>D</b></p>
<p>N1900B, N1923B, KP0800, 1804N 1805N, 1806B, KP312/S</p>	<p><b>E</b></p> <p>ø koncovky hadice 38</p>
	<p><b>F</b></p> <p>adaptér 38</p>
<p><b>Adaptér</b></p>	<p><b>G</b></p> <p>adaptér 38</p>

**\*C: DVC350, DVC340 nie je možné použiť pri hoblíkoch**



Položky štandardného vybavenia a špecifikácií sa môžu líšiť podľa krajiny alebo oblasti.

## adaptér



## adaptér







\*Elbow









model	obj. č.	model	obj. č.
N1900B, N1923B	152122-3	N1900B, N1923B	122275-2
KP0800, DKP180, DKP140	451329-1	DKP180, DKP140, KP0810/C, KP0800	*416368-8
1805N	122277-6	1804N, 1805N, 1806B, KP312/S	181575-9
1806B	122397-8		
KP312/S	193733-5		
1911B	414468-8		

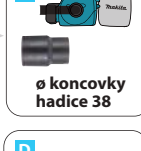

# pripojenie stroja k vysávačom

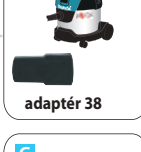
modely	pripojenie k vysávaču
PJ7000, 3901, DPJ180, DPJ140, DPJ181	 <p><b>A</b> odsávací adaptér 193449-2 Ø koncovky hadice 22</p>
	 <p><b>B</b> odsávací adaptér 193449-2 Ø koncovky hadice 22</p>
	 <p><b>C*</b> odsávací adaptér 193449-2 Ø koncovky hadice 22</p>
3706 DCO180	 <p><b>D</b> adaptér 22-38 195548-6</p>
DSD180, SD100D	 <p><b>E</b> odsávací adaptér 192349-3 Ø koncovky hadice 22</p>
	 <p><b>F</b> adaptér 24 adaptér 25-50 192349-3</p>
RP0910, RP110C	 <p><b>G</b> adaptér 38 + adaptér 22-38 195548-6</p>

modely	pripojenie k vysávaču
RP1801/ F RP1800/ F RP2301FC RP2300FC	 <p><b>A</b> odsávací adaptér 194934-8 Ø koncovky hadice 38</p>
	 <p><b>B</b> odsávací adaptér 194934-8 Ø koncovky hadice 38</p>
	 <p><b>C</b> odsávací adaptér 194934-8 Ø koncovky hadice 38</p>
RP0900, ***RT0700C, DRT50	 <p><b>D</b> odsávací adaptér 194733-8</p>
DRT50	 <p><b>E</b> odsávací adaptér 194733-8 Ø koncovky hadice 38</p>
	<p>*** použijte zo základnou doskou</p>
RT0700C	 <p><b>F</b> odsávací adaptér 195559-1 adaptér 38</p>
DRT50	 <p><b>G</b> odsávací adaptér 195559-1 adaptér 38</p>

Firma Makita odporúča použiť 38 mm hadicu pri používaní fréz a hoblíkov.

\*C: DVC350 nie je možné pri frézach



Položky štandardného vybavenia a špecifikácií sa môžu líšiť podľa krajiny alebo oblasti.



# Pripojenie strojov k vysávaču VC3210LX1

stroj	adaptér
1806B	adaptér 38 mm + 414499-7
1901	adaptér 38 mm + 191726-6 + JPA122275
1902	adaptér 38 mm + 191726-6 + JPA122275
1911H	adaptér 38 mm + 414468-8 + JPA122275
1923H	adaptér 38 mm + 192065-7 + JPA122275
2704	adaptér 38 mm + JM27000090
3600B	adaptér 38 mm + 192035-6
3612/C	adaptér 38 mm + 415412-8
3620	adaptér 38 mm + 192035-6
3706	adaptér 22 mm + 193449-2
3901	adaptér 22 mm
4105KB	adaptér 38 mm + 192613-2
4112HS	adaptér 38 mm + 192613-2
4157KB	adaptér 38 mm
4326	adaptér 22 mm
4327	adaptér 22 mm
4329	adaptér 22 mm
4340CT/FCT	adaptér 22 mm + 417853-4
4341CT/FCT	adaptér 22 mm + 417853-4
4350CT/FCT	adaptér 22 mm + 417853-4
4351CT/FCT	adaptér 22 mm + 417853-4
5017RKB	adaptér 38 mm
5103R	adaptér 38 mm + 192419-8
5104S	adaptér 38 mm + 450316-7
5143R	adaptér 38 mm
5603R	adaptér 38 mm + 192420-3
5604R	adaptér 38 mm
5703R	adaptér 38 mm + 192420-3
5704R	adaptér 38 mm + 192420-3
5705R/K	adaptér 38 mm + 192420-3
5900BR	adaptér 38 mm
5903R	adaptér 38 mm + 192419-8
9031	adaptér 22 mm
9032	adaptér 22 mm + 122652-8
9036	adaptér 22 mm
9046	adaptér 22 mm
9402	adaptér 38 mm
9403	adaptér 38 mm
9404	adaptér 38 mm
9741	adaptér 38 mm + 410899-9
9903	adaptér 38 mm
9910	adaptér 38 mm
9911	adaptér 38 mm
9920	adaptér 38 mm
9924DB	adaptér 38 mm + 192518-6
BO3700	adaptér 22 mm
BO3710	adaptér 22 mm
BO3711	adaptér 22 mm
BO4553	adaptér 22 mm
BO4554	adaptér 22 mm

stroj	adaptér
BO4555	adaptér 22 mm
BO4556	adaptér 22 mm
BO4557	adaptér 22 mm
BO4561	adaptér 22 mm
BO4563	adaptér 22 mm
BO4565	adaptér 22 mm
BO4900v	adaptér 22 mm
BO5010	adaptér 22 mm
BO5012	adaptér 22 mm
BO5020	adaptér 22 mm
BO5021	adaptér 22 mm
BO5030	adaptér 22 mm
BO5031	adaptér 22 mm
BO6030	adaptér 22 mm
BO6040	adaptér 22 mm
DBM080/130	adaptér 38 mm
GA9030X01	
GA9050R	
JV0600K	adaptér 22 mm
KP0800	adaptér 38 mm + 451329-1 + 416368-8
KP0810/C	adaptér 38 mm
KP312S	adaptér 38 mm + 193733-5 + 181575-9
LB1200F	adaptér 38 mm + JM27000090
LF1000	adaptér 38 mm
LH1040	adaptér 38 mm
LH1200FL	adaptér 38 mm
LS0714/FL	adaptér 38 mm
LS1013/L	adaptér 38 mm
LS1016/L	adaptér 38 mm
LS1018	adaptér 38 mm
LS1040	adaptér 38 mm
LS1214/L	adaptér 38 mm
LS1216/L	adaptér 38 mm
LS1440	adaptér 38 mm
MLS100	adaptér 38 mm
MLT100	adaptér 38 mm + JM27000090
N1923B	adaptér 38 mm + 152122-3
PC1100	adaptér 38 mm + 192613-2
PC5000C	adaptér 38 mm
PJ7000	adaptér 22 mm
RP0900	adaptér 38 mm + 194733-8
RP0910	adaptér 22 mm
RP1110C	adaptér 22 mm
RP1800FX	adaptér 38 mm + 194934-8
RP2300FCX	adaptér 38 mm + 194934-8
RT0700C	adaptér 38 mm
RT0700CX2	adaptér 38 mm
SG1250	adaptér 38 mm
SP6000/K	adaptér ku stroju 24 mm + adaptér 22 mm

Adaptér 22 mm = 417765-1  
 Adaptér 24 mm = 424379-9  
 Adaptér 38 mm = 195545-2



# Teplovzdušné pištole



objednávacie číslo	názov	HG5002K HG5012K	HG50VK G551VK	HG650CK G651CK	cena s DPH
P-71439	redukčná hubica		•	•	7,26 €
P-71445	odrazová hubica		•	•	7,54 €
P-71451	tryska na zváranie		•	•	8,82 €
P-71473	tryska pre rýchle zváranie <i>použiteľné iba s P-71451</i>	•	•	•	18,72 €
P-71489	tryska pre zváranie preplátovaním	•	•	•	8,85 €
P-71417	hubica chrániaca sklo pred poškodením	•	•	•	7,43 €
P-71423	široká hubica	•	•	•	7,39 €
P-71504	prítlačný valček	•	•	•	8,73 €
P-71495	reflektor spájkovacej dýzy	•	•	•	8,89 €
P-71510	súprava zváracích tyčiniek (PP)	•	•	•	24,40 €
P-71526	súprava zváracích tyčiniek (HDPE)	•	•	•	23,27 €
P-71532	súprava zváracích tyčiniek (ABS)	•	•	•	27,86 €
P-71554	SET škrabka	•	•	•	17,53 €



# Lampy



objednávacie číslo	napätie (V)	model	cena s DPH
STEXML705	7,2	ML705	31,16 €
STEXML101	10,8	ML101	33,80 €
DEADML145	14,4	DML145	29,87 €
DEAML102	7,2/10,8V	ML102	44,29 €
DEAML103	12V max	ML103	35,01 €
DEAML104	12V max	ML104	122,05 €
DEAML105	12V max	ML105	70,34 €
DEAML106	12Vmax	ML106	73,51 €
STEXML187	14,4/18V G -SERIA	ML187	39,17 €





# Lampy



objednávacie číslo	napätie (V)	model	cena s DPH
DEADML185	18	DML185	33,92 €
STEXBML360	36	DML360	69,82 €
D-41838			10,09 €
DEADML801	14,4 a 18		60,59 €
DEADML802	14,4 a 18	DML802	63,73 €
DEADML186	18	DML186	19,64 €
DEADML146	14,4	DML146	26,78 €
DEADML805	14,4/18V	ML805	193,03 €
DEADML808	14,4/18V	ML808	73,33 €
GM00001683	magnet na lampy		17,11 €



# Svietidlá

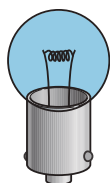
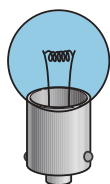

objednávacie číslo	popis	napätie (V)	model	cena s DPH
192242-1		7,2	ML702	5,33 €
192545-3		9,6	ML902 ML903	4,99 €
A-30673		9,6-12	ML121	5,64 €
A-83973	žiarovka 2 ks/balenie (náhradná)	9,6	ML120 ML124	4,97 €
		14,4	ML140 ML141 DML145	
A-30542		18	ML180 DML185	5,93 €
A-87373		24	DML240	7,16 €
B-07303	xenónová žiarovka 2 ks/balenie (náhradná)	14,4-18	DML184	6,26 €
678046-0		7,2	ML701	15,34 €
A-87367	žiarivka 2 ks/balenie (náhradná)	9,6-12	ML122	6,36 €
		14,4	ML142	
GM00001161		14,4-18	DML184	2,99 €
B-14093		36	DML360	13,42 €
GM00001359	led svetlo		DML805	29,51 €
GM00001213	led svetlo		DML802	10,90 €
GM00001694	led svetlo		ML104	28,23 €

## Príslušenstvo pre DEADML805



objednávacie číslo	popis	cena s DPH
GM00001381	statív	83,60 €
GM00001396	svorky upínacie	20,69 €

## Príslušenstvo k Akku kávovaru DCM501



objednávacie číslo	popis	cena s DPH
KF00000020	hrnček	11,94 €
KF00000021	viečko hrnčeka	1,56 €
KF00000033	dávkovač kávy	1,09 €





# PRÍSLUŠENSTVO

▣ Príslušenstvo pre záhradu



## Reťaze pre akku píly



Makita	Dolmar	Dĺžka lišty	Delenie pílovej reťaze	Šírka drážky	Profil zubu	objednávacie číslo	cena s DPH
DUC122Z	AS-1212 AS-1812 AS-1813	11,5 cm	1/4"	1,3 mm	HM	572 466 742	11,69 €
DUC252Z	AS-3625 AS-3626 AS-3726	25 cm	3/8"	1,3 mm	HM	511 492 740	8,94 €
DUC302Z	AS-3731	30 cm	3/8"	1,1 mm	HM	511 291 746	10,35 €
DUC353Z	AS-3835	35 cm	3/8"	1,1 mm	HM	511 291 752	11,62 €
DUC252Z** DUC254Z* DUC302Z** DUC353Z*	AS1925* AS-3626 C* AS-3835*	25 cm	1/4"	1,3 mm	HM	512 466 760	16,42 €
DUC254Z	AS1925Z	25cm	3/8"	1,1 mm	HM	199075-5	7,67 €

\* záberové kolo obj. číslo 198 259-2

\*\* záberové kolo obj. číslo 221528-7

## Lišty pre akku píly



Makita	Dolmar	Dĺžka lišty	Delenie pílovej reťaze	Šírka drážky	objednávacie číslo	cena s DPH
DUC122Z	AS-1212 AS-1812 AS-1813	11,5 cm	1/4"	1,3 mm	660 158 479	25,30 €
DUC252Z	AS-3625 AS-3626 AS-3726	25 cm	3/8"	1,3 mm	168 406-9	8,89 €
DUC302Z	AS-3731	30 cm	3/8"	1,1 mm	442 030 611	10,43 €
DUC353Z	AS-3835	35 cm	3/8"	1,1 mm	412 035 611	10,86 €
DUC252Z** DUC254Z* DUC302Z** DUC353Z*	AS1925Z AS-3626 C* AS-3835*	25 cm	1/4"	1,3 mm	168 395-8	48,41 €
DUC254Z	AS1925Z	25cm	3/8"	1,1mm	161846-0	12,37 €

\* záberové kolo obj. číslo 198 259-2

\*\* záberové kolo obj. číslo 221528-7



popis	model	objednávacie číslo	cena s DPH
predĺženie 630-1200mm	DUC122	195595-7	220,47 €







## Príslušenstvo pre akku píly

objednávacie číslo	popis	dĺžka (cm)	BUC12C, UC120D	BUC250, UC250D, DUC252	UC3030AU UC3051A	UC3530AU UC3551A	UC4030AU UC4051A	UC4530AU UC4551A	UC3020AU UC3041A	UC3520AU UC3541A	UC4020AU UC4041A	cena s DPH
419288-5	kryt lišty								•	•	•	2,68 €
419559-0					•	•	•	•				2,63 €
988002256	reťazový olej 1l				•	•	•	•	•	•	•	3,20 €
988002258	reťazový olej 5l				•	•	•	•	•	•	•	14,90 €
953004010	násada pilníku				•	•	•	•	•	•	•	3,56 €
958500162	pilník guľatý priem. 4 mm – 3 ks				•	•	•	•	•	•	•	6,24 €
953003060	pilník plochý				•	•	•	•	•	•	•	10,04 €
958500063	guľatý pilník 4 mm s násadou				•	•	•	•	•	•	•	13,63 €
941713001	kombinovaný kľúč S13				•	•	•	•	•	•	•	3,06 €

## Popruhy pre akku krovinořezy

	Makita	Dolmar	objednávacie číslo	cena s DPH	
	UR100DZ	–			
	DUR181Z	AT-1827H			
	DUR182UZ	AT-1831U			
	DUR184LZ	AT-1832CZ			
	DUR187L/U	–	jednoramenný	125516-5	2,26 €
	DUR188UZ	–			
	DUR189Z	–			
	DUR365UZ	AT-3723U			
	DUR366L	AT-3736C			

# žacie hlavy pre akku krovinořezy

	Makita	Dolmar	závit žacej hlavy	lanko	objednávacie číslo	cena s DPH
	UR100DZ	–	M8×1,25RH	1,65 mm × 8 m	198854-8	11,85 €
	DUR181Z	AT-1827H	spodná časť žacej hlavy		196146-9	4,49 €
	DUR182UZ	AT-1831U	M8×1,25LH	2,0 mm × 3 m	196589-5	16,82 €
	DUR184LZ	AT-1832CZ	M8×1,25RH	2,0 mm × 3 m	197297-1	15,99 €
	DUR187L/U	–	M8×1,25LH	2,0 mm × 3 m	198385-7	10,60 €
	DUR188UZ	–	M8×1,25LH	2,0 mm × 3 m	198385-7	10,60 €
	DUR189Z	–	M8×1,25RH	2,0 mm × 3 m	198971-4	17,58 €
	DUR365UZ	AT-3723U	M10×1,25LH	2,0 mm × 3 m	197296-3	14,64 €
	DUR366L	AT-3736C	M10×1,25LH	2,0 mm × 3 m	197296-3	14,64 €



## žacie nože pre aku vyžínače

	Makita	Dolmar	Šírka noža	Adaptér v balení	objednávacie číslo	cena s DPH
	UR100DZ	–	230 mm	M8×1,25RH	198848-3	11,66 €
	DUR184LZ	AT-1832CZ	255 mm	M8×1,25RH M8×1,25LH M10×1,25LH	198383-1	15,58 €
	DUR187L/U	–	255 mm	M8×1,25RH M8×1,25LH M10×1,25LH	198383-1	15,58 €
	DUR188UZ	–	255 mm	M8×1,25RH M8×1,25LH M10×1,25LH	198383-1	15,58 €
	DUR189Z	–	255 mm	M8×1,25RH M8×1,25LH M10×1,25LH	198383-1	15,58 €
	DUR365UZ	AT-3723U	255 mm	M8×1,25RH M8×1,25LH M10×1,25LH	198383-1	15,58 €
	DUR366L	AT-3736C	255 mm	M8×1,25RH M8×1,25LH M10×1,25LH	198383-1	15,58 €
	DUR361U	AT-3724U	230×1,8×25,4 mm		B-14118	8,58 €

## náhradné plastové nože

	Pre plastový nôž	ks/bal	objednávacie číslo	cena s DPH

# Aku vyžínač /delený/ DUX60



Makita	Dolmar	popis	objednávacie číslo	cena s DPH
DUX60	AC3611	žacia hlava (2mm)	197296-3	14,64 €
DUX60	AC3611	nôž plastový (255mm)	198383-1	15,58 €
DUX60	AC3611	nôž 4zub (230x1,8x25,4mm)	B-14118*	8,58 €
DUX60	AC3611	nadstavec na kosenie trávy	195650-5**	126,17 €
DUX60	AC3611	nadstavec na kosenie trávy	126603-3	97,86 €
DUX60	AC3611	nadstavec na kosenie trávy zahnutý	195524-0	79,08 €
DUX60	AC3611	nadstavec na živý plot	196257-0	237,65 €
DUX60	AC3611	nadstavec na opíľovanie konárov	196101-1	221,27 €
DUX60	AC3611	kultivátor	195709-8	243,19 €
DUX60	AC3611	predĺženie (1m)	196032-4	111,95 €
DUX60	AC3611	kefa gumenná	199338-9	351,63 €
DUX60	AC3611	kefa nylónová	199317-7	349,64 €
DUX60	AC3611	prepravná taška	195638-5	60,48 €
		náhradný plastový nôž pre 198383-1 (12ks/bal)	198426-9	7,04 €

\* s použitím nadstavca 195650-5 /264025-0 matica, 168526-9 podložka noža, 346084-7 podložka, 326518-6 podložka/

\*\* možnosť použitia B-14118 /nôž 4zub/, 198383-1 /nôž plastový/



## Nože pre AR-3733/DUP361

	DUP361 / AR-3733	objednávacie číslo	cena s DPH
	Nôž spodný ☺	197367-6	41,06 €
	Nôž vrchný ☺	197366-8	46,94 €
	Nôž spodný na tvrdé dreveniny ☺	199217-1	118,41 €
	Nôž vrchný na tvrdé dreveniny ☺	199216-3	68,39 €

Nože sú dodávané bez skrutiek a hriadele.

## Akku dúchadlá / postrekovače

	Makita	Dolmar	popis	objednávacie číslo	cena s DPH
	DUB182		nadstavec	132025-7	3,62 €
	DUB183		nadstavec	TP00000199	6,08 €
	DUB361	AG-3729	nadstavec	452123-4	7,47 €
	DU362	AG-3750	nadstavec	455916-8	7,59 €
	DUB362	AG-3750	dýza okruhá	197888-8	55,49 €
	DUB362	AG-3750	dýza plochá	197889-6	13,58 €
	DUB361	AG-3729	popruh	166094-6	3,33 €
	DU362	AG-3750	popruh	166095-4	3,72 €

## Žacie nože pre akku kosačky

	Makita	Dolmar	objednávacie číslo	cena s DPH
	DLM380Z	AM-3738Z	196863-1	9,14 €
	DLM431Z	AM-3743Z	197762-0	12,24 €
	-	AM-3643LG	660 196 060	24,92 €

## Unášače pre aku kosačky

	Makita	Dolmar	objednávacie číslo	cena s DPH
	DLM380Z	AM-3738Z	455130-6	1,16 €
	DLM431Z	AM-3743Z	224444-2 /podložka/	1,50 €
	-	AM-3643LG	224445-0 /podložka/	1,75 €

## Skrutky na uchytenie noža

	Makita	Dolmar	objednávacie číslo	cena s DPH
	DLM380Z	AM-3738Z	266889-8	0,56 €
	DLM431Z	AM-3743Z	266731-3	0,37 €
	-	AM-3643LG	660 266 731	0,67 €

## Nože na trávu

	Makita	Dolmar	objednávacie číslo	cena s DPH
	-	AY-1821LGH	195267-4	32,70 €
	DUM604Z	AX-1821H	195267-4	32,70 €
	UM600DZ	-	195267-4	32,70 €
	UH201DZ	-	195267-4	32,70 €

## Nože na živý plot

	Makita	Dolmar	objednávacie číslo	cena s DPH
	-	AY-1821LGH	198408-1	17,39 €
	DUM604Z	AX-1821H	198408-1	17,39 €
	UM600DZ	-	198408-1	17,39 €
	UH201DZ	-	198408-1	17,39 €

## Žacie nože pre akku plotostrihy

	Makita	Dolmar	objednávacie číslo	cena s DPH
	DUH551	AH-3656 AH-3756	196687-5	143,55 €
	DUH651	AH-3766	196688-3	87,45 €
	DUH523	AH-1852H AH1853H	195772-1	36,82 €
	DUH601/ DUH602		199099-1*	cena na vyžiadanie
	DUH601/ DUH602		199599-1	cena na vyžiadanie
	DUH751		199100-2*	cena na vyžiadanie
	DUH751		199600-2	cena na vyžiadanie

\* nožnica so špeciálnymi zubami

## Kryty nožov

	Makita	Dolmar	objednávacie číslo	cena s DPH
  	DUH551	AH-3656 AH-3756	450491-9	2,05 €
	DUH651	AH-3766	450492-7	3,40 €
	UH200/201	AH-1020LGEX	451816-0	1,73 €
	UM600		452055-5	1,82 €
	DUM604	AX-1821	452055-5	1,82 €
	UM164		452055-5	1,82 €

## Zachytávač odrezkov

	Makita	Dolmar	objednávacie číslo	cena s DPH
  	DUH551	AH-3656 AH-3756	194681-1	16,03 €
	UH200	AH-1020LGEX	451880-1*	1,40 €
	UH201		457426-1**	2,87 €
	DUM604		457426-1**	2,87 €
	UH201		198402-3***	5,63 €
	DUM604		198402-3***	5,63 €
	DUM168	AX-1820H AX1821H	195229-2	45,03 €
	UM164		195229-2	45,03 €

\*iba pre nožnicu 195272-1, 195243-8; \*\* spodné kryty nožníc na trávu; \*\*\* iba pre nožnicu 198408-1

## Reťaze pre elektrické píly

	Makita	Dolmar	Dĺžka lišty	Delenie pílovej reťaze	Šírka drážky	Profil zuby	objednávacie číslo	cena s DPH
	UC3041A	ES-34TLC	30 cm/12"	3/8"	1,1 mm	HM	958 291 046	10,80 €
	UC3541A	ES-39TLC	35 cm/14"	3/8"	1,1 mm	HM	958 291 052	12,07 €
	UC4041A	ES-43TLC	40 cm/16"	3/8"	1,1 mm	HM	958 291 056	12,87 €
	UC4041A	ES-43TLC	40 cm/16"	3/8"	1,3 mm	HM	511 492 756	12,33 €
	UC3051A	ES-2131TLC	30 cm/12"	3/8"	1,3 mm	HM	958 492 046	10,93 €
	UC3551A	ES-2136TLC	35 cm/14"	3/8"	1,3 mm	HM	958 492 052	12,20 €
	UC4051A	ES-2141TLC	40 cm/16"	3/8"	1,3 mm	HM	958 492 056	13,05 €

## Lišty pre elektrické píly











	Makita	Dolmar	Dĺžka lišty	Delenie pílovej reťaze	Šírka drážky	objednávacie číslo	cena s DPH
	UC3041A	ES-34 TLC	30 cm/12"	3/8"	1,1 mm	958 400 001	11,21 €
	UC3541A	ES-39 TLC	35 cm/14"	3/8"	1,1 mm	958 400 002	12,27 €
	UC4041A	ES-43 TLC	40 cm/16"	3/8"	1,1 mm	442 040 611	11,60 €
	UC4041A	ES-43 TLC	40 cm/16"	3/8"	1,3 mm	958 500 051	12,96 €
	UC3051A	ES-2131 TLC	30 cm/12"	3/8"	1,3 mm	958 500 003	11,56 €
	UC3551A	ES-2136 TLC	35 cm/14"	3/8"	1,3 mm	958 500 002	12,07 €
	UC4051A	ES-2141 TLC	40 cm/16"	3/8"	1,3 mm	958 500 051	12,96 €

## Lišty so španovákou pre elektrické píly

	Makita	Dolmar	Dĺžka lišty	Delenie pílovej reťaze	Šírka drážky	objednávacie číslo	cena s DPH
	UC3041A	ES-34 TLC	30 cm/12"	3/8"	1,1 mm / 0.043"	412 030 211	12,72 €
	UC3541A	ES-39 TLC	35 cm/14"	3/8"	1,1 mm / 0.043"	412 035 211	13,98 €
	UC4041A	ES-43 TLC	40 cm/16"	3/8"	1,3 mm / 0.050"	958 400 007	15,64 €







# Vysokotlakové čističe

	(Makita) HW1200 HW1300	(Dolmar) HP-351 HP-401	objednávacie číslo	cena s DPH
	☺	☺	197842-2	12,90 €
	☺	☺	197822-8	7,15 €
	☺	☺	197876-5	15,06 €
	☺	☺	197824-4	7,71 €
	☺	☺	198909-9	22,68 €
	☺	☺	197879-9	1,08 €
	☺	☺	197870-7	31,73 €
	☺	☺	197831-7	10,59 €
	☺	☺	197828-6	5,19 €
	☺	☺	197886-2	11,80 €

# Vysokotlakové čističe

	(Makita) HW1200 HW1300	(Dolmar) HP-351 HP-401	objednávacie číslo	cena s DPH
	☺	☺	197864-2	13,00 €
	☺	☺	197837-5	16,69 €
	☺	☺	197840-6	21,11 €
	☺	☺	197845-6	18,27 €
	☺	☺	197847-2	25,51 €
	☺	☺	197850-3	30,19 €
	☺	☺	197867-6	9,23 €
	☺	☺	197873-1	21,32 €
	☺	☺	197853-7	4,05 €
	☺	☺	197881-2	2,77 €
	☺	☺	197883-8	2,77 €





# Vysokotlakové čističe

	(Makita) HW102 (Dolmar) HP-20	(Makita) HW111 (Dolmar) HP-300	(Makita) HW112 (Dolmar) HP-350	(Makita) HW132 (Dolmar) HP-450	(Makita) HW151 (Dolmar) HP-7000	objednávacie číslo	cena s DPH
	☺	☺	☺			3320152	4,99 €
				☺		3640920	19,95 €
					☺	41154	18,29 €
	☺					609 640 640	2,04 €
		☺	☺			3640650	2,39 €
				☺		3641150	40,52 €
					☺	40246	21,11 €
	☺	☺	☺			41193	8,82 €
				☺		609 041 195	11,76 €
					☺	609 041 217	55,76 €
	☺					3640630	6,30 €
		☺	☺	☺		609 041 199	61,30 €
					☺	609 041 201	62,22 €
				☺		3640960	77,02 €
	☺	☺	☺	☺	☺	40863	32,35 €











## Vysokotlakové čističe

	(Makita) HW102 (Dolmar) HP-20	(Makita) HW111 (Dolmar) HP-300	(Makita) HW112 (Dolmar) HP-350	(Makita) HW132 (Dolmar) HP-450	(Makita) HW151 (Dolmar) HP-7000	objednávacie číslo	cena s DPH
	☺	☺	☺	☺	☺	40864	65,88 €
	☺	☺	☺	☺	☺	609 041 207	48,76 €
	☺	☺	☺	☺	☺	609 041 209	16,17 €
	☺	☺	☺	☺		41150	31,62 €
	☺	☺	☺	☺	☺	40855	13,67 €
	☺	☺	☺	☺	☺	3082130	0,90 €
					☺	41849	53,87 €
	☺	☺	☺	☺	☺	40724	13,18 €

# Vysokotlakové čističe

	(Makita) HW101 (Dolmar) HP-10	(Makita) HW110 (Dolmar) HP-115	(Makita) HW130 (Dolmar) HP-135	(Makita) HW131 (Dolmar) HP-1500	objednávacie číslo	cena s DPH
	☺				40797	10,91 €
	☺				40798	5,67 €
		☺			609 040 878	13,88 €
			☺		40879	12,20 €
				☺	609 040 886	24,16 €
		☺			609 040 880	12,50 €
			☺		40721	10,22 €
				☺	40867	35,14 €
	☺				40799	11,75 €
		☺			609 040 856	19,92 €
			☺		609 040 857	28,60 €
				☺	609 040 858	134,52 €
		☺	☺		40863	32,35 €
		☺	☺		40864	65,88 €
				☺	609 040 865	41,17 €

# Vysokotlakové čističe

	(Makita) HW101 (Dolmar) HP-10	(Makita) HW110 (Dolmar) HP-115	(Makita) HW130 (Dolmar) HP-135	(Makita) HW131 (Dolmar) HP-1500	objednávacie číslo	cena s DPH
				☺	609 040 866	69,06 €
		☺	☺		609 040 859	28,30 €
				☺	609 040 860	30,13 €
	☺	☺	☺		40869	21,68 €
				☺	609 040 870	12,85 €
		☺	☺		609 040 896	26,23 €
				☺	609 040 897	21,00 €
		☺	☺	☺	40855	13,67 €
		☺	☺		609 040 874	89,58 €
		☺	☺		609 040 875	108,06 €
				☺	41849	53,87 €

# Vysokotlakové čističe

	popis	model	objednávacie číslo	cena s DPH
	striekacia pištoľ	HW120	40883	46,81 €
	predĺženie	HW120	3718	39,47 €
	variabilná dýza	HW120	3195	22,33 €
	vysokotlaková hadica 8m	HW120	3163270	240,26 €
	vysokotlaková hadica predĺžovacia 15m	HW120	40106*	217,17 €
	filter	HW120	50713	20,60 €
	vysokotlaková hadica 8m	HW121	3640960	77,02 €
	turbotryska	HW121	41171	20,30 €
	striekacia pištoľ	HW140	41154	18,29 €
	variabilná dýza	HW140	40246	21,11 €
	vysokotlaková hadica 10m	HW140	3083550	109,30 €
	vysokotlaková hadica predĺžovacia 8m	HW140	41183	91,26 €
	turbotryska s nadstavcom	HW140	40167	68,81 €
	filter	HW140	3082130	0,90 €

\*s použitím predĺženia nie je možné nasávať čistiaci prostriedok





# Odkladacie systémy

popis	objednávacie číslo	cena s DPH	popis	objednávacie číslo	cena s DPH
taška na náradie 	P-80977	46,82 €	držiak na telefón 	P-80896	11,49 €
taška na náradie s organizátorom 	P-80949	78,65 €	traky na opasok 	P-80612	30,91 €
taška na náradie (priemyselná) 	P-80955	67,72 €	opasok na náradie HEAVY DUTY 	P-80911	35,24 €
univerzálny držiak na náradie 	P-80933	23,65 €	HEAVY DUTY opasok – set 	P-80927	83,17 €
organizár na drobné náradie 	P-80868	16,33 €	univerzálna taška s opaskom 	P-80905	29,64 €
púzdro na skrutky 	P-80874	10,78 €	taška na lištu dĺžka do 1000 mm 	B-66905	45,21 €
držiak na skrutkovač 	P-80880	15,25 €	taška na lištu dĺžka do 1500 mm 	B-57613	50,82 €
taška na náradie otvorená 	P-79946	100,69 €			



# Odkladacie systémy



brašna univerzálna  
280 × 250 × 160 mm 0,58 kg, kapsa 1,5l

P-71722

42,39 €



brašna pre elektrikárov  
315 × 250 × 140 mm 0,5 kg, kapsa 1,65l

P-71738

27,54 €



brašna univerzálna  
320 × 350 × 170 mm 0,72 kg, kapsa 3,15l

P-71744

41,61 €



brašna s 2 kapsami  
265 × 260 × 135 mm 0,53 kg, kapsy 2,6l

P-71750

29,24 €



brašna s 3 kapsami  
325 × 315 × 175 mm 0,76 kg, kapsy 3,9l

P-71766

39,20 €





# Odkladacie systémy



Popis	objednávacie číslo	cena s DPH
brašna s 3 kapsami a opaskom 290 × 640 × 170 mm 1,4 kg, kapsy 6l	P-71772	88,51 €
brašna pre pokrývačov 270 × 265 × 155 mm 0,65 kg, kapsa 2,9l	P-71788	46,40 €
brašna na aku vŕtačku veľká 290 × 170 × 85 mm, 0,26 kg	P-71794	21,27 €
opasok 48 × 1380 mm, 0,29 kg	P-71803	19,14 €
pás s bedrovou opierkou 140 × 865 mm, 0,29 kg	P-71819	35,14 €
opasok s plastovou sponou 1340 × 50 mm, 0,23 kg	P-71825	12,21 €



# Odkladacie systémy

	popis	objednávacie číslo	cena s DPH
	puzdro na mobilný telefón 115 x 70 x 40mm, 0,06kg	P-71847	10,81 €
	držiak na kladivo 160 x 70 x 105mm, 0,23kg	P-71869	10,61 €
	brašna pre elektrikárov 160 x 155 x 50mm, 0,26kg	P-71881	18,01 €
	brašna pre tesárov 210 x 180 x 110mm, 0,28kg, kapsa 1,1l	P-71906	19,01 €
	univerzálna brašna na náradie 235 x 175 x 70mm, 0,22kg	P-71912	19,69 €
	brašna na náradie a kladivo 165 x 145 x 110mm, 0,24kg	P-71934	18,56 €



# Odkladacie systémy

	popis	objednávacie číslo	cena s DPH
	brašna na aku vítačku malá 235 × 155 × 75 mm, 0,13 kg	P-71940	14,64 €
	brašna so zipsom 185 × 180 × 115 mm 0,23 kg, kapsa 1,3l	P-71962	16,28 €
	nákolenníky gélové 210 × 165 × 90 mm, 0,49 kg	P-71978	28,27 €
	nákolenníky ľahké 210 × 175 × 50 mm, 0,18 kg	P-71984	20,44 €
	brašna na náradie 335 × 450 × 285 mm, 2,3kg	P-72001	51,92 €
	brašna s termoskou 215 × 105 × 105 mm, 0,42 kg, termoska 0,35l	P-72148	22,50 €



# Odkladacie systémy

popis	objednávacie číslo	cena s DPH
 <p>termobrašna na jedlo 230 × 280 × 170 mm, 0,36kg, 7,5l</p>	P-72023	21,27 €
 <p>batoh s organizérom 410 × 295 × 240 mm, 1,73 kg</p>	P-72017	73,74 €
 <p>brašna na náradie 185 × 515 × 170 mm, 1,51 kg, 11,3l</p>	P-72051	43,92 €
 <p>brašna na náradie 265 × 505 × 295 mm, 3,9kg, 32,9l</p>	P-72073	73,18 €
 <p>pracovná vesta 640 × 500 mm, 0,74 kg</p>	P-72089	50,29 €





# Odkladacie systémy



traky  
šírka 50 mm

P-72176

15,75 €



kožený opasok čierny veľkosť M  
1130 × 38 mm, 0,2 kg

P-72207

20,99 €



kožený opasok čierny veľkosť L  
1330 × 38 mm, 0,23 kg

P-72213

20,99 €



kožený opasok hnedý veľkosť M  
1130 × 38 mm, 0,2 kg

P-72229

20,99 €



kožený opasok hnedý veľkosť L  
1330 × 38 mm, 0,23 kg

P-72235

20,99 €



pracovné rukavice XL

P-70910

25,98 €



pracovné rukavice XXL

P-90087

24,88 €



# Odkladacie systémy



popis	objednávacie číslo	cena s DPH
<div style="text-align: center;">*****</div> ruksak na náradie s kolieskami	P-83630	92,61 €
<div style="text-align: center;">***</div> brašňa pre pokrývačov	P-81371	18,34 €
<div style="text-align: center;">***</div> univerzálna brašňa na náradie	P-81494*	13,27 €

\* do vypredania zásob

## P-74544 „Supertážká” taška na náradie LXT s kolieskami

Do tejto veľkej tašky sa vám zmestí všetko náradie a príslušenstvo potrebné pri práci, takže sa nebudete musieť viackrát vracaať po veci do auta.

Hlavné vnútorné vrecko je určené na veľké náradie. Vonkajšie vrecká na nástroje umožňujú ich rýchle vyhľadanie a vybratie. Široký zips zabezpečuje jednoduchý prístup k náradu v hlavnom vrecku. Zips má dva bežce pre pohodlné otváranie a zatváranie.

Nastaviteľný ramenný popruh umožňuje jej pohodlnejšie zdvíhanie. Kovové háčiky na koncoch vám umožnia ľahké odopnutie popruhu v prípadoch, ak ho nepotrebuje.

Pásiky okolo tašky slúžia na jej spevnenie a zaručujú jej skutočnú odolnosť a pevnosť.



objednávacie číslo

cena s DPH

P-74544

77,33 €

## P-74572 „Supertážká” taška na náradie LXT

Taška je vyrobená z polyesteru 600D a peny. Spodná časť je vyrobená z veľmi pevného polyesteru 1680 danier s polyetylénovým podkladom. Výhodou je veľmi ľahké čistenie.

Nastaviteľný ramenný popruh umožňuje jej pohodlnejšie zdvíhanie. Kovové háčiky na koncoch vám umožnia ľahké odopnutie popruhu v prípadoch, ak ho nepotrebuje.

Vrecká na stranách vystužené elastickou páskou zabraňujú vypadávaniu menších nástrojov a tým zabezpečujú ich bezpečné uloženie.

Výrazné červeno-biele logo Makita je viditeľné aj z väčšej vzdialenosti.



objednávacie číslo

cena s DPH

P-74572

43,21 €



# Systainery MAKPAC



popis (š × v × d)	objednávacie číslo	cena s DPH
systainer typ 1 295 × 105 × 395	142770-6	37,01 €
systainer typ 2 295 × 157 × 395	821550-0	32,58 €
systainer typ 3 295 × 210 × 395	821551-8	38,77 €
systainer typ 4 295 × 315 × 395	821552-6	51,69 €
vozik (rudla) na systainery (vozik je dodávaný bez kufríkov; maximálna nosnosť 125 kg)	TR00000001	172,45 €
chladiaci box typ3, objem 11L	198254-2	94,92 €
chladiaci box typ4, objem 18L	198253-4	97,45 €

# Systainery MAKPAC



popis	objednávacie číslo	cena s DPH
klip na systainer	453974-8	0,72 €
vozik pre systainery	P-83886	124,44 €
vnútro systainera na príslušenstvo /farebné/	P-83652	32,38 €
vnútro systainera so 6 odelovacími priehradkami	P-83680	14,18 €
vnútro systainera s 9 odelovacími priehradkami	P-83696	15,63 €
systainer otvorený kufrík	P-83842	70,47 €
penové vnútro	198978-0	2,96 €
adaptér systajnera k vysávaču VC4210L/M	W107418357	30,69 €

# Vnútra pre systainery

model	obj. číslo	Mak-pac typ	cena s DPH	model	obj. číslo	Mak-pac typ	cena s DPH	model	obj. číslo	Mak-pac typ	cena s DPH
1911B	837878-6		5,24 €	DBN600	839523-9		3,35 €	HR1841	839214-2		4,29 €
3706	837895-6		cena na vyžiadanie	DBO140	837809-5		7,02 €	HR2300	837651-4		4,44 €
3708	837674-2		5,12 €	DBO180	837809-5		7,02 €	HR2601	837651-4		4,44 €
3710	837674-2		5,12 €	DCS550	837628-9		4,98 €	HR2610	837914-8		4,86 €
4100KB	839436-4		3,26 €	DCS551	838269-4		5,61 €	HR2611	837914-8		4,86 €
4131	837894-8		7,91 €	DCS553	839751-6		4,09 €	HR2630	837651-4		4,44 €
4327	837803-7		2,68 €	DDA340	838040-6		5,93 €	HR2631	837914-8		4,86 €
4329	837803-7		2,68 €	DDA341	838040-6		5,93 €	HR2650	839975-4		cena na vyžiadanie
4350FCT	837803-7		2,68 €	DTD153	837670-0		6,89 €	HR2651	839975-4		cena na vyžiadanie
4351CT	837803-7		2,68 €	DTD154	837670-0		6,89 €	HR2652	839975-4		cena na vyžiadanie
4351FCT	837803-7		2,68 €	DTD155	837670-0		6,89 €	HR2653	839975-4		cena na vyžiadanie
5008MG	837657-2		6,49 €	DTD170	837670-0		6,89 €	HR2811	837868-9		4,74 €
5604	837657-2		6,49 €	DTD171	837670-0		6,89 €	HS300	837662-9		11,37 €
5704	837807-9		6,87 €	DTL060	837644-1		6,04 €	HS301	838315-3		4,38 €
6413	838030-9		5,12 €	DTL061	837644-1		6,04 €	HS6101	837807-9		6,87 €
6822	837872-8		4,95 €	DTL062	837644-1		6,04 €	HS6601	838314-5		4,38 €
6842	837876-0		4,86 €	DTL063	837644-1		6,04 €	DDA350	838040-6		5,93 €
6843	837876-0		4,86 €	DTM40	837671-8		7,78 €	DDA351	838040-6		5,93 €
6904V	837869-7		4,89 €	DTM41	837671-8		7,78 €	DDF083	837670-0		6,89 €
6906	838024-4		5,72 €	DTM50Z	837671-8		7,78 €	DDF343	837863-9		5,98 €
6952	837869-7		4,89 €	DTM51	837671-8		7,78 €	DDF441	837916-4		6,27 €
6953	837869-7		4,89 €	DTP131	837670-0		6,89 €	DDF446	837916-4		6,27 €
9046	838025-2		7,49 €	DTP141	837670-0		6,89 €	DDF448	837916-4		6,27 €
9403	837652-2		7,02 €	DTR180	839735-4		3,17 €	DDF451	837916-4		6,27 €
9404	837653-0		5,77 €	DTS130	837670-0		6,89 €	DDF453	837863-9		5,98 €
9741	838026-0		5,54 €	DTS131	837670-0		6,89 €	DDF456	837916-4		6,27 €
9902	837877-8		5,04 €	DTS141	837670-0		6,89 €	DDF458	837916-4		6,27 €
9903	837877-8		5,04 €	DTW1001	837645-9		6,99 €	DDF459	837916-4		6,27 €
9910	837658-0		2,92 €	DTW1002	837645-9		6,99 €	DDF480	837916-4		6,27 €
9911	837658-0		2,92 €	DTW181	837670-0		6,89 €	DDF481	837916-4		6,27 €
9920	837877-8		5,04 €	DTW190	838550-3		4,29 €	DDF482	837916-4		6,27 €
BCS550	837628-9		4,98 €	DTW250	837670-0		6,89 €	DDF483	837670-0		6,89 €
BHR262	837650-6		7,28 €	DTW251	837670-0		6,89 €	DDF484	837916-4		6,27 €
BO3711	838028-6		4,95 €	DTW284	837670-0		6,89 €	DDF485	837916-4		6,27 €
BO4555	838029-4		5,12 €	DTW285	837670-0		6,89 €	DF010	837871-0		4,74 €
BO4558	838029-4		5,12 €	DTW450	837645-9		6,99 €	DF012	837871-0		4,74 €
BO4565	838029-4		5,12 €	DTW800	837645-9		6,99 €	DF030	837866-3		6,02 €
BO4566	838029-4		5,12 €	FS2300	838030-9		5,12 €	DF031	838312-9		4,15 €
BO4900V	837675-0		5,65 €	FS2500	838030-9		5,12 €	DF032	838312-9		4,15 €
BO4901	837675-0		5,65 €	FS2700	838030-9		5,12 €	DF033	838312-9		4,15 €
BO5031	837874-4		5,57 €	FS4000	838030-9		5,12 €	DF330	837866-3		6,02 €
BO5041	837874-4		5,57 €	FS4300	838030-9		5,12 €	DF331	838312-9		4,15 €
BO6030	837654-8		5,44 €	FS6300	838030-9		5,12 €	DF332	838312-9		4,15 €
BO6040	837655-6		5,39 €	HP1630	838038-3		3,14 €	DF333	838312-9		4,15 €
BO6050	838246-6		4,53 €	HP1631	838038-3		3,14 €	DFR450	837631-0		5,04 €
BSS501Y	837628-9		4,98 €	HP1640	838038-3		3,14 €	DFR540	837631-0		5,04 €
BTP140Y	837670-0		6,89 €	HP1641	838038-3		3,14 €	DFR550	837631-0		5,04 €
CA5000	838390-9		9,96 €	HP2050	838039-1		6,05 €	DFS250	837805-3		6,87 €
CC300	837879-4		5,75 €	HP2051	838039-1		6,05 €	DFS251	837805-3		6,87 €
CC301	838568-4		4,47 €	HP2070	838039-1		6,05 €	DFS441	837805-3		6,87 €
DA3010	837880-9		4,95 €	HP2071	838039-1		6,05 €	DFS450	838119-3		9,30 €
DA3011	837880-9		4,95 €	HP330	837866-3		6,02 €	DFS451	837805-3		6,87 €
DA330	837695-4		6,58 €	HP331	838312-9		4,15 €	DGA452	837632-8		5,07 €
DA331	837695-4		6,58 €	HP332	838312-9		4,15 €	DGA504	838175-3		4,22 €
DA332	839304-1		4,29 €	HP333	838312-9		4,15 €	DGA505	838175-3		4,22 €
DA333	839304-1		4,29 €	HR140	839245-1		4,15 €	DGA506	838175-3		4,22 €
DBN500	838023-6		4,89 €	HR166	839245-1		4,15 €	DGA508	838175-3		4,22 €



# Vnútra pre systainery

model	obj. číslo	Mak-pac typ	cena s DPH	model	obj. číslo	Mak-pac typ	cena s DPH	model	obj. číslo	Mak-pac typ	cena s DPH
DGA511	839252-4		3,29 €	SG1251	838111-9		4,77 €	DP4700	837872-8		4,95 €
DGA513	839252-4		3,29 €	SP6000	838390-9		9,96 €	DPJ140	837648-3		6,63 €
DGA514	839822-9		cena na vyžiadanie	ST113	839019-0		4,86 €	DPJ180	837648-3		6,63 €
DGA517	839252-4		3,29 €	TD021	837871-0		4,74 €	DPT350	837640-9		7,44 €
DGD800	837806-1		7,31 €	TD022	837871-0		4,74 €	DPT351	837640-9		7,44 €
DHP343	837863-9		5,98 €	TD090	837866-3		6,02 €	DPT353	839128-5		6,40 €
DHP446	837916-4		6,27 €	TD110	838312-9		4,15 €	DRT50	837247-1		5,94 €
DHP448	837916-4		6,27 €	TD111	838312-9		4,15 €	DS4012	838181-8		6,34 €
DHP451	837916-4		6,27 €	TL064	839287-5		4,65 €	DSC102	839527-1		3,20 €
DHP453	837916-4		6,27 €	TL065	839287-5		4,65 €	DSP600	839290-6		3,76 €
DHP454	837916-4		6,27 €	TM3000	837673-4		6,57 €	DSP601	839290-6		3,76 €
DHP456	837916-4		6,27 €	TM3010	837773-0		5,12 €	DSS500	837628-9		4,98 €
DHP458	837916-4		6,27 €	TM30	838612-7		5,04 €	DSS501	837628-9		4,98 €
DHP459	837916-4		6,27 €	TW0200	837869-7		4,89 €	DSS610	837642-5		6,44 €
DHP470	837916-4		6,27 €	TW0350	837870-2		4,80 €	DST110	837640-9		7,44 €
DHP480	837916-4		6,27 €	TW100	837866-3		6,02 €	DST111	838582-0		5,30 €
DHP481	837916-4		6,27 €	TW140	838312-9		4,15 €	DST112	838582-0		5,30 €
DHP482	837916-4		6,27 €	DHR171	839387-1		4,36 €	DST220	837640-9		7,44 €
DHP483	837670-0		6,89 €	DHR182	839891-0		4,00 €	DST221	837640-9		7,44 €
DHP484	837916-4		6,27 €	DHR202	837634-4		5,04 €	DTD129	837670-0		6,89 €
DHP485	837916-4		6,27 €	DHR241	837641-7		6,75 €	DTD134	837670-0		6,89 €
DHR164	838109-6		5,12 €	DHR242	837649-1		5,18 €	DTD137	837670-0		6,89 €
DHR164	838109-6		5,12 €	DHR243	837649-1		5,18 €	DTD146	837670-0		6,89 €
DHR165	838109-6		5,12 €	DHR263	837988-9		5,45 €	DTD148	837670-0		6,89 €
HS7101	837807-9		6,87 €	DHR264	837988-9		5,45 €	DTD152	837670-0		6,89 €
HS7601	838108-8		10,73 €	DHR280	839559-8		3,35 €				
JN1601	837882-5		5,12 €	DHR280	835A32-2		3,23 €				
JN3201	837630-2		6,34 €	DHR281	839559-8		3,35 €				
JR1000	837881-7		7,08 €	DHR282	839559-8		3,35 €				
JR100	837664-5		5,33 €	DHR283	839559-8		3,35 €				
JR102	837664-5		5,33 €	DHS630	837635-2		10,53 €				
JR103	838313-7		6,04 €	DHS660	839752-4		3,23 €				
JR105	838313-7		6,04 €	DHS661	839752-4		3,23 €				
JS1000	838027-8		5,45 €	DHS680	838182-6		5,10 €				
JS1601	838027-8		5,45 €	DHS710	837861-3		18,21 €				
JS1602	837882-5		5,12 €	DJN160	837678-4		6,34 €				
JS3201	837630-2		6,34 €	DJN161	837678-4		6,34 €				
JV0600	837803-7		2,68 €	DJR183	837897-2		4,89 €				
JV100	837665-3		6,31 €	DJR185	837897-2		4,89 €				
JV101	838563-4		4,53 €	DJR188	839458-4		3,32 €				
JV102	839186-1		4,15 €	DJS101	837636-0		7,35 €				
JV103	839186-1		4,15 €	DJS130	838302-2		6,31 €				
KP0800	837659-8		7,09 €	DJS160	837636-0		7,35 €				
KP0810	837659-8		7,09 €	DJS161	837636-0		7,35 €				
MEU029	837803-7		2,68 €	DJV140	837639-4		6,68 €				
MEU029	838390-9		9,96 €	DJV141	837789-5		6,30 €				
N1923B	837878-6		5,24 €	DJV142	837639-4		6,68 €				
N5900B	837873-6		5,06 €	DJV180	837639-4		6,68 €				
PJ7000	837661-1		8,62 €	DJV181	837789-5		6,30 €				
PT354	839166-7		5,66 €	DJV182	837639-4		6,68 €				
RP0900	837646-7		4,86 €	DKP180	837808-7		6,63 €				
RP0910	837660-3		5,66 €	DP2010	838030-9		5,12 €				
RP1110	837660-3		5,66 €	DP2011	838030-9		5,12 €				
RP1800	837647-5		5,92 €	DP3003	838039-1		6,05 €				
RP2300	837647-5		5,92 €	DP4001	838039-1		6,05 €				
RT0700	837247-1		5,94 €	DP4003	838039-1		6,05 €				
SD100	839016-6		4,47 €	DP4011	838039-1		6,05 €				

# Prepravné kufre

model	obj. číslo	materiál	cena s DPH
1806B	821137-8	H	125,90 €
2107FK	824728-4	K	42,38 €
4112HS	824697-9	K	73,02 €
4304	824809-4	K	20,56 €
4304T	824809-4	K	20,56 €
4305	824809-4	K	20,56 €
4305T	824809-4	K	20,56 €
4326	824572-9	M	13,46 €
4327	824572-9	M	13,46 €
4329	824572-9	M	13,46 €
4331DWD	824553-3	K	27,15 €
4334DWD	824553-3	K	27,15 €
4350CT/FCT	824809-4	K	20,56 €
4351CT/FCT	824809-4	K	20,56 €
4604DW	824556-7	K	46,62 €
5017RKB	193196-5	K	54,94 €
5603R	824555-9	K	38,43 €
5604R	824555-9	K	38,43 €
5621RDWA	824533-9	K	57,25 €
5703RK	824554-1	K	37,80 €
5704R	824555-9	K	38,43 €
5705RK	824554-1	K	37,80 €
5903R	193196-5	K	54,94 €
6016DW	824723-4	K	16,93 €
6017D	824723-4	K	16,93 €
6018D	824723-4	K	16,93 €
6019D	824723-4	K	16,93 €
6095D	824723-4	K	16,93 €
6096D	824723-4	K	16,93 €
6203D	824476-5	K	22,59 €
6204D	824635-1	K	12,74 €
6207D	183763-4	K	19,55 €
6213D	824476-5	K	22,59 €
6214D	824635-1	K	12,74 €
6216D	824525-8	K	34,96 €
6226D	824635-1	K	12,74 €
6227D	824635-1	K	12,74 €
6228D	824635-1	K	12,74 €
6261D	824635-1	K	12,74 €
6271D	824852-3	K	16,22 €
6281D	824635-1	K	12,74 €
6313D	824476-5	K	22,59 €
6314D	824635-1	K	12,74 €
6315D	824525-8	K	34,96 €
6316D	824525-8	K	34,96 €
6317D	183763-4	K	19,55 €
6319D	824626-2	K	25,86 €
6327D	824635-1	K	12,74 €
6328D	824635-1	K	12,74 €
6333D	824476-5	K	22,59 €
6336D	824525-8	K	34,96 €

model	obj. číslo	materiál	cena s DPH
6337D	183763-4	K	19,55 €
6339D	824626-2	K	25,86 €
6343D	824525-8	K	34,96 €
6347D	183763-4	K	19,55 €
6349D	824626-2	K	25,86 €
6381D	824852-3	K	16,22 €
6390	824744-6	K	12,31 €
6391D	824852-3	K	16,22 €
6503D	824635-1	K	12,74 €
6704D	824380-8	K	58,19 €
6824	824449-8	K	9,76 €
6825R	824449-8	K	9,76 €
6826	824449-8	K	9,76 €
6827	824449-8	K	9,76 €
6830	824421-0	K	49,61 €
6831D	824551-7	K	27,95 €
6832	824421-0	K	49,61 €
6833	824421-0	K	49,61 €
6834	824421-0	K	49,61 €
6835D	824551-7	K	27,95 €
6842	824808-6	K	34,72 €
6844	824808-6	K	34,72 €
6904VH	824439-1	K	26,90 €
6906	182604-1	M	100,92 €
6908D	824635-1	K	12,74 €
6914D	824635-1	K	12,74 €
6915D	824549-4	K	21,56 €
6916D	824635-1	K	12,74 €
6918D	824635-1	K	12,74 €
6934FD	824635-1	K	12,74 €
6940D	824686-4	K	46,90 €
6951	824439-1	K	26,90 €
6960D	824635-1	K	12,74 €
8271D	824635-1	K	12,74 €
8281D	824635-1	K	12,74 €
8391D	824581-8	K	12,14 €
8413D	824626-2	K	25,86 €
8414D	824626-2	K	25,86 €
8433D	824626-2	K	25,86 €
8434D	824626-2	K	25,86 €
8443D	824626-2	K	25,86 €
8444D	824626-2	K	25,86 €
9554NB	824736-5	K	12,48 €
9555NB	824736-5	K	12,48 €
9557H/R	188627-7	M	25,30 €
9558H/R	188627-7	M	25,30 €
AF505	HY00000090	K	13,81 €
AN450H	824792-5	K	39,76 €
AN510H	824793-3	K	39,63 €

K – plast; M – železo; H – drevo; T – taška



## Prepravné kufre

model	obj. číslo	materiál	cena s DPH
AN610H	824490-1	K	27,36 €
AN620H	824490-1	K	27,36 €
AN621	824582-6	K	26,68 €
AN711H	824792-5	K	39,76 €
AN901	824545-2	K	49,43 €
AN911H	824792-5	K	39,76 €
AT638	A0905-0361	K	8,90 €
BBO180	821533-0	K	42,96 €
BCS550	141485-2	K	21,53 €
BDA340	141358-9	K	39,12 €
BDA341	141358-9	K	39,12 €
BDF343	158777-2	K	25,75 €
BDF440	141205-4	K	25,56 €
BDF441	140354-4	K	33,09 €
BDF442	158597-4	K	18,98 €
BDF444	140354-4	K	33,09 €
BDF446	141856-3	K	20,60 €
BDF450	141205-4	K	25,56 €
BDF451	140354-4	K	33,09 €
BDF452	158597-4	K	18,98 €
BDF453	158777-2	K	25,75 €
BDF454	140354-4	K	33,09 €
BDF456	141856-3	K	20,60 €
BDF459	158597-4	K	18,98 €
BDF460	824567-2	K	39,98 €
BFR440	140392-6	K	29,11 €
BFR540	824807-8	K	36,62 €
BFR550	824807-8	K	36,62 €
BFR750	824807-8	K	36,62 €
BFS451	824978-1	K	37,67 €
BGA450	141257-5	K	23,36 €
BGA452	141257-5	K	23,36 €
BGD800	824975-7	K	21,06 €
BHP343	158777-2	K	25,75 €
BHP440	141205-4	K	25,56 €
BHP441	140354-4	K	33,09 €
BHP442	158597-4	K	18,98 €
BHP444	140354-4	K	33,09 €
BHP446	141856-3	K	20,60 €
BHP450	141205-4	K	25,56 €
BHP451	140354-4	K	33,09 €
BHP452	158597-4	K	18,98 €
BHP453	158777-2	K	25,75 €
BHP454	140354-4	K	33,09 €
BHP456	141856-3	K	20,60 €
BHP459	158597-4	K	18,98 €
BHP460	824567-2	K	39,98 €
BHR162	141074-3	K	29,04 €
BHR200	824690-3	K	36,46 €
BHR202	141642-2	K	25,29 €
BHR240	141643-0	K	28,32 €

model	obj. číslo	materiál	cena s DPH
BHR241	141643-0	K	28,32 €
BHR243	141401-4	K	32,56 €
BHR261	142551-8	K	71,40 €
BHR262	142551-8	K	71,40 €
BHS630	824995-1	K	61,14 €
BJR181	141354-7	K	26,19 €
BJS101	141478-9	K	41,43 €
BJS130	140392-6	K	29,11 €
BJV140	141486-0	K	30,02 €
BJV180	141486-0	K	30,02 €
BKP180	824982-0	K	39,75 €
BO4555	824806-0	K	13,81 €
BO4557	824806-0	K	13,81 €
BO4565	824806-0	K	13,81 €
BO6040	824591-5	K	25,61 €
BPB180	141496-7	K	86,00 €
BPJ180	141533-7	K	55,81 €
BPT350	141074-3	K	29,04 €
BPT351	141932-3	K	84,83 €
BSR730	153612-9	K	57,35 €
BSS500	141485-2	K	21,53 €
BSS610	824757-7	K	20,59 €
BTD130	141205-4	K	25,56 €
BTD132	141205-4	K	25,56 €
BTD133	141205-4	K	25,56 €
BTD134	824979-9	K	26,98 €
BTD136	824979-9	K	26,98 €
BTD140	141205-4	K	25,56 €
BTD146	824979-9	K	26,98 €
BTD147	824979-9	K	26,98 €
BTD200	824593-1	K	44,46 €
BTL060	141493-3	K	38,22 €
BTL061	141493-3	K	38,22 €
BTM50	141562-0	K	27,14 €
BTP130	141205-4	K	25,56 €
BTP140	141205-4	K	25,56 €
BTP141	824979-9	K	26,98 €
BTS130	141205-4	K	25,56 €
BTW251	141205-4	K	25,56 €
BTW450	141644-8	K	56,11 €
BUC122	141494-1	K	61,40 €
BVR450	141481-0	K	40,44 €
DA312D	824627-0	K	19,56 €
DA330D	821556-8	K	18,33 €
DA391D	824627-0	K	19,56 €
DA392D	824627-0	K	19,56 €
DA4000LR	824646-6	K	39,26 €
DBM080	P-45135	M	cena na vyžiadanie
DBM130	P-45141	M	59,18 €

K – plast; M – železo; H – drevo; T – taška

# Prepravné kufre

model	obj. číslo	materiál	cena s DPH
DDF482	141856-3	K	20,60 €
DF010DSE	824781-0	K	2,61 €
DF030D	824842-6	K	14,93 €
DF031D	821661-1	K	12,37 €
DF330D	824842-6	K	14,93 €
DF331D	821661-1	K	12,37 €
DF347D	824981-2	K	21,02 €
DF457D	824981-2	K	21,02 €
DGA900/901	821717-0	K	49,58 €
DHP482	141856-3	K	20,60 €
DHR263	142551-8	K	71,40 €
DHR264	142551-8	K	71,40 €
DHR400	821746-3	K	46,32 €
DJR181	141354-7	K	26,19 €
DJR186	821620-5	K	24,38 €
DJR187	821620-5	K	24,38 €
DJR360	821670-0	K	41,08 €
DP3003	824595-7	K	26,88 €
DP4001	824595-7	K	26,88 €
DP4003	824595-7	K	26,88 €
DPB181RFE	831303-9	T	21,38 €
DSC191RF	SC09009190	K	233,83 €
DTD152	141856-3	K	20,60 €
DTS141RFE	824979-9	K	26,98 €
DUC122	141494-1	K	61,40 €
DVR450	141481-0	K	40,44 €
FS2700	824890-5	K	16,21 €
GA9020	824958-7	K	35,00 €
GN420CSE	821512-8	K	63,61 €
HB500	CASE14	K	239,91 €
HG5002K	HG130442	K	13,58 €
HG5012K	HG130442	K	13,58 €
HG550VK	HG130442	K	13,58 €
HG551VK	HG130442	K	13,58 €
HG650CK	HG130442	K	13,58 €
HG651CK	HG130442	K	13,58 €
HK0500	824523-2	K	41,51 €
HK1810	150640-5	K	33,72 €
HK1820	824789-4	K	17,56 €
HM0810B	150878-2	K	87,09 €
HM0860C	824708-0	K	50,33 €
HM0870C	824905-8	K	49,51 €
HM0871C	824905-8	K	49,51 €
HM1100	150676-4	K	69,75 €
HM1100C	150676-4	K	69,75 €
HM1101C	140562-7	K	122,41 €
HM1111C	140562-7	K	122,41 €
HM1130C	150676-4	K	69,75 €
HM1140C	150676-4	K	69,75 €
HM1200	150583-1	K	45,17 €
HM1200B	150586-5	K	52,21 €

model	obj. číslo	materiál	cena s DPH
HM1202C	824564-8	K	72,78 €
HM1203C	824876-9	K	137,16 €
HM1205C	824876-9	K	137,16 €
HM1213C	824908-2	K	95,31 €
HM1214C	824882-4	K	163,30 €
HM1303	182852-2	M	162,11 €
HM1303B	182852-2	M	162,11 €
HM1304	183567-4	M	138,56 €
HM1304B	824826-4	M	89,83 €
HM1307C	824898-9	K	168,30 €
HM1307CB	824898-9	K	168,30 €
HM1317C	824898-9	K	168,30 €
HP1620K	824923-6	K	21,09 €
HP1621K	824923-6	K	21,09 €
HP1630K	824811-7	K	23,26 €
HP1631K	824811-7	K	23,26 €
HP1640K	824923-6	K	21,09 €
HP1641K	824923-6	K	21,09 €
HP2040	824449-8	K	9,76 €
HP2041	824449-8	K	9,76 €
HP2050	824650-5	K	15,74 €
HP2051	824650-5	K	15,74 €
HP2070	824650-5	K	15,74 €
HP2071	824650-5	K	15,74 €
HP330D	821525-9	K	11,97 €
HP331	821661-1	K	12,37 €
HP457DWE	824981-2	K	21,02 €
HR1830	824650-5	K	15,74 €
HR2010	824464-2	K	29,85 €
HR2020	824650-5	K	15,74 €
HR2230	824799-1	K	15,34 €
HR2300	824914-7	K	20,63 €
HR2400	824445-6	K	25,70 €
HR2410	824445-6	K	25,70 €
HR2432	824729-2	K	32,55 €
HR2440	824650-5	K	15,74 €
HR2450	824650-5	K	15,74 €
HR2450T	824695-3	K	14,96 €
HR2460	824799-1	K	15,34 €
HR2470	824799-1	K	15,34 €
HR2470T	824799-1	K	15,34 €
HR2600	824914-7	K	20,63 €
HR2610	140402-9	K	20,29 €
HR2610T	140404-5	K	26,83 €
HR2611F	140401-1	K	21,24 €
HR2611FT	140403-7	K	27,13 €
HR2630	824914-7	K	20,63 €
HR2630T	824914-7	K	20,63 €
HR2631F	824914-7	K	20,63 €

K – plast; M – železo; H – drevo; T – taška

# Prepravné kufre

model	obj. číslo	materiál	cena s DPH
HR2631FT	824914-7	K	20,63 €
HR2641	824695-3	K	14,96 €
HR2800	824789-4	K	17,56 €
HR2810	824789-4	K	17,56 €
HR2810T	824789-4	K	17,56 €
HR2811F	824789-4	K	17,56 €
HR2811FT	824789-4	K	17,56 €
HR3000C	824559-1	K	59,49 €
HR3200C	824825-6	K	61,53 €
HR3210C	824825-6	K	61,53 €
HR3210FCT	824825-6	K	61,53 €
HR3520	150597-0	K	51,84 €
HR3540C	824825-6	K	61,53 €
HR3550C	824559-1	K	59,49 €
HR4000C	824479-9	K	67,53 €
HR4001C	196183-3	K	104,11 €
HR4002	824798-3	K	38,84 €
HR4003C	196531-6	K	173,87 €
HR4010C	196183-3	K	104,11 €
HR4011C	196183-3	K	104,11 €
HR4013C	196531-6	K	173,87 €
HR4500C	824607-6	K	64,52 €
HR4501C	158275-6	K	87,15 €
HR4510C	158275-6	K	87,15 €
HR4511C	158273-0	K	91,41 €
HR5001C	824519-3	K	75,92 €
HR5201C	158275-6	K	87,15 €
HR5202C	196552-8	K	178,88 €
HR5210C	158275-6	K	87,15 €
HR5211C	158273-0	K	91,41 €
HR5212C	196552-8	K	178,88 €
HS300D	824961-8	K	21,00 €
HS301D	821663-7	K	20,83 €
HS7101	141736-3	K	64,86 €
JR1000FTK	824722-6	K	21,18 €
JR100DWE	824993-5	K	17,98 €
JR103D	821662-9	K	29,35 €
JR180DWD	824565-6	K	45,69 €

model	obj. číslo	materiál	cena s DPH
JR3000V	824539-7	K	10,35 €
JR3000VT	824539-7	K	10,35 €
JR3020	824539-7	K	10,35 €
JR3030	824539-7	K	10,35 €
JR3030T	824539-7	K	10,35 €
JR3050T	821621-3	K	22,11 €
JR3060T	821621-3	K	22,11 €
JR3070CT	821621-3	K	22,11 €
JV0600K	824998-5	K	19,37 €
JV100DWE	821508-9	K	19,46 €
JV183DWE	821646-7	K	21,46 €
KP0800	824892-1	K	17,52 €
KP0810	824786-0	K	42,98 €
KP0810C	824786-0	K	42,98 €
N1923B	P-72366	K	68,48 €
NHP1300S	824700-6	K	24,40 €
PC1100	181789-0	M	79,87 €
PC5000C	140073-2	M	98,44 €
PC5001C	140073-2	M	98,44 €
PJ7000	821509-7	K	25,82 €
RT0700C/CX2	831327-5	T	43,29 €
SC130DRA	SC08100910	K	173,23 €
SG1250	824709-8	K	43,14 €
SG1251	821552-6	K	51,69 €
SG150	B50856	M	91,85 €
SG180	B06337	M	116,95 €
SP6000K	821552-6	K	51,69 €
TD020DSE	831276-6	T	14,19 €
TD021DSE	831276-6	T	14,19 €
TD090D	824842-6	K	14,93 €
TD091D	141740-2	K	13,24 €
TD110D	821661-1	K	12,37 €
TM3000C	821596-6	K	18,96 €
TW0200	824703-0	K	14,39 €
TW0350	824702-2	K	23,34 €
TW1000	824737-3	K	59,19 €
VR250D	824486-2	K	20,14 €

	model	obj. číslo	materiál	cena s DPH
	Univerzálny kufror vnútorný rozmer (HxBxT) 275 × 410 × 260 (mm)	824964-2	K	48,05 €
	Univerzálny kufror vnútorný rozmer (HxBxT) 92 × 450 × 250 (mm)	P-04101	M	47,52 €
	Kufrík pre uhlové brúsky 125 mm	188627-7	M	25,30 €

	model	obj. číslo	materiál	cena s DPH
	Raaco kufrík	P-78623	K	88,03 €
	Prepravná taška	831279-0	T	68,90 €
	Kufror kombinovaný pre uhlové brúsky s ø230mm a ø125mm	824984-6	K	52,06 €

K – plast; M – železo; H – drevo; T – taška

# Spony pre prepravné kufre

Model	kufor	spona	cena s DPH
1050DWA	824544-4	<b>417059-4</b>	0,20 €
1806B	821137-8		
1902	182113-0		
1923H	182113-0		
2012NB	824002-0		
2107FK	824728-4	<b>163455-1</b>	0,92 €
3612/C	P-38314		
3620	P-38314		
3901	824540-2	<b>417059-4</b>	0,20 €
4112HS	824697-9	<b>163467-4</b>	1,32 €
4304	824809-4	<b>183091-7</b>	1,73 €
4304T	824809-4	<b>183091-7</b>	1,73 €
4305	824809-4	<b>183091-7</b>	1,73 €
4305T	824809-4	<b>183091-7</b>	1,73 €
4326	824572-9	<b>186347-7</b>	1,31 €
4327	824572-9	<b>186347-7</b>	1,31 €
4329	824572-9	<b>186347-7</b>	1,31 €
4331DWD	824553-3	<b>416661-0</b>	1,29 €
4334DWD	824553-3	<b>416661-0</b>	1,29 €
4350CT/FCT	824809-4	<b>183091-7</b>	1,73 €
4351CT/FCT	824809-4	<b>183091-7</b>	1,73 €
4604DW	824556-7	<b>416401-6</b>	2,23 €
5017RKB	193196-5	<b>183336-3</b>	1,41 €
5103R	P-15942		
5603R	824606-8	<b>183336-3</b>	1,41 €
5604R	824555-9		
5621RDWA	824533-9	<b>417075-6</b>	6,49 €
5703RK	824606-8	<b>183336-3</b>	1,41 €
5704R	824555-9		
5705RK	824606-8	<b>183336-3</b>	1,41 €
5903R	193196-5	<b>183336-3</b>	1,41 €
6016DW	824723-4	<b>183091-7</b>	1,73 €
6017DWE	824723-4	<b>183091-7</b>	1,73 €
6018DWE	824723-4	<b>183091-7</b>	1,73 €
6019DWE	824723-4	<b>183091-7</b>	1,73 €
6019DWE	824723-4	<b>183091-7</b>	1,73 €
6095DWE	824723-4	<b>183091-7</b>	1,73 €
6095DWE	824723-4	<b>183091-7</b>	1,73 €
6096DWE	824723-4	<b>183091-7</b>	1,73 €
6096DWE	824723-4	<b>183091-7</b>	1,73 €
6203DWAE	824476-5	<b>416661-0</b>	1,29 €
6203DWBE	824476-5	<b>416661-0</b>	1,29 €
6204DWAE	824653-1	<b>186347-7</b>	1,31 €
6207DWDE	183763-4	<b>417724-5</b>	0,35 €
6213DWAE	824476-5	<b>416661-0</b>	1,29 €
6213DWBE	824476-5	<b>416661-0</b>	1,29 €
6214DWAE	824635-1	<b>186347-7</b>	1,31 €
6216DWAE	824525-8	<b>417075-6</b>	6,49 €
6216DWBE	824525-8	<b>417075-6</b>	6,49 €
6221DWE	824715-3	<b>186347-7</b>	1,31 €

Model	kufor	spona	cena s DPH
6222DWE	824715-3	<b>186347-7</b>	1,31 €
6223DWE	824510-1	<b>186347-7</b>	1,31 €
6226DWE	824635-1	<b>186347-7</b>	1,31 €
6227DWE	824635-1	<b>186347-7</b>	1,31 €
6228DWE	824635-1	<b>186347-7</b>	1,31 €
6261DWE	824853-1	<b>163455-1</b>	0,92 €
6261DWLE	824853-1	<b>163455-1</b>	0,92 €
6271DWAE	824853-1	<b>163455-1</b>	0,92 €
6271DWALE	824581-8		
6271DWPE	824853-1	<b>163455-1</b>	0,92 €
6281DWAE	824853-1	<b>163455-1</b>	0,92 €
6281DWALE	824581-8		
6313DWAE	824476-5	<b>416661-0</b>	1,29 €
6313DWBE	824476-5	<b>416661-0</b>	1,29 €
6314DWAE	824635-1	<b>186347-7</b>	1,31 €
6316DWAE	824525-8	<b>417075-6</b>	6,49 €
6316DWBE	824525-8	<b>417075-6</b>	6,49 €
6317DWDRE	183763-4	<b>417724-5</b>	0,35 €
6319DWFE	824626-2	<b>450909-0</b>	0,26 €
6327DWE	824635-1	<b>186347-7</b>	1,31 €
6328DWE	824635-1	<b>186347-7</b>	1,31 €
6333DWAE	824476-5	<b>416661-0</b>	1,29 €
6333DWBE	824476-5	<b>416661-0</b>	1,29 €
6336DWAE	824525-8	<b>417075-6</b>	6,49 €
6336DWBE	824525-8	<b>417075-6</b>	6,49 €
6337DWDESP	183763-4	<b>417724-5</b>	0,35 €
6339DWFE	824626-2	<b>450909-0</b>	0,26 €
6343DWAE	824525-8	<b>417075-6</b>	6,49 €
6343DWBE	824525-8	<b>417075-6</b>	6,49 €
6347DWDESP	183763-4	<b>417724-5</b>	0,35 €
6349DWFE	824626-2	<b>450909-0</b>	0,26 €
6380	824744-6		
6381DWAE	824852-3	<b>163455-1</b>	0,92 €
6390	824744-6		
6391DWAE	824853-1	<b>163455-1</b>	0,92 €
6391DWALE	824853-1	<b>163455-1</b>	0,92 €
6503DWDE	824635-1	<b>186347-7</b>	1,31 €
6704DW	824380-8	<b>182935-8</b>	2,64 €
6800DBV	824700-6		
6802DBV	824700-6		
6805DBV	824700-6		
6822	824700-6		
6824	824449-8	<b>182935-8</b>	2,64 €
6825R	824449-8	<b>182935-8</b>	2,64 €
6826	824449-8	<b>182935-8</b>	2,64 €
6827	824449-8	<b>182935-8</b>	2,64 €
6830	824421-0	<b>182935-8</b>	2,64 €
6831DWH	824551-7	<b>417075-6</b>	6,49 €
6832	824421-0	<b>182935-8</b>	2,64 €
6833	824421-0	<b>182935-8</b>	2,64 €

## Spony pre prepravné kufre

Model	kufor	spona	cena s DPH
6834	824421-0	<b>182935-8</b>	2,64 €
6835DWH	824551-7	<b>417075-6</b>	6,49 €
6842	824808-6	<b>163455-1</b>	0,92 €
6844	824808-6	<b>163455-1</b>	0,92 €
6904VH	824439-1	<b>182935-8</b>	2,64 €
6905B	824698-7	<b>182935-8</b>	2,64 €
6905H	824698-7	<b>182935-8</b>	2,64 €
6906	182604-1		
6908DWA	824635-1	<b>186347-7</b>	1,31 €
6914DWA	824635-1	<b>186347-7</b>	1,31 €
6915DWA	824549-4	<b>186347-7</b>	1,31 €
6916DWA	824635-1	<b>186347-7</b>	1,31 €
6918DWA	824635-1	<b>186347-7</b>	1,31 €
6918FDWDE	824635-1	<b>186347-7</b>	1,31 €
6934FDWDE	824635-1	<b>186347-7</b>	1,31 €
6935FDWDE	824635-1	<b>186347-7</b>	1,31 €
6936FDWDE	154902-3		
6940DW	824686-4	<b>182935-8</b>	2,64 €
6951	824439-1	<b>182935-8</b>	2,64 €
6953	824630-1	<b>186347-7</b>	1,31 €
6960DWA	824635-1	<b>186347-7</b>	1,31 €
6980FDWDE	824710-3	<b>417724-5</b>	0,35 €
8271DWAE	824853-1	<b>163455-1</b>	0,92 €
8281DWAE	824853-1	<b>163455-1</b>	0,92 €
8281DWAET2	149504-3		
8281DWALE	824853-1	<b>163455-1</b>	0,92 €
8381DWAE	824852-3	<b>163455-1</b>	0,92 €
8391DWAE	824853-1	<b>163455-1</b>	0,92 €
8391DWALE	824853-1	<b>163455-1</b>	0,92 €
8413DWDE	824626-2	<b>450909-0</b>	0,26 €
8414DWFE	824626-2	<b>450909-0</b>	0,26 €
8433DWDE	824626-2	<b>450909-0</b>	0,26 €
8434DWFE	824626-2	<b>450909-0</b>	0,26 €
8443DWDE	824626-2	<b>450909-0</b>	0,26 €
8444DWFE	824626-2	<b>419655-4</b>	0,23 €
9554NB	824736-5		
9555NB	824736-5		
9557HN	188627-7		
9558HNK	188627-7		
9562CH/CVH	188627-7		
9564H	188627-7		
9565CR/CVR	188627-7		
9565CLR	188627-7		
9565H	188627-7		
9566CR/CVR	188627-7		
AF505	HY00000090		
AN450H	824792-5		
AN510H	824793-3		
AN610H	824490-1		
AN620H	824490-1		

Model	kufor	spona	cena s DPH
AN621	824582-6		
AN711H	824792-5		
AN901	824545-2	<b>417075-6</b>	6,49 €
AN911H	824792-5		
AN943K	824841-8		
BCS550RFE	824802-8	<b>163455-1</b>	0,92 €
BDA340RFE	824851-5	<b>163455-1</b>	0,92 €
BDA341RFE	824851-5	<b>163455-1</b>	0,92 €
BDA350Z	824816-7	<b>163455-1</b>	0,92 €
BDA351Z	824816-7	<b>163455-1</b>	0,92 €
BDF343SHE	824862-0	<b>163455-1</b>	0,92 €
BDF430F	824710-3	<b>417724-5</b>	0,35 €
BDF440RFE	824753-5	<b>417724-5</b>	0,35 €
BDF441RFE	824754-3	<b>417724-5</b>	0,35 €
BDF442RFE	824774-7	<b>417724-5</b>	0,35 €
BDF450RFE	824753-5	<b>417724-5</b>	0,35 €
BDF451RFE	824754-3	<b>417724-5</b>	0,35 €
BDF452RFE	824774-7	<b>417724-5</b>	0,35 €
BDF453SHE	824862-0	<b>163455-1</b>	0,92 €
BDF460SH	153514-9	<b>417075-6</b>	6,49 €
BFR440RFE	824756-9	<b>417059-4</b>	0,20 €
BFR540RFE	824807-8	<b>163455-1</b>	0,92 €
BFR550RFE	824807-8	<b>163455-1</b>	0,92 €
BFR750RFE	824807-8	<b>163455-1</b>	0,92 €
BFS230F	824710-3	<b>417724-5</b>	0,35 €
BFS440Z	824756-9	<b>417724-5</b>	0,35 €
BFS450Z	824756-9	<b>417724-5</b>	0,35 €
BGA450RFE	824767-4	<b>163455-1</b>	0,92 €
BGA452RFE	824767-4	<b>163455-1</b>	0,92 €
BHP343SHE	824862-0	<b>163455-1</b>	0,92 €
BHP440RFE	824753-5	<b>417724-5</b>	0,35 €
BHP441RFE	824754-3	<b>417724-5</b>	0,35 €
BHP442RFE	824774-7	<b>417724-5</b>	0,35 €
BHP450RFE	824753-5	<b>417724-5</b>	0,35 €
BHP451RFE	824754-3	<b>417724-5</b>	0,35 €
BHP452RFE	824774-7	<b>417724-5</b>	0,35 €
BHP453SHE	824862-0	<b>163455-1</b>	0,92 €
BDF / BHP456	141856-3	<b>162302-3</b>	0,77 €
BHP460SH	153514-9	<b>417075-6</b>	6,49 €
BHR162RFE	824815-9	<b>417724-5</b>	0,35 €
BHR200SF	824690-3	<b>417152-4</b>	1,07 €
BHR200SJE	824690-3	<b>417152-4</b>	1,07 €
BHR202RFE	824861-2	<b>163455-1</b>	0,92 €
BHR240	824771-3	<b>163455-1</b>	0,92 €
BHR241RFE	824771-3	<b>163455-1</b>	0,92 €
BHR261RDE/ TRDE	824874-3	<b>162271-8</b>	1,47 €
BJR181RFE	824760-8	<b>163455-1</b>	0,92 €
BJS101RFE	824899-7	<b>163455-1</b>	0,92 €
BJS130RFE	824756-9	<b>417059-4</b>	0,20 €

# Spony pre prepravné kufre

Model	kufor	spona	cena s DPH
BJV140RFE	824775-5	<b>450909-0</b>	0,26 €
BJV180RFE	824775-5	<b>450909-0</b>	0,26 €
BO4555/4556	824806-0		
BO4557	824806-0		
BO4565/4566	824806-0		
BO5030	824562-2		
BO5031	824562-2		
BO6040	824591-5	<b>417059-4</b>	0,20 €
BPB180RFE	824766-6	<b>163467-4</b>	1,32 €
BPT350RFE	824863-8		
BSR730SH	153612-9	<b>417075-6</b>	6,49 €
BSS500RFE	824802-8		
BSS610RFE	824757-7	<b>163455-1</b>	0,92 €
BTD123F	824710-3	<b>417724-5</b>	0,35 €
BTD130FRFE	824753-5	<b>417724-5</b>	0,35 €
BTD132RFE	140058-8	<b>417724-5</b>	0,35 €
BTD133RFE	140058-8	<b>417724-5</b>	0,35 €
BTD140RFE	824753-5	<b>417724-5</b>	0,35 €
BTD200SH	824593-1	<b>417075-6</b>	6,49 €
BTL060RFE	824816-7	<b>163455-1</b>	0,92 €
BTL061RFE	824816-7	<b>163455-1</b>	0,92 €
BTP130RFE	824753-5	<b>417724-5</b>	0,35 €
BTP140RFE	824753-5	<b>417724-5</b>	0,35 €
BTW200SH	824593-1	<b>417075-6</b>	6,49 €
BTW250RFE	824753-5	<b>417724-5</b>	0,35 €
BTW251RFE	824753-5	<b>417724-5</b>	0,35 €
BTW450RFE	824777-1	<b>163467-4</b>	1,32 €
BUC122RFE	824820-6	<b>163455-1</b>	0,92 €
BVR450RFE	824768-2	<b>417383-5</b>	0,28 €
DA302D	824627-0	<b>186347-7</b>	1,31 €
DA312D	824627-0	<b>186347-7</b>	1,31 €
DA312DWAE	824627-0	<b>186347-7</b>	1,31 €
DA391DW	824627-0	<b>186347-7</b>	1,31 €
DA392D	824627-0	<b>186347-7</b>	1,31 €
DA400LR	824646-6	<b>163467-4</b>	1,32 €
DA6300	181791-3		
DA6301	181791-3		
DBM080	P-45135		
DBM130	P-45141		
DF010DSE	824781-0	<b>417724-5</b>	0,35 €
DF030DWE	824842-6	<b>417724-5</b>	0,35 €
DF330DWE	824842-6	<b>417724-5</b>	0,35 €
DK1150	E02248-2		
DK1867	824774-7	<b>417724-5</b>	0,35 €
DP3003	824595-7	<b>417059-4</b>	0,20 €
DP4001	824595-7	<b>417059-4</b>	0,20 €
DP4003	824595-7	<b>417059-4</b>	0,20 €
DP4010	P-04101		
DP4011	P-04101		
DP4700	P-04101		

Model	kufor	spona	cena s DPH
FS2700	824890-5		
GA4530	188627-7		
GA5030	188627-7		
GA7010C	824878-5	<b>163455-1</b>	0,92 €
GA7020	824878-5	<b>163455-1</b>	0,92 €
GA7030	824878-5	<b>163455-1</b>	0,92 €
GA7040	824878-5	<b>163455-1</b>	0,92 €
GA9010C	824878-5	<b>163455-1</b>	0,92 €
GA9020	824878-5	<b>163455-1</b>	0,92 €
GA9020SFK	824878-5	<b>163455-1</b>	0,92 €
GA9030	824878-5	<b>163455-1</b>	0,92 €
GA9040	824878-5	<b>163455-1</b>	0,92 €
HG5002K	HG118897		
HG5012K	HG118897		
HG550VK	HG118897		
HG551VK	HG118897		
HG650CK	HG118897		
HG651CK	HG118897		
HK0500	824523-2	<b>163455-1</b>	0,92 €
HK1810	150640-5	<b>417059-4</b>	0,20 €
HK1820	824789-4	<b>417724-5</b>	0,35 €
HM0810	150879-0	<b>417383-5</b>	0,28 €
HM0810B	150878-2	<b>162202-7</b>	1,02 €
HM0810T	150879-0	<b>417383-5</b>	0,28 €
HM0860C	824708-0	<b>162202-7</b>	1,02 €
HM0870C	824905-8		
HM0871C	824904-0		
HM1100	150676-4	<b>416401-6</b>	2,23 €
HM1100C	150676-4	<b>416401-6</b>	2,23 €
HM1101C	140561-9		
HM1111C	140561-9		
HM1130C	150676-4	<b>163467-4</b>	1,32 €
HM1140C	150676-4	<b>163467-4</b>	1,32 €
HM1200	150583-1	<b>163467-4</b>	1,32 €
HM1200B	150586-5	<b>163467-4</b>	1,32 €
HM1200K	150583-1	<b>163467-4</b>	1,32 €
HM1202C	824564-8	<b>163467-4</b>	1,32 €
HM1203C	824876-9	<b>162271-8</b>	1,47 €
HM1213C	824908-2	<b>162271-8</b>	1,47 €
HM1214C	824882-4	<b>162271-8</b>	1,47 €
HM1303	182714-4		
HM1303B	182851-4		
HM1304	183567-4		
HM1304B	183598-3		
HM1307C	824898-9		
HM1307CB	824898-9		
HM1317C	824897-1		
HP1620K	824724-2	<b>183091-7</b>	1,73 €
HP1621K	824724-2	<b>183091-7</b>	1,73 €
HP1630K	824811-7	<b>417724-5</b>	0,35 €



## Spony pre prepravné kufre

Model	kufor	spona	cena s DPH
HP1631K	824811-7	<b>417724-5</b>	0,35 €
HP1640K	824724-2	<b>183091-7</b>	1,73 €
HP1641K	824724-2	<b>183091-7</b>	1,73 €
HP1830	824650-5	<b>417724-5</b>	0,35 €
HP2030	824485-4	<b>183091-7</b>	1,73 €
HP2031	824485-4	<b>183091-7</b>	1,73 €
HP2050	824650-5	<b>417724-5</b>	0,35 €
HP2051	824650-5	<b>417724-5</b>	0,35 €
HP2051F	824650-5	<b>417724-5</b>	0,35 €
HP2070	824650-5	<b>417724-5</b>	0,35 €
HP2071	824650-5	<b>417724-5</b>	0,35 €
HP2071F	824650-5	<b>417724-5</b>	0,35 €
HR160DWA	824550-9	<b>417059-4</b>	0,20 €
HR1830	824650-5	<b>417724-5</b>	0,35 €
HR2010	824464-2	<b>186347-7</b>	1,31 €
HR2020	824650-5	<b>417724-5</b>	0,35 €
HR2230	824799-1	<b>417724-5</b>	0,35 €
HR2400	824445-6	<b>182935-8</b>	2,64 €
HR2410	824445-6	<b>182935-8</b>	2,64 €
HR2430	824575-3	<b>417059-4</b>	0,20 €
HR2431	824575-3	<b>417059-4</b>	0,20 €
HR2432	824729-2	<b>163455-1</b>	0,92 €
HR2440	824650-5	<b>417724-5</b>	0,35 €
HR2450	824650-5	<b>417724-5</b>	0,35 €
HR2450T	824695-3		
HR2460	824799-1	<b>417724-5</b>	0,35 €
HR2470	824799-1	<b>417724-5</b>	0,35 €
HR2470T	824799-1	<b>417724-5</b>	0,35 €
HR2600	141856-3	<b>162302-3</b>	0,77 €
HR2650/2651	141856-3	<b>162302-3</b>	0,77 €
HR2800	824789-4	<b>417724-5</b>	0,35 €
HR2810	824789-4	<b>417724-5</b>	0,35 €
HR2810T	824789-4	<b>417724-5</b>	0,35 €
HR2811F	824789-4	<b>417724-5</b>	0,35 €
HR2811FT	824789-4	<b>417724-5</b>	0,35 €
HR3000C	824559-1	<b>163467-4</b>	1,32 €
HR3200C	824819-1	<b>163467-4</b>	1,32 €
HR3210C	824825-6	<b>163467-4</b>	1,32 €
HR3210FCT	824825-6	<b>163467-4</b>	1,32 €
HR3520	150597-0	<b>163467-4</b>	1,32 €
HR3540C	824819-1	<b>163467-4</b>	1,32 €
HR3541FC	824819-1	<b>163467-4</b>	1,32 €
HR3550C	824559-1	<b>163467-4</b>	1,32 €
HR3850	150582-3	<b>163467-4</b>	1,32 €
HR3850K	150582-3	<b>163467-4</b>	1,32 €
HR4000C	824479-9	<b>416401-6</b>	2,23 €
HR4001C	158693-8	<b>163467-4</b>	1,32 €
HR4002	824798-3	<b>163467-4</b>	1,32 €
HR4010C	158691-2	<b>163467-4</b>	1,32 €
HR4011C	158692-0	<b>163467-4</b>	1,32 €

Model	kufor	spona	cena s DPH
HR4500C	824607-6	<b>163467-4</b>	1,32 €
HR4501C	158274-8	<b>163467-4</b>	1,32 €
HR4510C	158275-6	<b>163467-4</b>	1,32 €
HR4511C	158273-0	<b>163467-4</b>	1,32 €
HR5001C	824519-3	<b>163467-4</b>	1,32 €
HR5201C	158274-8	<b>163467-4</b>	1,32 €
HR5210C	158275-6	<b>163467-4</b>	1,32 €
HR5211C	158273-0	<b>163467-4</b>	1,32 €
824961-8	HS300D		
JN3200	181797-1		
JR1000FTK	824722-6	<b>417059-4</b>	0,09 €
JR180DWD	824565-6	<b>417152-4</b>	1,07 €
JR3000V	824539-7	<b>417059-4</b>	0,20 €
JR3000VT	824539-7	<b>417059-4</b>	0,20 €
JR3020	824539-7	<b>417059-4</b>	0,20 €
JR3030	824539-7	<b>417059-4</b>	0,20 €
JR3030T	824539-7	<b>417059-4</b>	0,20 €
JR3050T	824734-9	<b>417724-5</b>	0,35 €
JR3060T	824734-9	<b>417724-5</b>	0,35 €
JR3070CT	824734-9	<b>417724-5</b>	0,35 €
JS3200	181797-1		
KP0810	824786-0		
KP0810C	824786-0		
LCT304	824842-6		
MEU041	824888-2		
NHP1300S	824700-6		
PC1100	181789-0		
PC5000C	140073-2		
SC130DRA	SC08100910		
SG1250	824709-8	<b>163455-1</b>	0,92 €
SG150	B50856		
SKR60	LM.400.02		
SKR301	ZA.023.0M		
SP6000K	824783-6		
T221DW	183771-5		
TD020DSE	831272-4		
TD090DWE	824842-6	<b>417724-5</b>	0,35 €
TW0200	824703-0	<b>186347-7</b>	1,31 €
TW0350	824702-2	<b>186347-7</b>	1,31 €
TW1000	824737-3	<b>416401-6</b>	2,23 €
UC120DWAE	824491-9	<b>417059-4</b>	0,20 €
VR250DWAE	824486-2		
VR250DWDE	824486-2		



# Uhlíky

model	obj. číslo	model	obj. číslo	model	obj. číslo	model	obj. číslo	model	obj. číslo
440	80051B5X*	6501	CB-70	9920	CB-303	BFT122FZ	CB-434	BTD130	CB-448
445X	80050B0X*	6510LVR	CB-64	9924DB	CB-100	BFT123FZ	CB-434	BTD134	CB-448
446L	W49625*	6821	CB-419	BCS550	CB-430	BFT124FZ	CB-434	BTD140	CB-448
447L	W49625*	6822	CB-419	BDA340	CB-448	BFT124RZ	CB-434	BTD146	CB-448
448	80051B5X*	6823	CB-419	BDA341	CB-448	BFT125FZ	CB-434	BTP130	CB-448
906	CB-64	6824	CB-419	BDA350	CB-448	BFT126FZ	CB-434	BTP140	CB-448
1806B	CB-153	6825R	CB-419	BDA351	CB-448	BGA450	CB-430	BTP141	CB-448
1902	CB-51	6826	CB-419	BDF440	CB-448	BGA452	CB-430	BTS130	CB-448
1911B	CB-106	6827	CB-419	BDF441	CB-448	BGD800	CB-430	BTW200	CB-441
1923H	CB-132	6842	CB-411	BDF442	CB-448	BHP440	CB-448	BTW250	CB-448
2012NB	CB-153	6844	CB-411	BDF444	CB-448	BHP441	CB-448	BTW251	CB-448
2107FK	CB-303	6904VH	CB-415	BDF446	CB-448	BHP442	CB-448	BTW450	CB-441
2414EN	CB-203	6905B	CB-65	BDF448	CB-448	BHP444	CB-448	BUB360	CB-430
2414NB	CB-203	6905H	CB-415	BDF450	CB-448	BHP446	CB-448	BUC122	CB-430
2704	CB-153	6906	CB-100	BDF451	CB-448	BHP448	CB-448	BUC250	CB-442
3612C	CB-203	6916FD	CB-431	BDF452	CB-448	BHP450	CB-448	BUH550	CB-442
3612	CB-203	6918FD	CB-434	BDF454	CB-448	BHP451	CB-448	CA5000	CB-303
3620	CB-106	6934FD	CB-434	BDF456	CB-448	BHP452	CB-448	DA3010F	CB-419
3706	CB-64	6935FD	CB-434	BDF458	CB-448	BHP454	CB-448	DA3011F	CB-419
3707	CB-411	6936FD	CB-434	BFL060FZ	CB-434	BHP456	CB-448	DA4000LR	CB-303
3708	CB-411	6951	CB-411	BFL061FZ	CB-434	BHP458	CB-448	DA6301	CB-100
3709	CB-411	6953	CB-411	BFL080FZ	CB-434	BHR162	CB-430	DBM080	EE80700019**
3710	CB-411	6980FD	CB-434	BFL081FZ	CB-434	BHR200	CB-430	DBM130	EE80700019**
3901	CB-411	7104L	CB-153	BFL082FZ	CB-434	BHR202	CB-441	DBM230	EE80700019**
4101RH	CB-303	8414D	CB-430	BFL120FZ	CB-434	BHR240	CB-430	DBN500	CB-448
4105KB	CB-100	8434D	CB-430	BFL122FZ	CB-434	BHR241	CB-441	DCO180	CB-430
4112HS	CB-204	8444D	CB-430	BFL200FZ	CB-434	BHR261	CB-442	DCS550	CB-430
4131	CB-303	9031	CB-411	BFL201FZ	CB-434	BHR262	CB-442	DDA340	CB-448
4157KB	CB-153	9032	CB-411	BFL201RZ	CB-434	BHS630	CB-441	DDA341	CB-448
4326	CB-64	9046	CB-419	BFL202FZ	CB-434	BJN161	CB-430	DDA350	CB-448
4327	CB-64	9079SF	CB-204	BFL300FZ	CB-434	BJR181	CB-411	DDA351	CB-448
4329	CB-64	9207SPB	CB-100	BFL301FZ	CB-434	BJS101	CB-430	DDF446	CB-448
4350	CB-419	9227CB	CB-303	BFL301RZ	CB-434	BJS130	CB-448	DDF448	CB-448
4351	CB-419	9237CB	CB-303	BFL400FZ	CB-434	BJV140	CB-430	DDF456	CB-448
5017RKB	CB-303	9403	CB-303	BFL402FZ	CB-434	BJV180	CB-430	DDF458	CB-448
5103R	CB-203	9404	CB-303	BFL402RZ	CB-434	BKP180	CB-441	DDF482	CB-448
5104S	CB-203	9554/55NB	CB-325	BFR440	CB-448	BLS713	CB-441	DFR440	CB-448
5143R	CB-203	9557/58	CB-325	BFR540	CB-448	BO3700	CB-64	DFR540	CB-448
5603R	CB-303	9562CH/CVH	CB-318	BFR550	CB-448	BO3710	CB-64	DFR550	CB-448
5604R	CB-303	9562CR	CB-318	BFR750	CB-448	BO3711	CB-64	DFR750	CB-448
5704R	CB-303	9562CVH	CB-318	BFS440	CB-448	BO4555	CB-419	DFS440	CB-448
5705R	CB-303	9562CVR	CB-318	BFS441	CB-448	BO4556	CB-419	DFS450	CB-448
5903R	CB-203	9564H	CB-325	BFS450	CB-448	BO4557	CB-419	DFS451	CB-448
6013B	CB-51	9565C/CV	CB-318	BFS451	CB-448	BO4565	CB-419	DGA450	CB-430
6207D	CB-430	9565CLR	CB-318	BFT020FZ	CB-434	BO4900V	CB-419	DGA452	CB-430
6300-4	CB-51	9565CR	CB-318	BFT022FZ	CB-434	BO5021	CB-64	DGD800	CB-430
6305	CB-303	9565CVL	CB-318	BFT040FZ	CB-434	BO5030	CB-419	DHP446	CB-448
6317D	CB-430	9565CVR	CB-318	BFT041FZ	CB-434	BO5031	CB-419	DHP448	CB-448
6319D	CB-430	9565H	CB-325	BFT041RZ	CB-434	BO5041	CB-64	DHP456	CB-448
6337D	CB-430	9565HZ1	CB-325	BFT042FZ	CB-434	BO6030	CB-419	DHP458	CB-448
6339D	CB-430	9565PCV	CB-318	BFT043FZ	CB-434	BO6040	CB-318	DHP482	CB-448
6347D	CB-430	9566C/CV	CB-318	BFT044FZ	CB-434	BO6050	CB-325	DHR162	CB-430
6349D	CB-430	9566CR	CB-318	BFT080FZ	CB-434	BPB180	CB-430	DHR164	CB-430
6408	CB-419	9566CVR	CB-318	BFT082FZ	CB-434	BPJ180	CB-430	DHR165	CB-430
6412	CB-64	9741	CB-100	BFT082RZ	CB-434	BSS500	CB-430	DHR202	CB-441
6413	CB-64	9903	CB-303	BFT083FZ	CB-434	BSS501	CB-430		
6501X	CB-70	9910/11	CB-411	BFT084FZ	CB-434	BSS610	CB-411		

\* zároveň obj. číslo; \*\* zároveň obj. číslo, iba 1 ks v balení

# Uhlíky

model	obj. číslo	model	obj. číslo	model	obj. číslo	model	obj. číslo	model	obj. číslo
DHR241	CB-441	GA5040R	CB-325	HP1631	CB-85	JS1600	CB-65	TD0101F	CB-411
DHR263	CB-442	GA5041C01	CB-325	HP1640	CB-419	JS1601	CB-459	TM3000C	CB-459
DHR264	CB-442	GA5041R	CB-325	HP1641	CB-419	JS1602	CB-459	TM3010C	CB-459
DHS630	CB-441	GA5041X01	CB-325	HP2050	CB-419	JS1660	CB-65	TW0200	CB-411
DHS710	CB-442	GA6021	CB-303	HP2051	CB-419	JS1670	CB-65	TW0350	CB-411
DJN161	CB-430	GA6040C01	CB-325	HP2070	CB-419	JS3200	CB-100	TW1000	CB-153
DJR181	CB-411	GA7010C	CB-204	HP2071	CB-419	JS3201	CB-303	UB1101	CB-303
DJS101	CB-430	GA7020	CB-204	HR1830	CB-419	JV0600	CB-64	UB1103	CB-303
DJS130	CB-448	GA7030	CB-204	HR2010	CB-105	KC100	CB-203	UB360D	CB430
DJV140	CB-430	GA7040	CB-204	HR2230	CB-325	KP0800	CB-411	UC250D	CB442
DJV180	CB-430	GA7060R	CB-204	HR2300	CB-325	KP0810	CB-132	UC3020A	CB-132
DKP180	CB-441	GA7061R	CB-204	HR2432	CB-419	KP0810C	CB-132	UC3030A	181044-0*
DLS713	CB-441	GA9010	CB-204	HR2450	CB-419	KP312S	CB-203	UC3041A	CB-132
DP2010	CB-419	GA9020	CB-204	HR2460	CB-325	LC1230	CB-203	UC3051A	CB-153
DP2011	CB-419	GA9030	CB-204	HR2470	CB-325	LF1000	CB-153	UC3520A	CB-132
DP3003	CB-419	GA9040	CB-204	HR2600	CB-325	LH1040	CB-153	UC3530A	181044-0*
DP4001	CB-419	GA9050	CB-204	HR2610	CB-325	LH1200FL	JM23300083*	UC3541A	CB-132
DP4003	CB-419	GA9060R	CB-204	HR2611	CB-325	LH1201FL	JM23000123*	UC3551A	CB-153
DP4010	CB-419	GA9061R	CB-204	HR2630	CB-325	LS0714	CB-303	UC4020A	CB-132
DP4011	CB-419	GD0600	CB-325	HR2630T	CB-325	LS0714FL	CB-303	UC4030A	181044-0*
DP4700	CB-64	GD0601	CB-325	HR2631F	CB-325	LS0815FL	JM23500117	UC4041A	CB-132
DPB180	CB-430	GD0602	CB-325	HR2631FT	CB-325	LS1013	CB-153	UC4051A	CB-153
DPJ180	CB-430	GD0603	CB-64	HR2641	CB-325	LS1013L	CB-153	UC4530A	181044-0*
DS4010	CB-411	GD0800C	CB-318	HR2800	CB-325	LS1016	CB-153	UC4551A	CB-153
DS4011	CB-411	GD0801C	CB-318	HR2810	CB-325	LS1016L	CB-153	UH4260	CB-419
DSC191	CB-448	GD0810C	CB-318	HR2811F	CB-325	LS1018L	JM23000123*	UH4261	CB-419
DSS500	CB-430	GD0811C	CB-318	HR2811FT	CB-325	LS1040	CB-153	UH4570	CB-419
DSS610	CB-411	HB500	EIB106C*	HR3200C	CB-350	LS1214	CB-153	UH4860	CB-419
DTD134	CB-448	HK0500	CB-113	HR3210C	CB-350	LS1214L	CB-153	UH4861	CB-419
DTD146	CB-448	HK1820	CB-350	HR3210FCT	CB-350	LS1216	CB-153	UH5260	CB-419
DTD152	CB-448	HK1820L	CB-350	HR3540C	CB-350	LS1216L	CB-153	UH5261	CB-419
DTP141	CB-448	HM0810T	CB-105	HR3541FC	CB-350	LS1440	CB-154	UH550D	CB442
DTS130	CB-448	HM0860C	CB-327	HR4001C	CB-350	LW1400	CB-203	UH5540	223804410*
DTW250	CB-448	HM0870C	CB-350	HR4002	CB-350	LW1401	CB-203	UH5550	957800410*
DTW251	CB-448	HM0871C	CB-350	HR4003C	CB-175	MLS100	JM23000123*	UH5570	CB-419
DTW450	CB-441	HM1101C	CB-175	HR4011C	CB-350	MLT100X	JM23000123*	UH5580	CB-419
DUB361	CB-430	HM1111C	CB-175	HR4013C	CB-175	N1923B	CB-51	UH6350	957800410*
DUC122	CB-430	HM1200	CB-155	HR4501C	CB-175	N5900B	CB-153	UH6540	223804410*
DVC860L	CB-353	HM1200B	CB-155	HR4510C	CB-175	PC1100	CB-100	UH6570	CB-419
FS2300	CB-419	HM1202C	CB-155	HR4511C	CB-175	PC5000C	CB-253	UH6580	CB-419
FS2700	CB-419	HM1203C	CB-175	HR5201C	CB-175	PC5001C	CB-253	UH7580	CB-419
FS4000	CB-419	HM1205C	CB-175	HR5202C	CB-175	PJ7000	CB-459	UR3500	YA00000504*
FS4300	CB-419	HM1213C	CB-175	HR5210C	CB-175	PV7000C	CB-303	UR3501	YA00000504*
FS6300R	CB-419	HM1214C	CB-175	HR5211C	CB-175	PW5000CH	CB-318	UT120	EE80700013**
GA4530	CB-459	HM1304	CB-204	HR5212C	CB-175	RP0900	CB-107	UT1200	EE80700032
GA4530R	CB-459	HM1304B	CB-204	HS6101	CB-147	RP0910	CB-303	UT1305	CB-303
GA4540	CB-325	HM1307C	CB-175	HS7101	CB-147	RP1110C	CB-303	UT1400	EE80700013**
GA4540C01	CB-325	HM1307CB	CB-175	HS7601	CB-303	RP1800FX	CB-203	UT1401	EE80700013**
GA4540R	CB-325	HM1317C	CB-175	JN1601	CB-411	RP2300FCX	CB-203	UT1600	EE80700019**
GA4541C01	CB-325	HM1400	CB-155	JN3200	CB-100	RT0700C	CB-411	UT2204	CB-303
GA4541R	CB-325	HM1801	CB-204	JN3201	CB-303	SA5040C	CB-318	VC2211	CB-173
GA4541X01	CB-325	HM1802	CB-218	JR1000FTK	CB-419	SA7000C	CB-204	VC3210	CB-173
GA5021	CB-303	HM1810	CB-204	JR180DWDE	CB-432	SG1250	CB-318	VC3211	CB-173
GA5030	CB-459	HM1812	CB-218	JR3050T	CB-303	SG1251J	CB-318		
GA5030R	CB-459	HP1620	CB-419	JR3060T	CB-303	SG1500	B45872**		
GA5040	CB-325	HP1621	CB-419	JR3070CT	CB-303	SP6000	CB-303		
GA5040C01	CB-325	HP1630	CB-85	JS1000	CB-459	SP6000K	CB-303		

\* zároveň obj. číslo; \*\* zároveň obj. číslo, iba 1 ks v balení

# Uhlíky

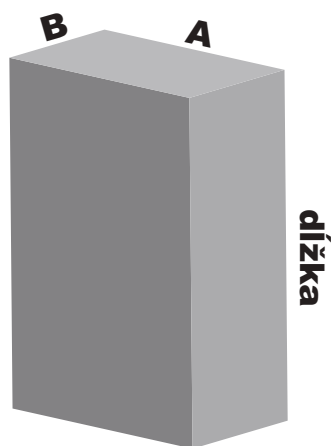

typ	objednávacie číslo	dĺžka	šírka A	hĺbka B	cena s DPH
CB-51	181021-2	11,8	8	5	1,60 €
CB-55	181026-2	11,7	8	5	2,48 €
CB-64	191627-8	10,8	8	5	1,57 €
CB-65	191628-6	11,7	8	5	2,58 €
CB-70	191914-5	10,8	8	5	2,41 €
CB-100	181030-1	14,8	10	6	1,70 €
CB-105	181038-5	15,3	9,9	5,9	4,99 €
CB-106	181410-1	14,8	10	6	3,59 €
CB-113	191904-8	14,8	9,9	6	6,20 €
CB-132	191972-1	14,7	10	6	3,00 €
CB-153	181044-0	17,8	13,4	6,5	1,99 €
CB-154	181047-4	17,8	13,4	6,5	3,17 €
CB-155	181048-2	17,8	13,4	6,5	5,26 €
CB-173	195483-8	k.A.	k.A.	k.A.	7,20 €
CB-175	195844-2	26,6	8,4	6,5	3,43 €
CB-203	191953-5	15,8	17,9	6,9	2,32 €
CB-204	191957-7	16,2	17,9	7	2,91 €
CB-218	197129-2	23,7	17,9	6,9	4,49 €
CB-251	194547-5	16,8	10,9	6,9	2,98 €
CB-253	194547-5	16,8	10,9	6,9	2,98 €
CB-303	191963-2	17,8	10,9	5	2,32 €
CB-318	191978-9	15,7	10,9	5	6,17 €
CB-325	194074-2	15,8	11	4,9	1,50 €
CB-327	194285-9	16,8	11	4,9	4,70 €
CB-350	194160-9	25,3	10,9	6,5	4,12 €
CB-353	197208-6	k.A.	k.A.	k.A.	18,99 €
CB-411	191940-4	11,7	8,9	6	2,50 €
CB-414	191949-6	11,6	5,7	3,7	3,90 €
CB-415	191950-1	8,7	8,9	6	3,85 €
CB-417	191955-1	9,4	8,9	6	5,99 €
CB-419	191962-4	11,3	9	6	1,59 €
CB-424	191966-6	8,7	5,3	4,8	2,18 €
CB-430	191971-3	9,7	7,2	6,9	2,26 €
CB-434	193466-2	11,8	5,8	4,9	2,74 €
CB-441	194435-6	10,8	10,8	6,9	3,40 €
CB-442	194928-3	10,8	10,7	6,9	2,45 €
CB-448	196854-2	13,3	9,9	3	3,00 €
CB-459	194722-3	12,8	8,9	6	1,90 €
80051B5X		28	11,2	6,2	10,99 €
80050B0X		k.A.	k.A.	k.A.	13,90 €
B45872 (iba 1 ks)		20	9,9	6,2	10,50 €
EE80700013 (iba 1 ks)		17,9	9,9	6,2	6,65 €
EE80700019 (iba 1 ks)		20	15,9	6,2	6,65 €
EIB106C		k.A.	k.A.	k.A.	29,99 €
JM23000123		17,3	13,4	6,5	2,80 €
W49625		32	10,9	6,3	39,99 €
JM23500117		k.A.	k.A.	k.A.	2,49 €
EE80700032		k.A.	k.A.	k.A.	7,20 €
EE80700019		k.A.	k.A.	k.A.	6,66 €
YA00000504		k.A.	k.A.	k.A.	1,21 €



# Použitie 1,3 Ah bateriek

14.4V BL1415 / 194558-0		14.4V BL1415 / 194558-0		18V BL1815 / 194513-2		18V BL1815 / 194513-2	
DDF441	x			DDF451	x	DJS161	x
DDF444	x	DGA450	x	DDF454	x	DGA402	x
DDF442	x			DDF452	O	DGA452	x
DDF440	x	BSS500	x	DDF450	O	BSS501	x
DDF445	O			DDF453	O	BSS610	x
DDF446	x	DJV140	x	DDF456	O	BSS611	x
DDF343	O						
		BST110	x	DHP451	x		
DHP441	x	BST220	x	DHP454	x	DJV180	x
DHP444	x			DHP452	O	DJS100	x
DHP446	x	BPT350	x	DHP456	O	BVC350	O
DHP442	x			DHP450	O		
DHP440	x	DUC121	x	DHP453	O		
DHP343	O						
		BVR440/ BVR340	x	BTD140	O		
BTD130F	x			BTD141	O	BST221	x
BTD132	x	BUB142	O	BTD142	O		
BTD133	x			BTD144	O	DUC122	x
BTD135	O	DCL140	O	BTD145	O		
						BVR850/ BVR450/ BVR350	x
BTP130	x	BML145	O	BTP140	O		
		BML184	O			BVF104D/ BVF154D	O
BTS130	x	BML186	O	BTL061	O		
				BTL063	O	BUB182	O
BTL060	x						
BTL062	x	DKP140	x	BDA350/ BDA351	x	DCL180	O
						DCL182	O
BDA340/ BDA341	x			BFS450	O		
				BFS451	O	BML146	O
BFS440	O					BML185	O
BFS441	O			DFR550	O	BML184	O
				DFR750	O		
DFR440	O						
DFR540	O			BTW251	O	BGD800	x
				BTW253	O	BGD801	x
BTW152	x			BTW450	x		
BTW250	x					DKP180	x
DHR162	x			DHR202	x	DHS630	x
				DHR241	x		
DCL142	O			BCS550	x	DLS713	x
						BMR050	O
DJR141	x			DJR181	x	BML800	O
				DJR182	x	BMR100/ BMR101	O
BVC340	O						
				BPB180	x		
DJS101	x						
DJS160	x			DJS130	O		



X – nevhodné  
O – vhodné

# Používané označenia pri akumulátorových strojoch Makita



## VYSVETLIVKY

### 18 V / 12 V MAX program

- Z – dodávané bez akumulátora a nabíjačky
- J – dodávané v systainery
- K – dodávané v kufri
- X – extra príbal príslušenstva
- PT2 – Dvojnabíjačka /rýchlonabíjačka/, 2 ks 5,0 Ah akumulátor
- PT4 – Dvojnabíjačka /rýchlonabíjačka/, 4 ks 5,0 Ah akumulátor
- PF2 – Rýchlonabíjačka, 2 ks 3,0 Ah akumulátor
- RF – Rýchlonabíjačka, 1 ks 3,0 Ah akumulátor
- SYE – Nabíjačka, 2 ks 1,5 Ah akumulátor
- RFJ – Rýchlonabíjačka, 2 ks 3,0 Ah akumulátor, systainer
- RFE – Rýchlonabíjačka, 2 ks 3,0 Ah akumulátor
- RTE – Rýchlonabíjačka, 2 ks 5,0 Ah akumulátor
- RTJ – Rýchlonabíjačka, 2 ks 5,0 Ah akumulátor, systainer
- RF3J – Rýchlonabíjačka, 3 ks 3,0 Ah akumulátor, systainer
- RFEB – Rýchlonabíjačka, 2 ks 3,0 Ah akumulátor, čierne prevedenie stroja
- RTJV – Rýchlonabíjačka, 2 ks 5,0 Ah akumulátor, systainer, odsávacie zariadenie
- DZ – dodávané bez akumulátora a nabíjačky
- DSAE – Rýchlonabíjačka, 2 ks 2,0 Ah akumulátor
- DSME – Rýchlonabíjačka, 2 ks 4,0 Ah akumulátor

### Označenie akumulátorov

- Y – 1,5 Ah
- A – 2,0 Ah
- F – 3,0 Ah
- M – 4,0 Ah
- T – 5,0 Ah
- G – 6,0 Ah

**22**min

## Rýchlejšie nabíjanie s chladiacim ventilátorom

Čas nabíjania v praxi

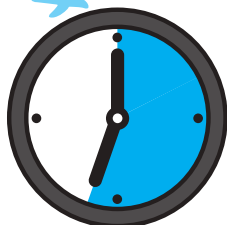

Spolu **22**min



Po použití môže byť teplota batérií veľmi vysoká a skôr než batériu začnete dobíjať, je potrebné ochladiť ju. Spoločnosť Makita vyvinula originálny systém dobíjania so vstavaným chladiacim ventilátorom. Ak sa nezačne nabíjať, čas prestoja sa účinným chladením výrazne skráti. Navyše nabíjačka sa pri dobíjaní stále ochladzuje a batéria sa rýchlo nabije.

## Dobre vyvážené chladenie

Batéria je navrhnutá tak, aby vzduch prúdil účinne okolo celej batérie, aby rovnomerne a rýchlo ochladzoval jednotlivé elementy.

Optimálne prúdenie vzduchu

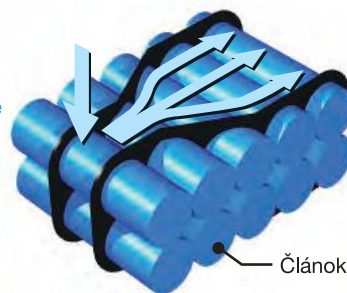

## O 40 % ľahšia



MAKITA  
18V /14,4 V  
Ni-MH 2,8 Ah

MAKITA  
18 V Li-ion 3,0 Ah  
14,4 V Li-ion 3,0 Ah



## Pevné uchytenie

Terminály s viacerými kontaktmi znižujú elektrický odpor a zvyšujú stabilitu pripojenia s odolnosťou voči vibráciám a najlepšie zabezpečujú stabilný prívod prúdu do nástroja.





430%

# Extrémna húževnatosť

Kapacita počas celej životnosti

Nabíjačka komunikuje s individuálnym elementom batérie a reguluje prúd, napätie a teplotu. Dosahuje sa nabíjanie, ktoré je rýchle a optimálne, čím sa zabezpečuje dlhšia životnosť batérie.

**Celkové množstvo dodanej energie každej batérie počas celej životnosti**

	<b>Li-ion 6.0Ah</b>	<b>850</b>
	<b>Li-ion 5.0Ah</b>	<b>710</b>
	<b>Li-ion 4.0Ah</b>	<b>570</b>
	<b>Li-ion 3.0Ah</b>	<b>430</b>
	<b>Ni-MH 2.8Ah</b>	<b>130</b>
	<b>Ni-Cd 1.9Ah</b>	<b>100</b>

Hodnoty v grafe sú relatívnymi hodnotami, keď je hodnota pre batériu Ni-Cd 2,0 Ah uvažovaná ako 100.



Tradičná metóda nabíjania

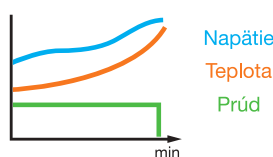

Optimálne nabíjanie

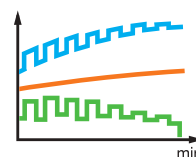

### Vstavaný pamäťový čip

Pamäťový čip zabudovaný v batérii zaznamenáva históriu používania batérie a prenáša ju na nabíjačku.



Digitálna komunikácia



### Zabudovaná jednotka CPU

Processor zabudovaný v nabíjačke analyzuje stav batérie, vysokú teplotu, opätovné nabíjanie po plnom nabití, príliš intenzívne vybíjanie. Batéria má dlhú životnosť, pretože je možné nabíjať ju tou najlepšou metódou za ten najlepší čas.



## Dobre vyvážené nabíjanie

**MAKITA: Sada batérií s vyváženou kapacitou**

- Je navrhnutá tak, aby dobre fungovali jednotlivé elementy, ktoré sú v plne nabitom stave, vybité aj prázdne. Je ťažké dosiahnuť príliš rýchle vybíjanie a prebíjanie, pretože individuálna kapacita elementov zabraňuje anomáliám.
- Je možné efektívne využívanie, pretože kapacita všetkých elementov nie je nerovnomerná a vybíja sa rovnomerne.

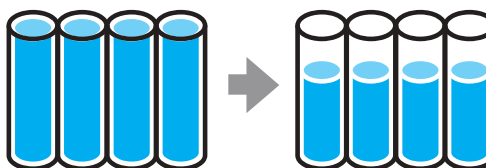

1. Plne nabité

2. Vybíjanie

### Nabíjanie kedykoľvek

Bez pamäťového efektu  
Nevyžaduje sa vybíjanie



### Odoláva rázom

Sada s robustnou odolnosťou



### Dlhodobé skladovanie

Nízka úroveň samovybíjania



## Batérie a nabíjačky pre optimálny systém nabíjania

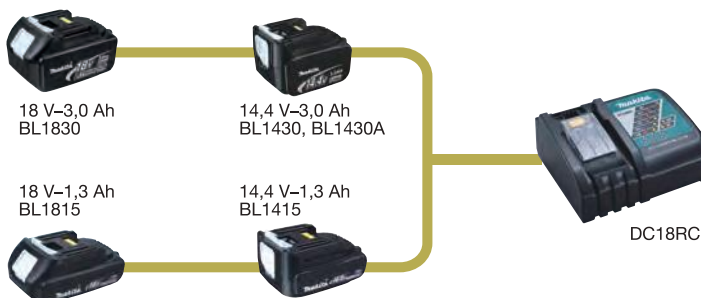















# Li-Ion akumulátory a nabíjačky

18V Lithium-ion		DC18RC DC18RD Dvojnabíjačka Rýchlonabíjačka DC18RE CXT&LXT Rýchlonabíjačka	DC18SF * Okrem BL1430A	DC18SD DC18SE (Automotive)	
6.0 Ah	BL1860B	Fast Charging 55 min.	1 až 2 akumulátory 130 min.	3 až 4 akumulátory 260 min.	130 min.
5.0 Ah	BL1850B		110 min.	220 min.	110 min.
4.0 Ah	BL1840B		90 min.	180 min.	90 min.
3.0 Ah	BL1830B		60 min.	120 min.	60 min.
2.0 Ah	BL1820B		45 min.	90 min.	45 min.
1.5 Ah	BL1815N		30 min.	60 min.	30 min.

12V max Lithium-ion		DC18RE CXT&LXT Rýchlonabíjačka DC10SB	DC10WD	10.8V Lithium-ion	DC10WA
4.0 Ah	BL1041B	Fast Charging 60 min.	130 min.	1.3 Ah BL1013	50 min.
2.0 Ah	BL1021B		70 min.		
1.5 Ah	BL1016		50 min.		
				7.2V Lithium-ion	DC10WA
1.5 Ah	BL0715			1.5 Ah BL0715	35 min.

18V Lithium-ion		DC18WA
1.5 Ah	BL1815G Pre model: DF347D, HP347D, JV143D, ML187, TD126D, UH420D, UH480D, UH520D, UM165D, UR140D, DMR106	DC18WA 70 min.

# Akumulátory Li-Ion

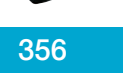
	Volt	Ah	typ	model	objednávacie číslo	cena s DPH
	7,2	1,0	Li-Ion	BL7010	198000-3	45,90 €
	10,8	1,3	Li-Ion	BL1013	194550-6	42,90 €
	12	2,0	Li-Ion s ukazovateľom kapacity akumulátora	BL1020B	197394-3	44,90 €
	12	4,0	Li-Ion s ukazovateľom kapacity akumulátora	BL1041B	197406-2	69,90 €
	14,4	1,5	Li-Ion	BL1415N	196875-4	76,90 €
	14,4	3,0	Li-Ion	BL1430	197615-3	89,90 €
	14,4	4,0	Li-Ion	BL1440	196386-9	129,90 €
	18	1,5	Li-Ion	BL1815N	196235-0	77,77 €
	18	2,0	Li-Ion s ukazovateľom kapacity akumulátora	BL1820B	197254-9	89,90 €
	18	3,0	Li-Ion s ukazovateľom kapacity akumulátora	BL1830B	197599-5	89,90 €
	18	4,0	Li-Ion s ukazovateľom kapacity akumulátora	BL1840B	197265-4	109,90 €
	18	5,0	Li-Ion s ukazovateľom kapacity akumulátora	BL1850B	197280-8	121,50 €
	18	6,0	Li-Ion s ukazovateľom kapacity akumulátora	BL1860B	197422-4	159,90 €
	36	2,2	Li-Ion	BL3622A	195410-5*	281,10 €

## Sady akumulátorov v systainery 18V Li-Ion



objednávacie číslo	obsah	cena s DPH
197626-8	1ks systajner, 4 × BL1850B,1 × DC18RD	599,90 €
197629-2	1ks systajner, 2 × BL1850B,1 × DC18RD	399,90 €
197970-3	1ks systajner, 4 × BL1830B,1 × DC18RD	499,90 €
198077-8	1ks systajner, 2 × BL1860B,1 × DC18RD	499,90 €
198091-4	1ks systajner, 4 × BL1860B,1 × DC18RD	796,00 €

## Sady akumulátorov v systainery 12V max



objednávacie číslo	obsah	cena s DPH
197657-7	1ks systajner, 2 × BL1021B,1 × DC10SA	177,71 €

# Akumulátory Li-Ion G-séria



popis	Volt	Ah	typ	objednávacie číslo	cena s DPH
Li-Ion	18	1,5	BL1815G	198186-3	59,90 €
nabíjačka DC18WA pre BL1813G, BL1413G				195423-6	38,90 €

# Akumulátory Makstar



Volt	Ah	typ	model	objednávacie číslo	cena s DPH
9,6	1,8	Ni-MH	BH9020	193631-3	129,90 €
9,6	3,1	Ni-MH	BH9033	193636-3	159,90 €
12	1,8	Ni-MH	BH1220	193345-4	109,90 €
12	1,8	Ni-MH	BH1220C	193928-0	129,90 €
12	3,1	Ni-MH	BH1233	193348-8	169,90 €
12	3,1	Ni-MH	BH1233C	193930-3	149,90 €
24	3,1	Ni-MH	BH2433	193739-3	239,90 €







# Akumulátory Ni-MH a Ni-CD



Volt	Ah	typ	modell	objednávacie číslo	cena s DPH
9,6	2,5	Ni-MH	9134	193099-3*	98,26€
12	2,5	Ni-MH	1234	193100-4*	74,18€
12	2,8	Ni-MH	1235	193059-5*	72,44€
14,4	2,5	Ni-MH	1434	193101-2*	81,02€
14,4	2,8	Ni-MH	14,35	193060-0*	100,02€
18	2,5	Ni-MH	1834	193102-0*	109,52€
18	2,8	Ni-MH	1835	193061-8*	133,48€

\*do vypredania zásob

# Nabíjačky Li-Ion 14,4 V – 36 V

Čas nabíjania v minútach	Li-Ion (Ah)																obj. číslo	cena s DPH		
	6,0	5,0	4,0	3,0	2,6	2,2	1,5 1,3 1,0	MAKSTAR (Ah)				(Ah)								
<b>DC36RA 36 V</b>																				
	22																194863-5 <sup>1)</sup>	199,90 €		
<b>DC18SF 14,4 V – 18 V</b>																				
	130 (1-2 Aku)	110 (1-2 Aku)	90 (1-2 Aku)	60 (1-2 Aku)					30** (1-2 Aku)								196426-3	259,90 €		
	260 (3-4 Aku)	220 (3-4 Aku)	180 (3-4 Aku)	120 (3-4 Aku)					60** (3-4 Aku)											
<b>DC18RD 9,6 V – 18 V</b>																				
	55	45	36	22					15**	22 (30 min BH9033)	15 (20 min BH9020)					196933-6	169,90 €			
<b>DC18SD 7,2 V – 18 V</b>																				
	130	110	90	60					30**	70	40					194533-6	66,90 €			
<b>DC18RC 7,2 V – 18 V</b>																				
	55	45	36	22					15**	22 (30 min BH9033)	15 (20 min BH9020)	70*	60*	45*	30*	60*	45*	30*	195584-2	79,90 €
<b>DC18RE dual port CXT + LXT</b>																				
	55																198720-9	129,90 €		
<b>DC18SE 7,2 V – 18 V nabíjačka do auta 12 V – 24 V</b>																				
	130	110	90	60					30**	70	40	100*	85*	70*	45*	85*	70*	45*	194621-9	123,00 €

\* s adaptérom ADP04 (193947-6); \*\* neplatí pre model BL7010 a BL1013; 1) nabíja len BL3626; 2) nabíja len BL3622A

# Nabíjačky Li-Ion 7,2 V – 10,8 V, 12V max

Čas nabíjania v minútach	Li-Ion						obj. číslo	cena s DPH		
	4,0	2,0	1,3	1,0						
<b>DC10SA 12V max</b>										
	60 BL1040B	30 BL1020B					197355-3	59,90 €		
<b>DC10WA 7,2 V – 10,8 V</b>										
			50 BL1013	30 BL7010				194588-1	48,90 €	
<b>DC07SA 7,2 V</b>										
					30 BL7010				194320-3	39,90 €
<b>DC18RE dual port CXT + LXT</b>										
	60 BL1040B	30 BL1020B				30 BL7010	198720-9	129,90 €		

## Adaptéry pre nabíjačky







typ	popis	objednávacie číslo	cena s DPH
ADP04	adaptér pre DC14SA/SC, DC24SA/SC, DC18RA/RC/SE	193947-6	39,90 €
BAP24	adaptér akumulátora 24V, pre všetky batérie Makstar	193689-2	47,20 €
BAP36N	adaptér akumulátora 36V, pre BL3626, 3622A	195311-7**	46,90 €
BCV03	adaptér akumulátora 36 V, pre 2 x 1830 = 36 V stroje	196809-7***	99,90 €

\* nie je možné použiť pre 7,2V a 10,8V Li-Ion akumulátory

\*\* nie je možné použiť pre 36V krovinozrez

\*\*\* nie je možné použiť pre akumulátory BL1815 a 36 V krovinozrez

## Nabíjačky Ni-Cd / Ni-Mh

Čas nabíjania v minútach	Ah				Ah			obj. číslo	cena s DPH
	2,8	2,5	1,8 / 1,9	1,3	2,5	1,9	1,3		
DC1804 7,2 V – 18 V									
	70	60	45	30	60	45	30	193827-6	59,90 €
DC1822 7,2 V – 18 V nabíjačka do auta 12V									
	70 (90 min 1835/F)	60 (75 min 1834)	45 (60 min 1822)	30	60	45	30	193439-5	85,05 €
DC1439 7,2 V – 14,4 V									
	27	23	14	9	23	14	9	192935-0	149,90 €
DC1414 7,2 V – 14,4 V									
	70	60	45	30	60	45	30	193864-0	34,90 €

## Ochrana akumulátorov



popis	pre model	objednávacie číslo	cena s DPH
ochrana kontaktov akumulátora	BL3626	451153-2	1,20 €
	BL1415/BL1430/BL1815/N/ BL1830/BL1840	450128-8	0,27 €
	Ni-MH / Ni-CD	414938-7	0,14 €
ochrana tela akumulátora	BL1430	450599-9	11,80 €



## Adaptér pre chladiace bundy/vesty



popis	objednávacie číslo	cena s DPH
adaptér pre Li-Ion 10,8 V / 1,3 Ah	PE00000001	17,46 €
adaptér pre Li-Ion 14,4 V a 18 V / 1,3 Ah – 4,0 Ah	PE00000066	31,22 €

## Adaptér pre vyhrievané bundy/vesty



popis	objednávacie číslo	cena s DPH
adaptér pre Li-Ion 12Vmax	GM00001605	42,04 €
adaptér pre Li-Ion 14,4 / 18 V	GM00001607	43,87 €

## Bluetooth vysielateľ pre stroje s AWS systémom



popis	objednávacie číslo	cena s DPH
bluetooth vysielateľ	198900-7	68,45 €

## Adaptér na nabíjanie mobilov, tabletov a podobne, napájanie na 18 V / 14,4 V Li-Ion



popis	objednávacie číslo	cena s DPH
2 USB porty / 5V / 2,1 A každý (dodávané bez akumulátora) pre 14,4/18 V Li-Ionaku	ATAADP05	32,01 €
1 USB porty / 5V / 2,1 A, pre CXT 10,8 V Li-Ion aku (dodávané bez akumulátora)	ATAADP06	33,55 €
adaptér pre 36 V náradie (18 V × 2)	196809-7	99,90 €
12Vmax adaptér na nabíjanie mobilov/tabletov, (dodávané bez akumulátora)	DEAADP08	27,25 €

## Atrapy akumulátorov



popis	objednávacie číslo	cena s DPH
18 V Li-Ion 1,3 Ah G séria	Z74145-2	7,45 €
10,8 V Li-Ion 2,0 Ah CXT	Z86055-0	10,40 €
10,8 V Li-Ion 4,0 Ah CXT	Z86056-0	5,94 €
18 V Li-Ion 4,0 Ah LXT	Z86058-0	20,16 €
18 V Li-Ion 5,0 Ah LXT	Z86059-0	20,16 €
18 V Li-Ion 6,0 Ah LXT	Z86060-0	20,16 €

# Servisné sady pre vŕtacie a sekacie kladivá

Uhlíky, O-krúžok, piestny krúžok, vazelína na prevodovku



obj. číslo	model	cena s DPH
193232-7	8035NB	22,96 €
195208-0	BHR162/DHR162	12,12 €
195258-5	BHR200	14,23 €
195193-7	BHR202/DHR202/BHR241/DHR241	12,59 €
195834-5	DHR243	11,51 €
195189-8	BHR261/BHR262	14,26 €
195198-7	HR1830	12,07 €
193396-7	HR2010 (točiaca sa časť)	13,78 €
193395-9	HR2010 (klzná časť)	14,94 €
193606-2	HR2020/ HR2021/ HR2022/ HR2432/ HR2440/F/ HR2441/ HR2442/ HR2445/ HR2450/F/FT/T/ HR2451/ HR2452/ HR2453/ HR2454/ HR2455	14,86 €
195263-2	HR2230/HR2460/HR2470/T	12,99 €
195105-0	HR2300/HR2600/HR2610	10,78 €
195106-8	HR2310T/HR2610T	10,28 €
195108-4	HR2611FT	9,60 €
193387-8	HR2400 (točiaca sa časť)	20,21 €
193386-0	HR2400 (klzná časť)	21,99 €
193388-6*	HR2410/HR2420/HR2430/HR2431	13,92 €
193389-4	HR2410 /HR2420	12,72 €
193404-4	HR2510	16,83 €
195206-4	HR2800/HR2810/T/HR2811FT	12,16 €
193390-9	HR3000C	19,20 €
195199-5	HR3200C/HR3210FCT/C	19,39 €
193280-6	HR3520	30,54 €
193406-0	HR3550C	24,39 €
195192-9	HR3540C/HR3541C	18,23 €
193281-4	HR3850/B	32,80 €
193283-0	HR4000C	24,20 €

obj. číslo	model	cena s DPH
196532-4	HR4003C/HR4013C	33,95 €
193407-8	HR4500C	24,95 €
195210-3	HR4501C/HR4510C/HR4511C	26,99 €
193284-8	HR5000	21,23 €
193392-5	HR5001C	27,66 €
195191-1	HR5201C/HR5210C/HR5211C	24,28 €
196865-7	HR5212C	35,63 €
193397-5	HK0500	16,64 €
193394-1	HK1800/HK1810	16,15 €
195194-5	HK1820/L	19,33 €
193242-4	HM0810/T/B	28,45 €
195200-6	HM0830/T	18,54 €
195204-8	HM0860C	30,14 €
195113-1	HM0870C/HM0871C	30,01 €
193243-2	HM1100/C	18,06 €
193405-2	HM1130/C	23,77 €
193244-0	HM1200/B	27,11 €
193391-7	HM1202C	27,49 €
195114-9	HM1203C/HM1205C/HM1213C/ HM1214C	31,22 €
193393-3	HM1303/B	24,04 €
195201-4	HM1304/B	26,94 €
195203-0	HM1305	14,74 €
195103-4	HM1307C/17/C/CB	18,92 €
193399-1	HM1400	44,56 €
193403-6	HM1500	27,60 €
193402-8	HM1800	31,35 €
195205-6	HM1801/1810	30,96 €

Sady môžu mať iný obsah závislý od modelu.

# Poznámky

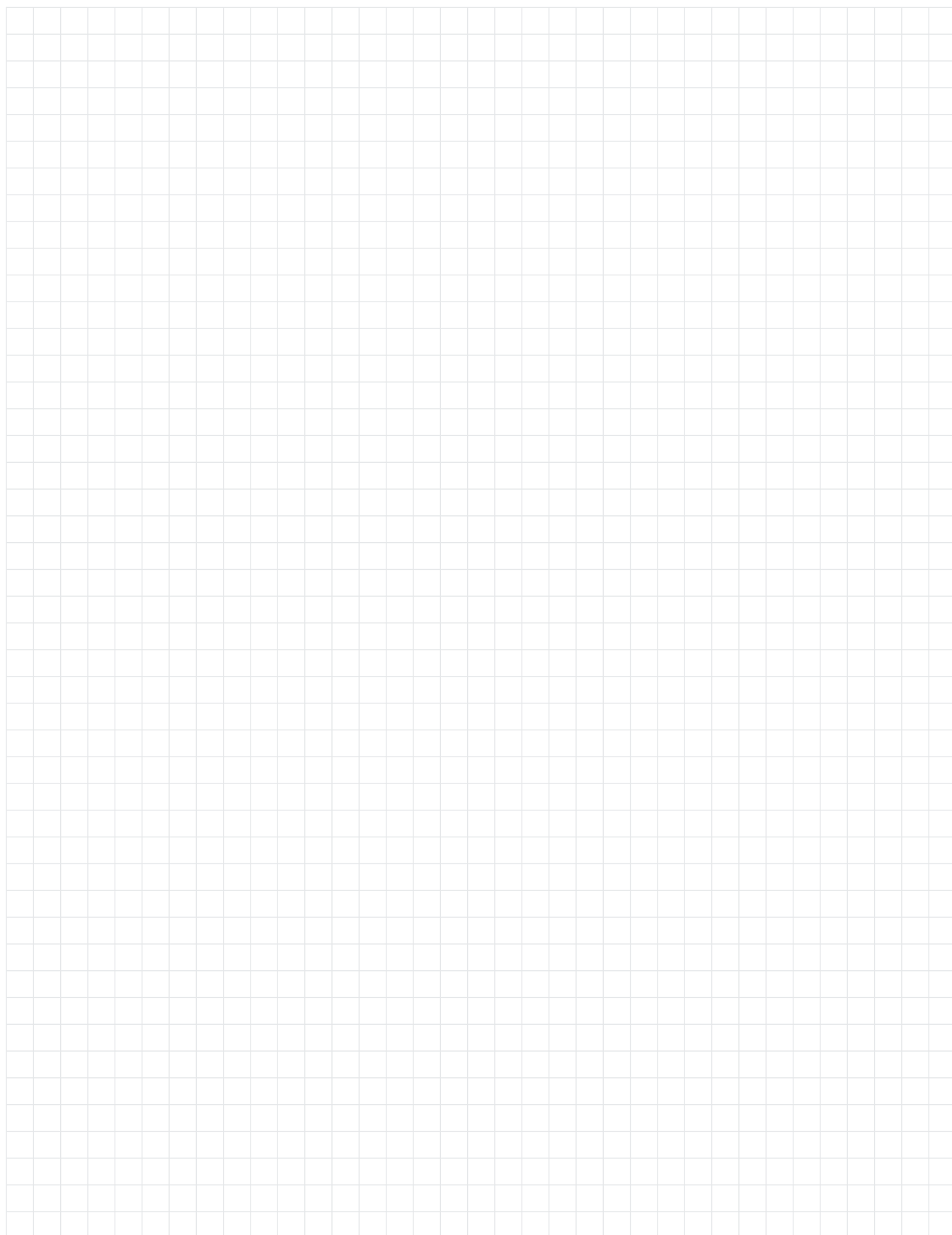
A large, empty grid of small squares occupies the central portion of the page, intended for taking notes. The grid is composed of approximately 30 columns and 40 rows of squares.

# Poznámky

A large grid of graph paper for taking notes, consisting of 20 columns and 30 rows of small squares.



# Poznámky

A large grid of graph paper for taking notes, consisting of 20 columns and 40 rows of small squares.

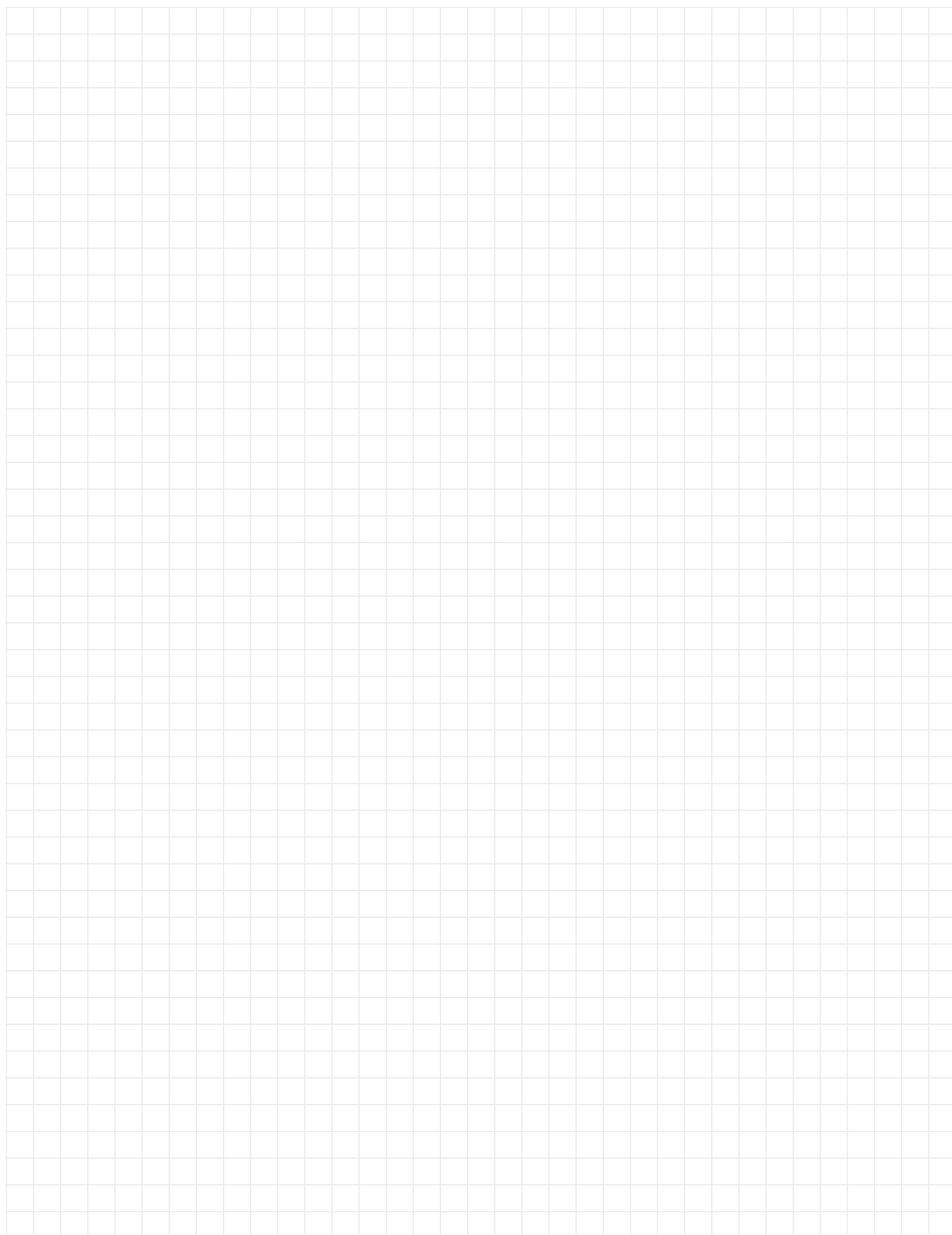

# Poznámky

A large, empty grid of small squares occupies the central portion of the page, intended for taking notes. The grid is composed of approximately 30 columns and 40 rows of squares.

# Poznámky

A large grid of graph paper for taking notes, consisting of 20 columns and 30 rows of small squares.

# Poznámky

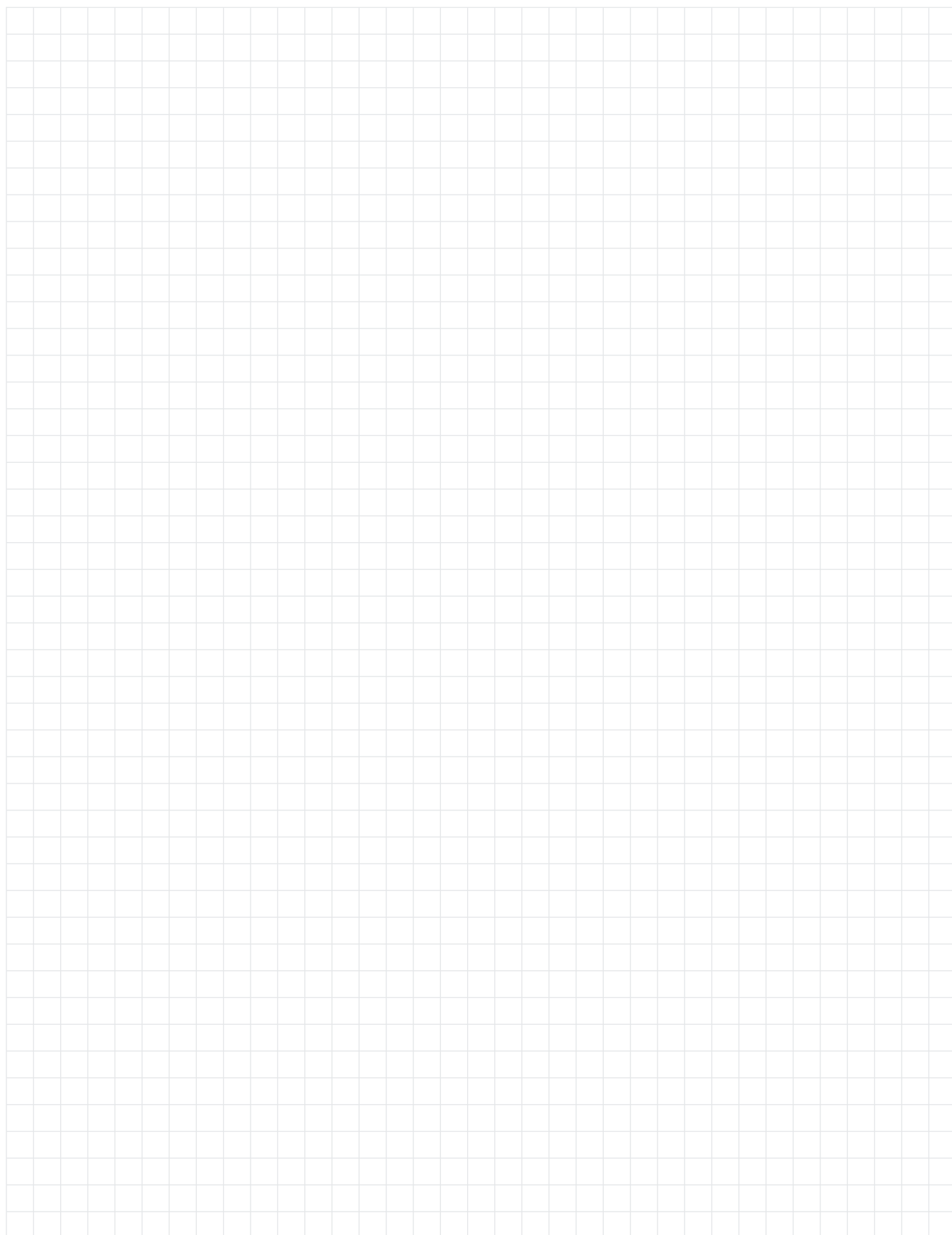
A large, empty grid area occupies the central portion of the page, intended for taking notes. The grid is composed of small, uniform squares, typical of graph paper.

## SORTIMENT PRÍSLUŠENSTVA



Spoločnosť Makita si vyhradzuje právo kedykoľvek vykonávať zmeny ponuky bez predchádzajúceho upozornenia. Ponuky sú k dispozícii do vypredania skladových zásob. Obrázky sú ilustračné a oproti skutočnosti sa môžu líšiť.



**Makita s. r. o.**  
Jegorovova 35  
974 01 Banská Bystrica  
Web: [www.makita.sk](http://www.makita.sk)

Tel.: 048 – 4161 772  
Fax: 048 – 4161 769  
Servis: 048 – 4161 774  
E-mail: [makita@makita.sk](mailto:makita@makita.sk)